

CONTENTS

INTRODUCTION	7
Symbols used in these instructions	7
Letters in brackets	7
Troubleshooting and repairs	7
SAFETY	7
Fundamental safety warnings	7
Designated use	8
Instructions	8
DESCRIPTION	8
Description of the appliance	8
Description of the control panel	8
Description of milk container and accessories	9
PRELIMINARY CHECKS	9
Controls after transport	9
Installing the appliance	9
Connecting the appliance	9
DISPOSAL	9
BUILT-IN INSTALLATION	10
USING THE APPLIANCE FOR THE FIRST TIME	12
Installing the filter	12
Replacing the filter ("Filter reset")	13
Removing the filter	13
TURNING ON AND HEATING UP	13
MAKING COFFEE USING COFFEE BEANS	14
Rinsing	14
CHANGING THE QUANTITY OF COFFEE IN THE CUP	15
ADJUSTING THE COFFEE MILL	15
MAKING ESPRESSO COFFEE WITH PRE-GROUNDED COFFEE (INSTEAD OF BEANS)	16
DELIVERING HOT WATER	16
CHANGING THE QUANTITY OF HOT WATER	16

MAKING CAPPUCCINO	16
CHANGING THE QUANTITY OF MILK AND COFFEE FOR CAPPUCCINO	17
Changing the quantity of milk	17
Changing the quantity of coffee	18
CLEANING	18
Cleaning the coffee maker	18
Cleaning the waste coffee container	18
Cleaning the drip tray	18
Cleaning the water tank	18
Cleaning the spouts	18
Cleaning the pre-ground coffee funnel	18
Cleaning the inside of the coffee maker ...	19
Cleaning the brewing unit	19
Cleaning the milk container	19
CHANGING AND SETTING MENU PARAMETERS	20
Setting the language	20
Rinsing	20
Changing the length of time the appliance remains on	20
Setting the clock	21
Setting auto-start time	21
Auto start	21
Changing coffee temperature	21
Setting water hardness	21
Programming coffee	21
Programming cappuccino	22
Programming water	22
Descaling	22
Resetting default values (reset)	22
Statistics	22
Buzzer	23
Adjusting contrast	23
Water filter	23
TURNING THE APPLIANCE OFF	23
TECHNICAL SPECIFICATION	23
ELECTRICAL CONNECTION (UK ONLY)	24
DISPLAYED MESSAGES	25
TROUBLESHOOTING	27

INTRODUCTION

Symbols used in these instructions

Important warnings are identified by these symbols. Failure to observe the instructions could result in electric shock, serious injury, burns, fire or damage to the appliance.



Danger!

Failure to observe the warning could result in possibly life threatening injury from electric shock.



Important!

Failure to observe the warning could result in injury or damage to the appliance.



Danger of burns!

Failure to observe the warning could result in scalds or burns.



N.B.!

Important information for the user

Letters in brackets

The letters in brackets refer to the legend in the Description of the Appliance on page 3.

Troubleshooting and repairs

In the event of problems, follow the information given in the sections "Displayed messages" and "Troubleshooting".

If this does not resolve the problem, you should consult Customer Services.

For repairs, contact Customer Services only.

SAFETY

Fundamental safety warnings



Important! This is an household appliance only.

It is not intended to be used in:

- staff kitchen areas in shops, offices and other

working environments;

- farm houses;
- by clients in hotels, motels and other residential type environments;
- bed and breakfast type environments.



Danger! This is an electrical appliance, it is therefore important to respect the following safety warnings:

- Never touch the appliance with damp hands.
- Never touch the plug with damp hands.
- Make sure the socket used is freely accessible at all times, enabling the appliance to be unplugged when necessary.
- Unplug directly from the plug only. Never pull the power cable as you could damage it.
- To disconnect the appliance completely, place the main switch (A23) on the side of the appliance in the 0 position.
- If the appliance is faulty, do not attempt to repair. Turn it off using the main switch (A23), unplug from the mains socket and contact Customer Services.
- If the plug or power cable is damaged, it must be replaced by customer services only to avoid all risk.



Important! Keep all packaging (plastic bags, polystyrene foam) away from children.



Important! The appliance is not intended for use by persons (including children) with reduced physical, sensory or mental capabilities, or lack of experience and knowledge, unless they have been given supervision or instruction concerning use of the appliance by a person responsible for their safety.

Children must be supervised to ensure they do not play with the appliance.



Danger of burns! This appliance produces hot water and steam may form while it is in operation.

Avoid contact with splashes of water or hot steam. Use knobs and handles.



Important! Do not grasp the coffee maker when it is out of the cabinet. Do not rest recipients containing liquids or inflammable or corrosive materials on top of the appliance. Place the accessories required to make the coffee (the measure for example) in the special holder. Do not rest large objects which could obstruct movement or unstable objects on the appliance.



Important! Do not use the appliance when extracted. Make sure the appliance is inactive before extracting it. The only exception is adjusting the coffee mill which must be done with the machine out (see the section "Adjusting the coffee mill").



N.B.! Use original or manufacturer recommended accessories and spare parts only.

Designated use

This appliance is designed and made to prepare coffee and heat drinks. All other use is considered improper. This appliance is not suitable for commercial use. The manufacturer is not liable for damage deriving from improper use of the appliance. This appliance can be installed over a built-in oven if the latter is fitted with a cooling fan at the rear (maximum microwave power: 3 kW).

Instructions

Read these instructions carefully before using the appliance.

- Keep these instructions
- Failure to respect these instructions may result in burns or damage to the appliance.

The manufacturer is not liable for damage deriving from failure to respect these instructions.



N.B.! The appliance has a cooling fan. This comes on whenever coffee, steam or hot water is delivered. After several minutes, the fan goes off automatically.

DESCRIPTION

Description of the appliance

(page 3 - A)

- A1. Cup tray
- A2. Service door
- A3. Coffee guide
- A4. Waste coffee container
- A5. Brewing unit
- A6. Cup tray lights
- A7. On-Off/stand-by button
- A8. Control panel
- A9. Water softener filter (optional)
- A10. Hot water and steam nozzle
- A11. IEC connector
- A12. Water tank
- A13. Coffee spout (adjustable height)
- A14. Drip tray
- A15. Bean container lid
- A16. Bean container
- A17. Grinding adjustment knob
- A18. Pre-ground coffee funnel door
- A19. Measure
- A20. Compartment for measure
- A21. Pre-ground coffee funnel
- A22. Power cable
- A23. Main switch
- A24. Tray

Description of the control panel



(page 3 - B)











N.B.! Only the icons relating to the controls enabled for the particular function currently being used will be lit on the touch screen.



N.B.! A light touch is enough to activate the icon.

- B1. Display: guides the user in using the appliance.
- B2. SET icon to activate or deactivate menu parameter setting mode
- B3.  icon rinse
- B4.  icon to select the coffee taste
- B5.  icon to select the type of coffee (espresso, small cup, medium cup, large)

cup, mug)

- B6.  icon to exit the selected mode
 B7-B8.   icons to scroll forwards or backwards through the menu and display the various modes
 B9.  icon to confirm the selected function
 B10.  icon to deliver a cup of coffee
 B11.  icon to deliver two cups of coffee
 B12.  icon to deliver cappuccino
 B13.  icon to deliver hot water

Description of milk container and accessories

(page 3 - C)

- C1. Frothed milk regulator
 C2. Milk container handle
 C3. CLEAN button
 C4. Milk intake tube
 C5. Frothed milk spout
 C6. Milk frother
 C7. Hot water spout

PRELIMINARY CHECKS

Controls after transport

After removing the packaging, make sure the product is complete and undamaged and that all accessories are present.

Do not use the appliance if it is visibly damaged. Contact Customer Services.

Installing the appliance



Important!

- Installation must be performed by a qualified professional in compliance with legislation in force in the country of installation (see Built-in installation).
- The packing elements (plastic bags, polystyrene foam, etc.) should be kept out of reach of children.
- Do not install the appliance in rooms where the temperature may drop to 0°C or lower.
- Customise the water hardness as soon as possible following the instructions in the

"Setting water hardness" section.

Connecting the appliance



Danger! Check that the mains power supply voltage corresponds to the value indicated on the rating plate on the bottom of the appliance.

Connect the appliance to an efficiently earthed and correctly installed socket with a minimum current rating of 10A only.

If the power socket does not match the plug on the appliance, have the socket replaced with a suitable type by a qualified professional.

To comply with safety directives, an omnipolar switch with a minimum contact distance of 3 mm must be installed.

Do not use multiple sockets or extensions.



Important! Safety cutout devices must be included in the mains power supply in compliance with the installation regulations in the country concerned.

DISPOSAL



In compliance with European directive 2002/96/EC, the appliance must not be disposed of with household waste, but taken to an authorised waste separation and recycling centre.

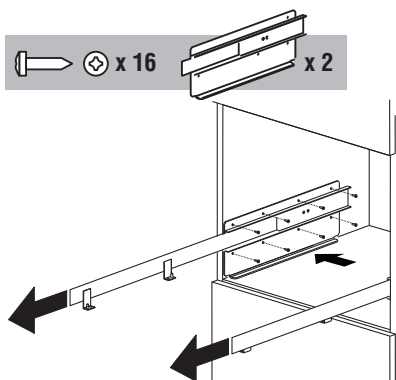

Position the rails on the sides of the cabinet as shown in the figure. Fix with the screws supplied, then extract them completely. If the coffee maker is installed over a warmer drawer, use the top surface of this as a reference to position the rails.

In this case, there will be no surface to rest the rails on.

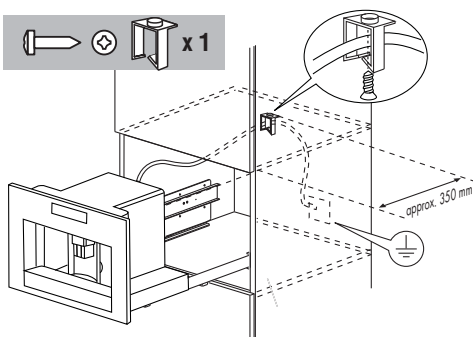

Fix the power cable with the clip.

The power cable must be long enough to allow the appliance to be extracted from the cabinet to fill the coffee bean container.

The appliance must be earthed in compliance with legislation.

Electrical connections must be performed by a qualified electrician following the instructions.

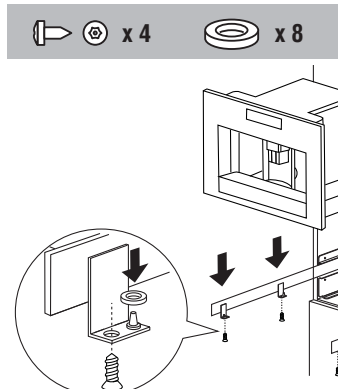

Position the appliance on the rails, making sure the pins are correctly inserted in the housings, then fix it with the screws supplied.

If the height of the appliance requires adjusting, use the spacer disks provided.

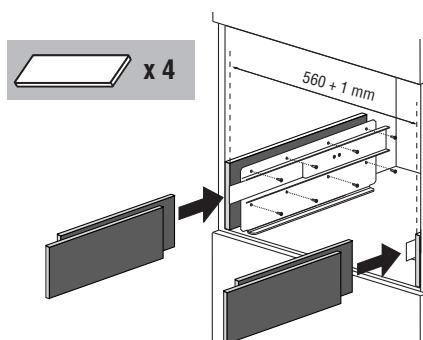

If necessary, correct alignment of the appliance by positioning the spacers supplied under or at the sides of the support.

USING THE APPLIANCE FOR THE FIRST TIME

- Coffee has been used to factory test the appliance and it is therefore completely normal for there to be traces of coffee in the mill.
 - Customise water hardness as soon as possible following the instructions in the "Setting water hardness" section.
1. Connect the appliance to the mains supply. Set the required language.
 2. To set the language, use the < > icons (B7 and B8) to choose the required language (fig. 2). When the message "PRESS OK TO CHOOSE ENGLISH" is displayed, press the OK icon (B9) (fig. 3) for 3 seconds until "ENGLISH INSTALLED" is displayed. If you set the wrong language, follow the instructions in the "Setting the language" section. If your language is not available, select one from those displayed. The instructions refer to the English version. Then follow the instructions displayed:
 3. After 5 seconds, the appliance displays "FILL TANK". Extract the water tank (fig. 4), rinse and fill with fresh water without exceeding the MAX line. Replace and push as far as it will go. A water softener filter can be installed in the tank (fig. 30).
 4. Place a cup under the hot water spout (fig. 5). (If the hot water spout is not inserted, the appliance displays "INSERT WATER SPOUT". Attach it as shown in figure 6. The appliance displays: "HOT WATER PRESS OK". Press the OK icon (B9) (fig. 3) and after a few seconds a little water comes out of the spout.
 5. The machine now displays "TURNING OFF.. PLEASE WAIT" and goes off.
 6. Extract the appliance by pulling it out using the handles (fig. 7). Open the lid and fill the container with coffee beans, then close the lid and push the appliance in.

The coffee maker is now ready for normal use.

! **Important!** Never introduce pre-ground coffee, freeze dried coffee, caramelised beans or anything else which could damage the appliance.

i **N.B.!** When using the appliance for the first time, you need to make 4-5 cups of coffee and 4-5 cappuccinos before the appliance gives satisfactory results.

i **N.B.!** Each time you turn the coffee maker on by the ON/OFF switch (A23), it performs a SELF-DIAGNOSIS cycle and then goes off. To turn it on again, press the ON/OFF button (A7) (fig. 1)

Installing the filter

Some models are fitted with a water softener filter to improve the quality of the water used and extend the working life of the appliance.

To install, proceed as follows:

1. Remove the filter (A9) from the packaging;
2. Slide the date indicator pointer (see fig. 30) until the months of use are displayed.

i **N.B.!** The filter lasts about two months if the appliance is used normally. If the coffee maker is left unused with the filter installed, it will last a maximum of three weeks.

3. Fill the tank with a little water up to the level shown in the figure:



4. Insert the filter in the water tank and press it until it touches the bottom of the tank (see fig. 30);
5. Fill the water tank and place it in the coffee maker, then insert the hot water spout (C7) (fig. 6).
6. Position a container under the spout (min. capacity: 100 ml).
7. Press the SET icon (B2) to enter the menu;
8. Press the < > icons (B7) and (B8) until "INSTALL FILTER" is displayed;
9. Press the OK icon (B9);
10. The message "INSTALL FILTER PLEASE CONFIRM" is displayed.
11. Press the ← icon (B9) to confirm the selec-

tion (or ← (B6) to cancel). "HOT WATER PRESS OK" is displayed.

- Press the OK icon (B9) again. The appliance begins delivering hot water and the message "PLEASE WAIT..." is displayed.

When delivery stops, the appliance automatically displays the basic modes set again.



N.B.! The appliance may request the operation to be repeated a number of times until the air is completely eliminated from the hydraulic circuit.

Replacing the filter ("Filter reset")

When "REPLACE FILTER" is displayed or after 2 months of use (see date indicator), the filter must be replaced:

- Remove the exhausted filter;
- Remove the new filter from the packaging.
- Slide the pointer of the date indicator (see fig. 30) until the months of use are displayed (the filter lasts about 2 months);
- Insert the filter in the water tank and press it until it touches the bottom of the tank (see fig. 30);
- Fill the water tank and place it in the coffee maker, then insert the hot water spout (C7) (fig. 6).
- Position a container under the spout (min. capacity: 100 ml).
- Press the SET icon (B2) to enter the menu;
- Press the < > icons (B7) and (B8) until "FILTER RESET" is displayed;
- Press the OK icon (B9);
- The message "FILTER RESET CONFIRM" is displayed.
- Press the OK icon (B9) to confirm the selection (or ← (B6) to cancel). "HOT WATER PRESS OK" is displayed.
- Press the OK icon (B9) again. The appliance begins delivering hot water and the message "PLEASE WAIT..." is displayed.

When delivery stops, the appliance automatically displays the basic modes set again.

Removing the filter

To use the appliance without a filter, you must remove it and notify the appliance of its removal as follows:

- Press the SET icon (B2) to enter the menu;
- Press the < > icons (B7) and (B8) until "INSTALL FILTER*" is displayed;
- Press the OK icon (B9);
- The message "INSTALL FILTER* CONFIRM" is displayed.
- Press the ← icon (B6).
- When the asterisk has disappeared from the top right of the display, press ←(B6) to exit the menu.



N.B.! Use the filters recommended by the manufacturer only. Use of unsuitable filters could damage the appliance.

TURNING ON AND HEATING UP

Each time the appliance is turned on, it performs an automatic preheat and rinse cycle which cannot be interrupted.

The appliance is ready for use only after completion of this cycle.



Danger of burns! During rinsing, a little hot water flows from the coffee spouts.

To turn the appliance on, press the On-Off/stand-by button (A7) (fig. 1). The message "HEATING UP... PLEASE WAIT" is displayed.

When heating is complete, the message changes to "RINSING";

The appliance is at temperature when the message "MEDIUM CUP NORMAL TASTE" is displayed. If no icon is pressed within about 2 minutes, the time (if set, see the "Setting the clock" section) is displayed.

If the time has not been set, the appliance displays the last functions set.

When any icon is pressed, "MEDIUM CUP NORMAL TASTE" is displayed again. The appliance is ready to make coffee again.

MAKING COFFEE USING COFFEE BEANS

1. The appliance is preset to make coffee with a normal taste.

You can also choose coffee with an extra-mild, mild, standard, strong or extra-strong taste. There is also a pre-ground coffee option.

To choose the required taste, press more times the ☉ icon (B4) (fig. 8). The required coffee taste is displayed.

2. Place 1 cup under the spouts to make 1 coffee (fig. 9) or 2 cups for 2 coffees (fig. 9). Lower the spouts as near as possible to the cup for a creamier coffee (fig. 10).

3. Press the ☕ icon (B5) (fig. 11) to select the type of coffee: espresso, small cup, medium cup, large cup, mug.

Press the ☕ icon (B10) (fig. 12) if you want to make a coffee and the ☕ icon (B11) (fig. 13) if you want to make 2 coffees. The appliance now grinds the beans and starts delivering the coffee into the cup.

Once the set amount of coffee has been delivered, the machine stops delivery automatically and expels the exhausted waste coffee into the waste coffee container.

4. After a few seconds, the appliance is ready for use again.

5. To turn the appliance off, press the On-Off/stand-by button (A7) (fig. 1).

(Before going off, the appliance performs an automatic rinse cycle. Take care to avoid scalds).

NOTE 1: If the coffee is delivered a drop at a time or not at all, see the "Adjusting the coffee mill" section.

NOTE 2: If the coffee is delivered too fast and the cream is not satisfactory, see the "Adjusting the coffee mill" section.

NOTE 3: Tips for a hotter coffee:

Rinsing

- When you turn the appliance on, if you want to make a small cup of coffee (less than 60

cc), preheat the cup by rinsing it with hot water.

- If on the other hand more than 2/3 minutes have passed since the last coffee was made, before requesting another coffee, you must preheat the brewing unit by pressing the ☺ icon (B3). Deliver the water into the underlying drip tray or alternatively use this water to fill (and then empty) the cup to be used for the coffee to preheat it.
- Unless preheated, do not use excessively thick cups as they will absorb too much heat.
- Preheat the cups by rinsing them with hot water.

NOTE 4: Coffee delivery can be interrupted at any moment by re-pressing the previously selected icon which remains lit during the operation.

NOTE 5: As soon as delivery is finished, to increase the quantity of coffee in the cup, just keep pressing the previously selected icon within 3 seconds after delivery has finished.

NOTE 6: When the appliance displays "FILL TANK", fill the tank with water or the appliance will not deliver coffee.

(It is normal for there to be a little water left in the tank).

NOTE 7: After about 14 single (or 7 double) coffees, the appliance displays "EMPTY WASTE COFFEE CONTAINER". Even if not full, the empty waste coffee container message is displayed 72 hours after the first coffee has been delivered. For the 72 hours to be calculated correctly, the machine must never be turned off with the main switch in the 0 position. To clean, open the service door on the front of the appliance by pulling the spout (fig. 16), extract the drip tray (fig. 17) and clean.

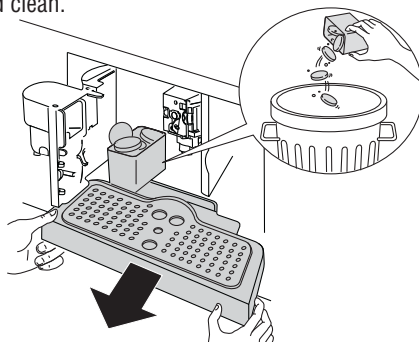

When cleaning, **always extract the drip tray completely.**



Important! When extracting the drip tray, the waste coffee container **MUST** always be emptied. If this is not done, the machine may be clogged.

NOTE 8: Never extract the water tank while the machine is delivering coffee.

If it is removed, it will not be possible to make the coffee and the appliance will display "GROUND TOO FINE ADJUST MILL AND PRESS OK" and then "FILL TANK!". Check the level of water in the tank and replace in the appliance.

To use the appliance again, insert the hot water spout (fig. 6) if not already in position, press the OK icon (B9). "HOT WATER PRESS OK" is displayed.

Press the OK icon (B9) within a few seconds and deliver water from the spout for about 30 seconds. When delivery stops, the basic modes are displayed again.



N.B.: The coffee maker may request the operation to be repeated a number of times until the air is completely eliminated from the hydraulic circuit.



N.B.: if this operation is not performed correctly or if the machine is turned off, the basic modes may be displayed, although the problem is in fact still present.

CHANGING THE QUANTITY OF COFFEE IN THE CUP

The appliance is set by default to automatically make the following types of coffee:

- espresso
- small cup
- medium cup
- large cup
- mug

To change the quantity, proceed as follows:

- Press the SET icon (B2) to enter the menu

(fig. 15). Press the < > icons (B7) and (B8) (fig. 2) until "PROGRAM COFFEE" is displayed.

- Press the OK icon (B9).
- Select the type of coffee you want to change by pressing the < > icons (B7) and (B8).
- Press the OK icon (B9) to confirm the type of coffee you want to make.
- Use the < > icons (B7) and (B8) to change the quantity of coffee. The progress bar shows the quantity of coffee selected.
- Press the OK icon (B9) again to confirm (or the ← icon (B6) to cancel the operation).
- Press the ← icon (B6) (fig. 18) twice to exit the menu.

The appliance is now reprogrammed with the new settings and is ready.

ADJUSTING THE COFFEE MILL

The coffee mill is preset in the factory and should not require adjusting. However, if after making the first few coffees you find that delivery is either too fast or too slow (a drop at a time), this can be corrected by adjusting the grinding adjustment knob (fig. 14).



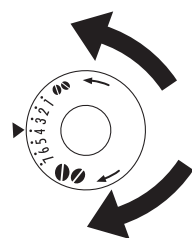

Important! The grinding adjustment knob must only be turned when the coffee mill is in operation.



For slower delivery and creamier coffee, turn one click anticlockwise (finer pre-ground coffee).

For faster delivery (not a drop at a time), turn one click clockwise (coarser pre-ground coffee).

MAKING ESPRESSO COFFEE WITH PRE-GROUND COFFEE (INSTEAD OF BEANS)

- Press the  icon (B4) (fig. 8) and select the pre-ground coffee function.
- Extract the machine by pulling it outwards using the handles (fig. 7).
- Lift the central lid, place one measure of pre-ground coffee in the funnel (fig. 19), push the appliance in then proceed as described in the section "Making coffee using coffee beans". N.B.: You can make just one coffee at a time by pressing the  icon (B10) (fig. 12).
- After using the machine with pre-ground coffee, to go back to making coffee using beans, deactivate the pre-ground coffee function by pressing the  icon (B4) (fig. 8).

NOTE 1: Never introduce pre-ground coffee when the machine is off or it could spread through the inside of the appliance.

NOTE 2: Never add more than 1 measure, otherwise the appliance will not make the coffee.

NOTE 3: Use the measure provided only.

NOTE 4: Introduce only pre-ground coffee for espresso coffee machines into the funnel.

NOTE 5: If more than one measure of pre-ground coffee is used and the funnel clogs, push the coffee down with a knife (fig. 21) then remove and clean the brewing unit and machine as described in the "Cleaning the brewing unit" section.

DELIVERING HOT WATER

- Always make sure the appliance is ready.
- Make sure the water spout is in place and attached to the nozzle (fig. 6).
- Position a container under the spout.
- Press the  icon (B13) (fig. 20). The appliance displays: "HOT WATER PRESS OK".

Press the OK icon (B9) again and hot water is delivered from the water spout into the container underneath.

You should not deliver hot water for more than 2 minutes at a time.







To interrupt, press the  icon (B13) or the  icon (B6).

The appliance stops delivery once the set quantity is reached.

CHANGING THE QUANTITY OF HOT WATER

The machine is set by default to automatically deliver 150 ml of hot water.

To change these quantities, proceed as follows:

- Place a container underneath the water spout (fig. 5).
- Press the SET icon (B2) to enter the menu (fig. 15) or press the   icons (B7) and (B8) (fig. 2) until "PROGRAM HOT WATER" is displayed.
- Press the OK icon (B9) to confirm.
- Select the required quantity of water by pressing the   icons (B7) and (B8). The progress bar shows the quantity of water selected.
- Press the OK icon (B9) to confirm (or the  icon (B6) to cancel the operation.
- Press the  icon (B6) (fig. 18) twice to exit the menu.
- The appliance is now reprogrammed with the new settings and is ready.

MAKING CAPPUCCINO

 **N.B.:** Set the quantity of coffee you want to use to make the cappuccino in the "Program cappuccino" function in the menu.

- Select the taste of the coffee you want to use to make the cappuccino by pressing the  icon (B4).
- Remove the lid of the milk container.
- Fill the container with about 100 grams of milk for each cappuccino to be prepared (fig. 23). Never exceed the MAX level (corresponding to about 750 ml) marked on the container.

You should ideally use skimmed or semi-

skimmed milk at refrigerator temperature (about 5°C).

- Make sure the intake tube is correctly inserted in the rubber washer (fig. 24) then replace the milk container lid.
- Position the frothed milk regulator (C1) between the words CAPPUCCINO and CAFFELATTE printed on the milk container lid.

The quantity of froth can be adjusted by moving the regulator towards the word CAFFELATTE for a denser froth. Moving it towards the word CAPPUCCINO obtains a less dense froth.

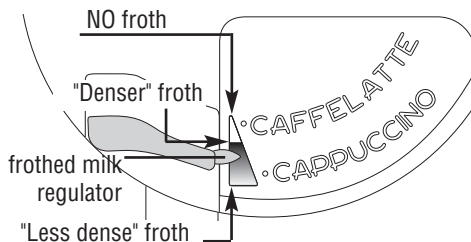

- Remove the hot water spout (fig 6) and attach the milk container to the nozzle (fig. 25).
- Position the milk spout as shown in fig. 26 and then place a sufficiently large cup under the coffee and milk spouts.
- Press the ☕ icon (fig. B12). "CAPPUCCINO..." is displayed and after a few seconds, frothed milk flows out of the milk spout into the cup below. (Delivery stops automatically).
- The appliance delivers coffee.
- The cappuccino is now ready. Sweeten to taste and, if desired, sprinkle the froth with a little cocoa powder.

NOTE 1: While making cappuccino, the flow of frothed milk or coffee can be interrupted by pressing the ☕ icon (B12).

NOTE 2: If the milk in the container finishes while delivering frothed milk, remove the container and add milk. Then re-attach it and press the ☕ icon (B12) to request cappuccino again.

NOTE 3: To ensure the complete cleanliness and hygiene of the milk frother, always clean the circuits in the milk container lid after making cap-

puccino. "PRESS CLEAN!" flashes on the display.

- Place a recipient under the milk spout (fig. 26).
- Press the CLEAN button on the lid (C3) and hold down for at least 5 seconds (fig. 26) to start the cleaning function. The appliance displays the message "CLEANING" above a progressive bar.

You should not release the CLEAN button until the bar is complete indicating that cleaning is concluded.

When the CLEAN button is released, the function stops.

After cleaning, remove the milk container and place in the refrigerator. The milk should not be left out of the refrigerator for more than 15 minutes.

NOTE 4: To change the quantity of coffee or frothed milk the appliance delivers automatically into the cup, proceed as described in the section "Changing the quantity of coffee and milk for cappuccino".



CHANGING THE QUANTITY OF MILK AND COFFEE FOR CAPPUCCINO

The appliance is set by default to automatically deliver a standard cappuccino.









To change these quantities, proceed as follows:

Changing the quantity of milk

- Fill the container with milk up to the maximum level indicated on the container.
- Press the SET icon (B2) to enter the menu (fig. 15), then press the < > icons (B7) and (B8) (fig. 2) until "PROGRAM CAPPUCCINO" is displayed.
- Press the OK icon (B9) to confirm. "PROGRAM MILK" is displayed.
- Press the OK icon (B9) again.
- Select the quantity of milk required by pressing the < > icons (B7) and (B8). The progress bar shows the quantity of milk selected.
- Press the OK icon (B9) to confirm (or the

- Press the  icon (B6) to cancel the operation).
- Press the  icon (B6) (fig. 18) twice to exit the menu.

Changing the quantity of coffee

- Press the SET icon (B2) to enter the menu (fig. 15) or press the   icons (B7) and (B8) (fig. 2) until "PROGRAM CAPPUCCINO" is displayed.
- Press the OK icon (B9) to confirm then the   icons (B7) and (B8) (fig. 2) until "COFFEE FOR CAPPUCC." is displayed.
- Press the OK icon (B9) again.
- Select the quantity of coffee required by pressing the   icons (B7) and (B8).
The progress bar shows the quantity of coffee selected.
- Press the OK icon (B9) to confirm (or the  icon (B6) to cancel the operation).
- Press the  icon (B6) (fig. 18) twice to exit the menu.

CLEANING

Cleaning the coffee maker

Do not use solvents or abrasive detergents to clean the coffee maker. A soft damp cloth will suffice.

Never wash any of the components of the coffee maker in the dishwasher.

The following parts of the machine must be cleaned regularly:

- Waste coffee container (A4).
- Drip tray (A14).
- Water tank (A12).
- Coffee spouts (A13)
- Pre-ground coffee funnel (A21).
- Inside of the machine, accessible after opening the service door (A2).
- Brewing unit (A5).

Cleaning the waste coffee container

When "EMPTY WASTE COFFEE CONTAINER" is displayed, the waste coffee container must be

emptied and cleaned. To clean:

- open the service door on the front of the appliance (fig. 16), extract the drip tray (fig. 17) and clean.
- Clean the waste coffee container thoroughly.



Important! When extracting the drip tray, the waste coffee container must always be emptied.

Cleaning the drip tray



Important! If the drip tray is not emptied the water might overflow. This could damage the machine. The drip tray is fitted with a level indicator (red) showing the level of water it contains (fig. 28). Before the indicator protrudes from the cup tray, the drip tray must be emptied and cleaned. To remove the tray:

1. Open the service door (fig. 16).
2. Remove the drip tray and the waste coffee container (fig. 17).
3. Clean the drip tray and waste coffee container (A4).
4. Replace the drip tray and waste coffee container (A4).
5. Close the service door.

Cleaning the water tank

1. Clean the water tank (A12) regularly (about once a month) with a damp cloth and a little mild washing up liquid.
2. Remove all traces of washing up liquid.

Cleaning the spouts

1. Clean the nozzles periodically using a sponge (fig. 29).
2. Check regularly that the holes in the coffee spout are not blocked.
If necessary, remove coffee deposits with a toothpick (fig. 27).

Cleaning the pre-ground coffee funnel

- Check regularly (about once a month) that

the pre-ground coffee funnel is not blocked (fig. 21).

⚠ Danger! Before performing any cleaning operations, the machine must be turned off by pressing the main switch (A23) and unplugged from the mains power supply. Never immerse the coffee maker in water.

Cleaning the inside of the coffee maker

1. Check regularly (about once a week) that the inside of the appliance is not dirty. If necessary, remove coffee deposits with a sponge.
2. Remove the residues with a vacuum cleaner (fig. 31).

Cleaning the brewing unit

The brewing unit must be cleaned at least once a month.

⚠ Important! The brewing unit (A5) must not be removed when the appliance is on. Do not use force to remove the brewing unit.

1. Make sure the machine is correctly turned off (see "Turning the appliance off").
2. Open the service door (fig. 16).
3. Remove the drip tray and waste coffee container (fig. 17);
4. Press the two red release buttons inwards and at the same time pull the brewing unit outwards (fig. 32).

⚠ Important! Do not use washing up liquid to clean the brewing unit. It would remove the lubricant applied to the inside of the piston.

5. Soak the brewing unit in water for about 5 minutes, then rinse.
6. After cleaning, replace the brewing unit (A5) by sliding it onto the internal support and pin at the bottom, then push the PUSH symbol fully in until it clicks into place.

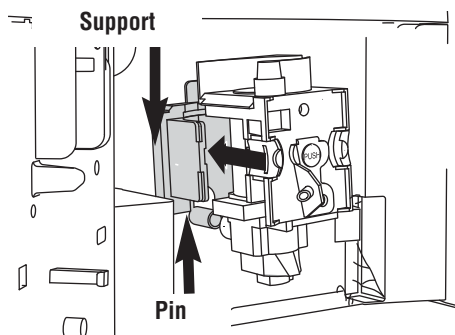

i N.B.! If the brewing unit is difficult to insert, you must first adapt it to the right dimensions by pressing it forcefully from the bottom and top as shown in the figure.

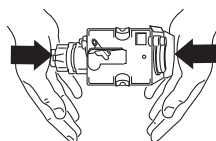

7. Once inserted, make sure the two red buttons have snapped out.

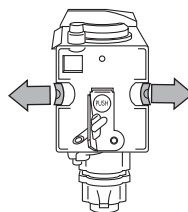

8. Replace the drip tray and waste coffee container.
9. Close the service door.

Cleaning the milk container

⚠ Important! Always clean the tubes inside the milk container (C) when you prepare milk. If there is still milk in the container, do not leave it out of the refrigerator for longer than strictly necessary. Clean the container each time you prepare milk as described in Note 3 in the section "Making cappuccino". All components can be wa-

shed in a dishwasher, placing them in the top basket of the dishwasher.

1. Turn the milk container lid clockwise then remove it.
2. Remove the milk spout and intake tube.

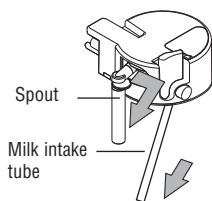

3. Remove the frothed milk regulator by pulling it outwards.
4. Wash all the components thoroughly with hot water and mild washing-up liquid.

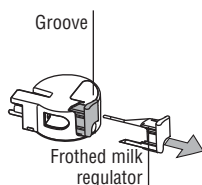

Make sure there are no milk residues left inside the holes and the groove on the fine end of the frothed milk regulator.

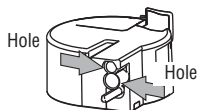

5. Check that the intake tube and spout are not clogged with milk residues.
6. Replace the frothed milk regulator, milk spout and intake tube.
7. Replace the milk container lid.

CHANGING AND SETTING MENU PARAMETERS

When the appliance is ready, you can use the internal menu to modify the following parameters and functions:

- Choose language
- Shut-off time
- Set clock
- Start time
- Auto-start

- Temperature
- Water hardness
- Program coffee
- Program cappuccino
- Program water
- Descale
- Reset to default
- Statistics
- Install filter
- Reset filter
- Buzzer
- Contrast

Setting the language

To change the language on the display, proceed as follows:

- Press the SET icon (B2) to enter the menu. "CHOOSE LANGUAGE" is displayed.
- Press the OK icon (B9).
- Press the < > icons (B7) and (B8) until the required language is displayed.
- Press the OK icon (B9) to confirm.
- Press the ← icon (B6) to exit the menu.



N.B.! If you choose the wrong language, you can access the menu directly to modify the parameter.

- Press the SET icon button (B2) for at least 7 seconds until the appliance displays the various languages.
- Choose the required language as described in the section "Using the appliance for the first time".

Changing the length of time the appliance remains on

The appliance is set by default to go off automatically 30 minutes after the last coffee has been made. To change this interval (max. 120 min), proceed as follows:

- Press the SET icon (B2) to enter the menu and then the < > icons (B7) and (B8) until "SHUT-OFF TIME" is displayed.
- Press the OK icon (B9) to confirm.
- Press the < > icons (B7) and (B8) to set the time after which the appliance will go off

(after 1/2 hour, 1 hour, 2 hours).

- Press the OK icon (B9) to confirm.
- Press the ← icon (B6) to exit.

Setting the clock



- Press the SET icon (B2) to enter the menu and then the < > icons (B7) and (B8) until "SET CLOCK" is displayed.
- Press the OK icon (B9).
- Use the < > icons (B7) and (B8) to set the hour, then press the OK icon (B9) to confirm.
- Use the < > icons (B7) and (B8) to set the minutes, then press the OK icon (B9) to confirm.
- Press the ← icon (B6) to exit the menu.

Setting auto-start time

This function programmes the time the machine will come on automatically.

- Make sure the clock on the appliance has been set.
- Press the SET icon (B2) to enter the menu and then the < > icons (B7) and (B8) until "START TIME" is displayed.
- Press the OK icon (B9).
- Use the < > icons (B7) and (B8) to set the auto-start time, then press the OK icon (B9) to confirm.
- Use the < > icons (B7) and (B8) to set the minutes, then press the OK icon (B9) to confirm.

Auto-start

- Press the < > icons (B7) and (B8) to activate the auto-start function until "AUTO START" is displayed.
- Press the OK icon (B9) to confirm. The  symbol appears on the display.
- Press the ← icon (B6) to exit the menu.
- To deactivate the automatic start-up function, press the SET (B2) icon, then press the < > (B7) and (B8) icons until the appliance displays the message AUTO START. Press the OK (B9) icon. CONFIRM will appear on the display. Press ← to deactivate and the  symbol

will disappear.

Changing coffee temperature

To change coffee temperature, proceed as follows:

- Press the SET icon (B2) to enter the menu and then the < > icons (B7) and (B8) until "TEMPERATURE" is displayed.
- Press the OK icon (B9).
- Press the < > icons (B7) and (B8) to select the required coffee temperature from low, medium and high.
- Press the OK button (B9) to confirm the temperature selected.
- Press the ← icon (B6) to exit the menu.

Setting water hardness

The operating period can be extended if required, making descaling less frequent by programming the machine on the basis of the real lime content in the water used.

Proceed as follows:

- Remove the "Total Hardness Test" strip (attached to page 2) from its packaging then dip it fully in the water for a few seconds, Then remove and wait about 30 seconds (until it changes colour and forms red squares).
- Turn the appliance on by pressing the On-Off/stand-by button (A7).
- Press the SET icon (B2) to enter the menu and then the < > icons (B7) and (B8) until "WATER HARDNESS" is displayed.
- Press the OK icon (B9).
- Press the < > icons (B7) and (B8) until the number coincides with the number of red squares on the test strip (for example, if there are 3 red squares on the test strip, select the message "WATER HARDNESS 3").
- Press the OK icon (B9) to confirm. The coffee maker is now programmed to provide the descale warning when actually necessary.

Programming coffee

For instructions on programming coffee, see the

"CHANGING THE QUANTITY OF COFFEE IN THE CUP" section.

Programming cappuccino

For instructions on programming cappuccino, see the "CHANGING THE QUANTITY OF MILK AND COFFEE FOR CAPPUCCINO" section.

Programming water

For instructions, see the "CHANGING THE QUANTITY OF HOT WATER" section.

Descaling



Important! Descaler contains acids. Respect the safety warnings provided by the manufacturer and given on the descaler pack.



N.B.! Use the descaler recommended by the manufacturer only. Use of other descalers invalidates the guarantee. Failure to descale the appliance as described also invalidates the guarantee.



Important! Before descaling, make sure the water softener filter has been removed.

When "PLEASE DESCALE !" is displayed, the machine requires descaling.

Proceed as follows:

- Make sure the machine is ready;
- Attach the hot water spout (C7) to the nozzle (A10).
- Press the SET icon (B2) to enter the menu and then the < > icons (B7) and (B8) until "DESCALE" is displayed.
- Press the OK icon (B9) and the appliance displays "DESCALE PLEASE CONFIRM".
- Press the OK icon (B9). The message "ADD DESCALER PLEASE CONFIRM" is displayed.
- Empty the tank of water, pour the contents of the descaler bottle into the tank respecting the instructions given on the descaler pack, then add water up to the MAX level marked on the water tank.
Position a container with a capacity of about

2 litres under the hot water spout.

- Press the OK icon (B9). Descaler flows out of the hot water spout into the container below.
The appliance displays: "DESCALING".
- The descale programme automatically performs a series of deliveries and pauses.
- After about 30 minutes "DESCALE COMPLETE PLEASE CONFIRM" is displayed.
- Press the OK icon (B9). "RINSING PLEASE CONFIRM" is displayed.
- Empty the water tank, rinse to eliminate descaler residues, then fill with clean water.
- Replace the tank full of clean water. "RINSING PLEASE CONFIRM" is displayed again.
- Press the OK icon (B9) again. Hot water flows out of the spout into the container below and "RINSING" is displayed.
- Wait until "RINSING COMPLETE PLEASE CONFIRM" is displayed.
- Press the OK icon (B9). "DESCALE COMPLETE" is displayed, then "FILL TANK". Fill the tank again with clean water.
- The descale programme is now terminated and the appliance is ready to make coffee again.

NOTE: If descaling is interrupted before completion, the process must be begun again from the beginning.



Important! FAILURE TO DESCALE THE APPLIANCE REGULARLY INVALIDATES THE GUARANTEE.

Resetting default values (reset)

If you change the original values, the default values can be reset as follows:

- Press the SET icon (B2) to enter the menu and then the < > icons (B7) and (B8) until "RESET TO DEFAULT" is displayed.
- Press the OK icon (B9) and the appliance displays "RESET TO DEFAULT PLEASE CONFIRM".
- Press the OK icon (B9) to reset the default values.

Statistics

This displays statistics relating to the machine.

To display, proceed as follows:

- Press the SET icon (B2) to enter the menu and then the < > icons (B7) and (B8) until "STATISTICS" is displayed.
- Press the OK icon (B9).
- Press the < > icons (B7) and (B8) to verify:
 - How many coffees and cappuccinos have been made.
 - How many times the machine has been descaled.
 - The total number of litres of water delivered.
- Press the ← icon (B6) once to exit the function or twice to exit the menu.

Buzzer

This activates or deactivates the buzzer emitted by the machine each time an icon is pressed or an accessory is inserted/removed.



N.B.! The buzzer is active by default.

- Press the SET icon (B2) to enter the menu and then the < > icons (B7) and (B8) until "BUZZER" is displayed.
- Press the OK icon (B9). "BUZZER PLEASE CONFIRM" is displayed.
- Press the ← icon (B6) to disable or the OK icon (B9) to enable the buzzer.
- Press the ← icon (B6) to exit the menu.

Adjusting contrast

To increase or reduce the contrast of the display, proceed as follows:

- Press the SET icon (B2) to enter the menu and then the < > icons (B7) and (B8) until "CONTRAST" is displayed.
- Press the OK icon (B9).
- Press the < > icons (B7) and (B8) until the required display contrast is reached. The progressive bar indicates the level of contrast selected.
- Press the OK icon (B9) to confirm.
- Press the ← icon (B6) once to exit the function

or twice to exit the menu.

Water filter

For instructions on the water softener filter, see the section "INSTALLING THE FILTER".

TURNING THE APPLIANCE OFF

Each time the appliance is turned off, it performs an automatic rinse cycle which cannot be interrupted.



Danger of burns! During rinsing, a little hot water flows from the coffee spouts.

Avoid contact with splashes of water.

To turn the appliance off, press the On-Off/stand-by button (A7).

The appliance performs the rinse cycle then goes off.



N.B.! If the appliance is not used for an extended period, place the main switch (A23) on the back of the appliance in the 0 position.

TECHNICAL SPECIFICATION

Voltage: 220-240 V~ 50/60 Hz max. 10A

Absorbed power: 1350 W

Pressure: 15 bars

Water tank capacity: 1.8 litres

Size LxHxD: 595x456x412 mm

Weight: 26 kg



The appliance complies with the following EC directives:

- Low Voltage Directive 2006/95/EC and subsequent amendments;
- EMC Directive 2004/108/EC and subsequent amendments
- EC Regulation 1275/2008 for standby

Materials and accessories coming into contact with food conform to European regulation (EC) no. 1935/2004.

ELECTRICAL CONNECTION (UK ONLY)

- A) If your appliance comes fitted with a plug, it will incorporate a 13 Amp fuse. If it does not fit your socket, the plug should be cut off from the mains lead, and an appropriate plug fitted, as below.

WARNING: Very carefully dispose of the cut off plug after removing the fuse: do not insert in a 13 Amp socket elsewhere in the house as this could cause a shock hazard.

With alternative plugs not incorporating a fuse, the circuit must be protected by a 15 Amp fuse. If the plug is a moulded-on type, the fuse cover must be re-fitted when changing the fuse using a 13 Amp Asta approved fuse to BS 1362. In the event of losing the fuse cover, the plug must NOT be used until a replacement fuse cover can be obtained from your nearest electrical dealer. The colour of the correct replacement fuse cover is that as marked on the base of the plug.

- B) If your appliance is not fitted with a plug, please follow the instructions provided below:

WARNING - THIS APPLIANCE MUST BE EARTHED

IMPORTANT

The wires in the mains lead are coloured in accordance with the following code:

Green and yellow:	Earth
Blue:	Neutral
Brown:	Live



As the colours of the wires in the mains lead may not correspond with the coloured markings identifying the terminals in your plug, proceed as follows:

The green and yellow wire must be connected to the terminal in the plug marked with the letter E or the earth symbol \perp or coloured green or green and yellow.

The blue wire must be connected to the terminal marked with the letter N or coloured black.

The brown wire must be connected to the terminal marked with the letter L or coloured red.

DISPLAYED MESSAGES

DISPLAYED MESSAGE	POSSIBLE CAUSE	REMEDY
FILL TANK	<ul style="list-style-type: none"> The water tank is empty or positioned incorrectly. 	<ul style="list-style-type: none"> Fill the tank with water and/or insert it correctly, pushing it as far as it will go.
GROUND TOO FINE ADJUST MILL AND <i>(alternating with)</i> PRESS OK	<ul style="list-style-type: none"> The grinding is too fine and the coffee is delivered too slowly. The machine cannot make coffee as there is air in the hydraulic circuit Possible cause: the filter has not been installed correctly. 	<ul style="list-style-type: none"> Turn the grinding adjustment knob one click clockwise towards "7". Make sure the filter (A9) is properly installed and that the installation has been carried out correctly.
GROUND TOO FINE ADJUST MILL AND <i>(alternating with)</i> PRESS OK <i>(then)</i> FILL TANK!	<ul style="list-style-type: none"> The tank has been removed during delivery. There is air in the hydraulic circuit. 	<ul style="list-style-type: none"> Insert the tank and press the OK icon (B9). "HOT WATER PRESS OK" is displayed. Press the OK icon (B9) again. The appliance is once again ready for use.
EMPTY WASTE COFFEE CONTAINER	<ul style="list-style-type: none"> The waste coffee container (A4) is too full or more than 3 days have passed since you last made coffee (this guarantees correct hygiene of the machine). 	<ul style="list-style-type: none"> Empty the waste coffee container and clean, then replace. Important: when removing the drip tray, the waste coffee container MUST be emptied, even if it is not completely full. If this is not done, when you make the next coffees, the waste coffee container may fill up more than expected and clog the machine.
INSERT WASTE COFFEE CONTAINER	<ul style="list-style-type: none"> After cleaning, the waste coffee container has not been replaced. 	<ul style="list-style-type: none"> Open the service door and insert the waste coffee container.

DISPLAYED MESSAGE	POSSIBLE CAUSE	REMEDY
ADD PRE-GROUND COFFEE	<ul style="list-style-type: none"> The "pre-ground coffee" function has been selected without placing any pre-ground coffee in the funnel. The funnel (A21) is blocked. 	<ul style="list-style-type: none"> Extract the appliance and place pre-ground coffee in the funnel. Empty the funnel with the help of a knife as described in the section "Cleaning the pre-ground coffee funnel".
PLEASE DESCALE! <i>(alternating with)</i> MEDIUM CUP NORMAL TASTE	<ul style="list-style-type: none"> The machine must be descaled. 	<ul style="list-style-type: none"> The descaling procedure described in the "Descaling" section needs to be performed as soon as possible.
LESS COFFEE	<ul style="list-style-type: none"> Too much coffee has been used. 	<ul style="list-style-type: none"> Select a milder taste or reduce the quantity of pre-ground coffee, then make the coffee again.
FILL BEAN CONTAINER	<ul style="list-style-type: none"> The coffee beans have run out. 	<ul style="list-style-type: none"> Fill bean container
INSERT BREWING UNIT	<ul style="list-style-type: none"> The brewing unit has not been replaced after cleaning. 	<ul style="list-style-type: none"> Insert the brewing unit as described in the section "Cleaning the brewing unit".
CLOSE DOOR	<ul style="list-style-type: none"> The service door is open 	<ul style="list-style-type: none"> Close the service door.
GENERAL ALARM!	<ul style="list-style-type: none"> The inside of the appliance is very dirty. 	<ul style="list-style-type: none"> Clean the inside of the appliance thoroughly, as described in the section "Cleaning and maintenance". If the message is still displayed after cleaning, contact a customer services.
REPLACE FILTER!	<ul style="list-style-type: none"> The water softener filter (A9) must be replaced. 	<ul style="list-style-type: none"> You must immediately replace the filter following the instructions in the section "Replacing the filter".

TROUBLESHOOTING

Below is a list of some of the possible malfunctions.

If the problem cannot be resolved as described, contact Customer Services.

PROBLEM	POSSIBLE CAUSE	REMEDY
The coffee is not hot	<ul style="list-style-type: none"> • The cups were not pre-heated. • The brewing unit has cooled down because 2/3 minutes have elapsed since the last coffee was made. • The temperature set is too low. 	<ul style="list-style-type: none"> • Warm the cups by rinsing them with hot water. • Before making coffee, preheat the brewing unit by pressing the ☺ icon (B3). • Change the set temperature (see paragraph "Changing coffee temperature").
The coffee is not creamy enough	<ul style="list-style-type: none"> • The coffee is ground too coarsely. • Wrong type of coffee 	<ul style="list-style-type: none"> • Turn the grinding adjustment knob one click anticlockwise towards "1" while the coffee mill is in operation (fig. 14). • Use a type of coffee for espresso coffee makers.
The coffee is delivered too slowly or a drop at a time.	<ul style="list-style-type: none"> • The coffee is ground too finely. 	<ul style="list-style-type: none"> • Turn the grinding adjustment knob one click clockwise towards "7" while the coffee mill is in operation (fig. 14). Continue one click at a time until coffee delivery is satisfactory. The effect is only visible after delivering two coffees.

PROBLEM	POSSIBLE CAUSE	REMEDY
The coffee is delivered too quickly.	<ul style="list-style-type: none"> The coffee is ground too coarsely. 	<ul style="list-style-type: none"> Turn the grinding adjustment knob one click anticlockwise towards "1" while the coffee mill is in operation (fig. 14). Avoid turning the grinding adjustment knob excessively otherwise when you select 2 cups, the coffee may be delivered a drop at a time. The effect is only visible after delivering two coffees.
Coffee does not come out of one of the spouts.	<ul style="list-style-type: none"> The spouts are blocked 	<ul style="list-style-type: none"> Clean the spouts with a toothpick (fig. 27).
The coffee does not come out of the spouts, but from around the service door (A2).	<ul style="list-style-type: none"> The holes in the spouts are clogged with dry coffee dust. The coffee guide (A3) inside the service door is blocked and cannot swing. 	<ul style="list-style-type: none"> If necessary, remove coffee deposits with a toothpick, sponge or stiff bristled kitchen brush (fig. 27-29). Thoroughly clean the coffee guide (A3), particularly near the hinges.
Water comes out of the spouts instead of coffee	<ul style="list-style-type: none"> The pre-ground coffee may be blocked in the funnel (A21). 	<ul style="list-style-type: none"> Clean the funnel (A21) with a wooden or plastic fork, clean the inside of the machine.

PROBLEM	POSSIBLE CAUSE	REMEDY
Water comes out of the spouts instead of coffee.	<ul style="list-style-type: none"> The pre-ground coffee may be blocked in the funnel (A21). 	<ul style="list-style-type: none"> Clean the funnel (A21) with a wooden or plastic fork, clean the inside of the appliance.
The milk does not come out of the milk spout (C5).	<ul style="list-style-type: none"> The intake tube is not inserted or is inserted incorrectly. 	<ul style="list-style-type: none"> Insert the intake tube (C4) in the rubber washer in the milk container lid (fig. 24).
The milk is not well frothed.	<ul style="list-style-type: none"> The milk container lid is dirty. The frothed milk regulator is not positioned correctly. 	<ul style="list-style-type: none"> Clean the milk container lid as described in the section "Cleaning the milk container". Adjust following the instructions in the section "Making cappuccino".
The milk contains bubbles or squirts out of the milk spout.	<ul style="list-style-type: none"> The milk is not cold enough or is not semi-skimmed. The frothed milk regulator is incorrectly adjusted. The milk container lid is dirty. 	<ul style="list-style-type: none"> You should ideally use skimmed or semi-skimmed milk at refrigerator temperature (about 5°C). If the result is still disappointing, try another brand of milk. Move the frothed milk regulator slightly towards the word "CAFFELATTE" (see section "Making cappuccino"). Clean the milk container lid as described in the section "Cleaning the milk container".