

AQUAECO

WASHROOM AND PLUMBING SOLUTIONS

Installation Guide

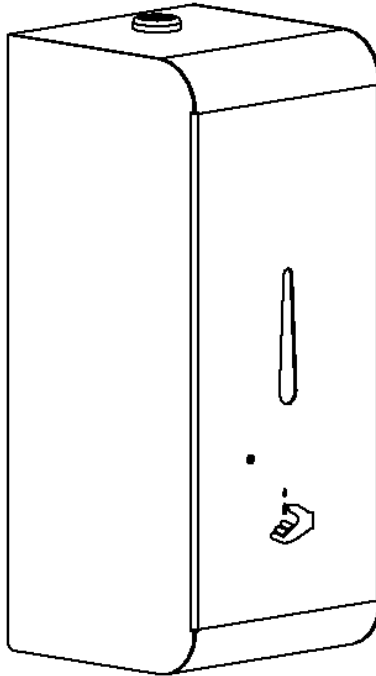

AQA-IX3-701-XX

IX304 WALL MOUNTED TOUCHLESS SOAP/SANITIZER DISPENSER

A member of SANIPEXGROUP
www.sanipexgroup.com

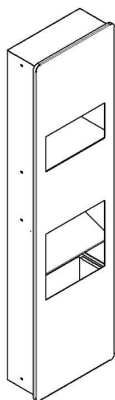
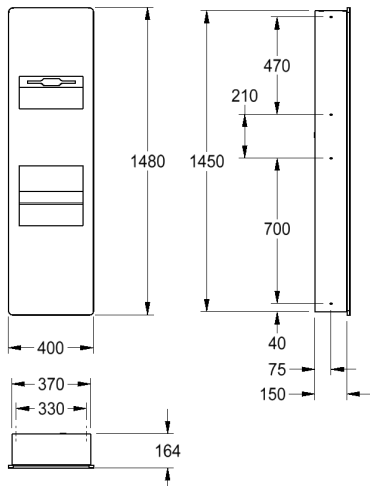

1x

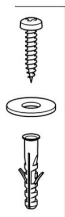

8x

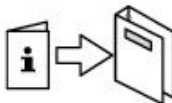

Installation and operating instructions

- Identify the required mounting height by coordinating with site engineer to ensure ample clearance for the other construction features that might obstruct, e.g. pipes, vents, conduits.
- Takeout the product from packaging and do initial inspection prior to the installation.
- Locate the AC connection point and prepare the wall cutout based one the recessed area (Refer Image 1).
- Secure the product base in the wall using mounting screws and dowels. For mounting, front panel should be removed from the body prior to the installation.
- Ensure the electrical connections are made correctly and reattach the front panel using the screws provided.
- For the Paper Towel Dispenser, multifold paper towel with the size of 230mm to 250mm length and 80mm to 105mm width.
- The waste bin has 25L volume waste capacity, it is recommended to use a plastic waste bag and secure it to the integrated bag holder.
- The front panel is secured with a magnetic catcher.

Hand drier specifications

Operating voltage 220-240V AC, 50-60 Hz

Total power 800-1000W

Heater 500W

Motor 500W

Air volume 80 m³/h

Air velocity 95 - 115 m/s

Warning

- Do not dispose of electrical appliances as unsorted municipal waste, use separate collection facilities.
- Contact your local government for information regarding the collection systems available. If electrical appliances are disposed of in landfills or dumps, hazardous substances can leak into the groundwater and get into the food chain, damaging your health and well-being. When replacing old appliances with new ones, the retailer is legally obligated to take back your old appliance for disposals at least free of charge.
- Include the device in the list of electrical equipment destined for periodic checking.
- To prevent the device from overheating or losing flow power, regularly clean it taking into account the level of usage and the amount of contamination in its operating environment.
- Before opening the device, disconnect it from the mains supply

ABRASIVE
S

AQUAECO

WASHROOM AND PLUMBING SOLUTIONS

A member of SANIPEXGROUP
www.sanipexgroup.com