

BAGNODESIGN

EXPERTLY CRAFTED BATHROOMS

Installation Guide

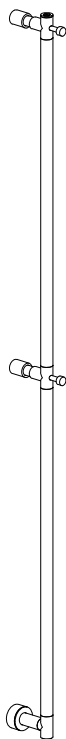

BDA-MLI-V002-XX

M-LINE VERTICAL HEATED TOWEL RAIL

A member of **SANIPEXGROUP**
www.sanipexgroup.com

IMPORTANT PLEASE READ

All products manufactured and supplied by BAGNODESIGN are fit for purpose as long as they are Installed, used correctly, cleaned and receive regular maintenance in accordance with these instructions...

Remove all packaging and check the product for damage or missing parts before commencing with the installation.

Any alterations made to this product and its components may infringe product certification, infringe water regulations and invalidate the guarantee. The Installation must comply with all local/national water supply authority regulations/bylaws and building and plumbing regulations, therefore we strongly recommend that your product be installed by a reputable qualified trade's person.

PRODUCT LIFECYCLE

"The product LiveCyclele is the collective stages that a product goes through from its conception and design through to its ultimate disposal."

DISPOSAL GUIDANCE

The best way to ensure your Product has a long life is to follow the Care and Maintenance guides set by the Manufacture after purchase. This document can be found at www.sanipexgroup.com. The life cycle of the product is not in correlation to the product Guarantee; the standards the products are manufactured or certified to (e.g. CE & WRAS) can exceed past the Guarantee duration. After the life cycle of the product is deemed complete by the end-user please follow the below to dispose of the items correctly...

CLEANING CARE GUIDE

Only use a mild soap and water for cleaning.
Rinse with water to remove the mild soap solution.
We recommend the product is dried using a soft cloth after every use.

Never use any abrasive or strong cleaning products containing, bleaches, acids (hydrochloric, formic, phosphorus, chlorine or acetic), strong detergents, limescale remover, alcohol or dyes etc.
Never use abrasive cleaning pads, wire wool or microfibre cloths.
Never use cleaning equipment that may have been pre-used and contaminated with the above substances.
Never apply the cleaning product directly onto the finished surface.

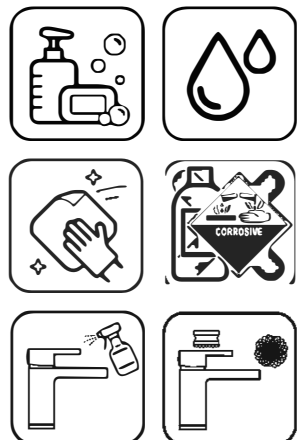

The following manual has been elaborated in order to supply all the useful information for a correct installation together with the precautions to adopt both from installer and users. **Manufacturer declines every responsibility in case of different uses from these instructions.**

The heated towel rails is connected to the mains with a **z type** connection, and consequently it cannot be substituted in any case of damage. Such an action would make the item dangerous and free the producer from every responsibility.

ATTENTION :This item can be only used as holder for towels and similar garments.

This item, in normal use, cannot be loaded with more than **5 Kg.** weight.

Please, only use provided screws and dowels or replace them with other ones equivalent or greater in mechanical characteristics.

PROTECTION DEGREE: Squirts resistant **IPX4.**

PACKING CONTENTS :

(2) Confection screw with dowel for flanges

(3) Sliding cups

(1) Confection screw with dowel for flange per BOX

(1) Flange for switch BOX

(1) Screw for flange fixing BOX M6 X 6

(1) Instruction & Operation Manual

Raw material : Brass, Operation: Electrical

INSTALLATION:

Take out the heated towel rail and its components from the package.

To mount the heated towel rails, insert the sliding caps in the wall brackets to slide, then rotate the switch box and let it coincide with the mains output from the wall; Consequently to mark their position and make the holes in correspondence of the flanges.

Fix the two flanges and the flange for switch box bracket to the wall by the proper screws.

Fix the wall brackets and the wall holder at the opposite side of the wall switch box. Rotate the item and approach it to the wall to connect the electrical whirls coming out from the wall to the cables exiting from the switch box and then fix the other two wall brackets. Only after finishing this action, you can turn the power on and verify the heated towel rails works correctly.

Our Company refuses any responsibility in the case the assembly doesn't respect the above mentioned instruction.

WARNING:

Whether a leakage of antifreeze liquid occurs from our electrical towel heaters, take care not to permit any contact with eyes and skin and avoid inhalation or ingestion

Packing Contents:

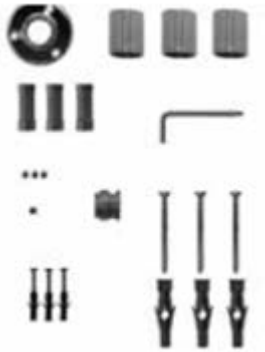

Technical drawing:

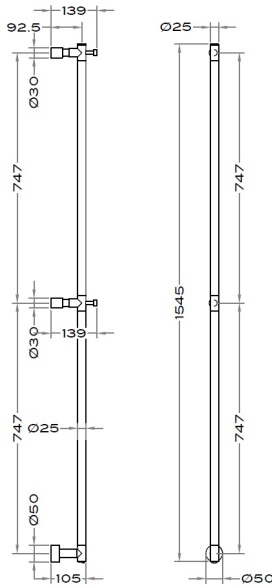

WARNING: DO NOT get rid of this item as urban waste, but swallow it separately or by properly equipped institutes.

IMPORTANT:

THE ELECTRICAL CONNECTION BETWEEN ITEM AND MAINS MUST BE EXECUTED BY QUALIFIED STAFF AND AFTER TURNING OFF ELECTRICITY AT THE MAIN PANEL.

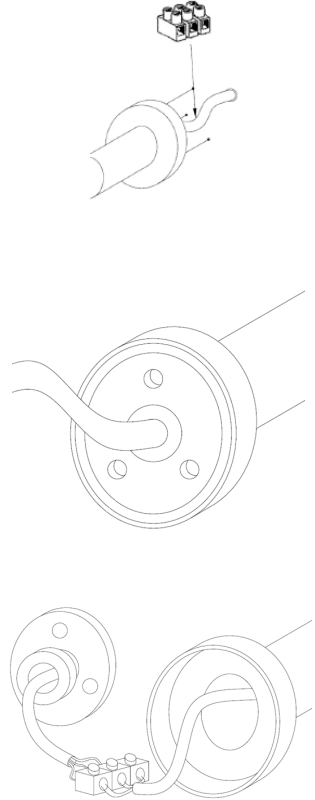
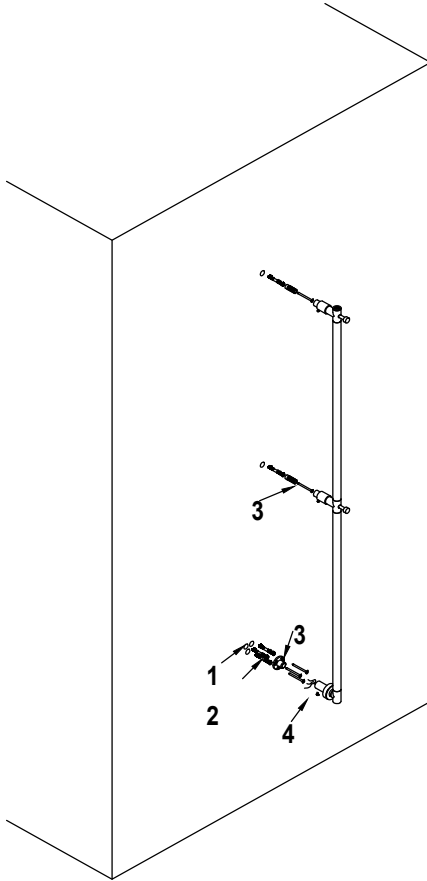

Instruction:

1. Mark the holes to the desired location and drill holes in wall.
2. Insert screw anchors in to the holes.
3. Fix all wall supports to the wall by using screw driver and locate the slide rail bracket to the wall supports.
4. Straighten the towel rail and tighten the screw.

RECOMMENDED INSTALLATION ZONES

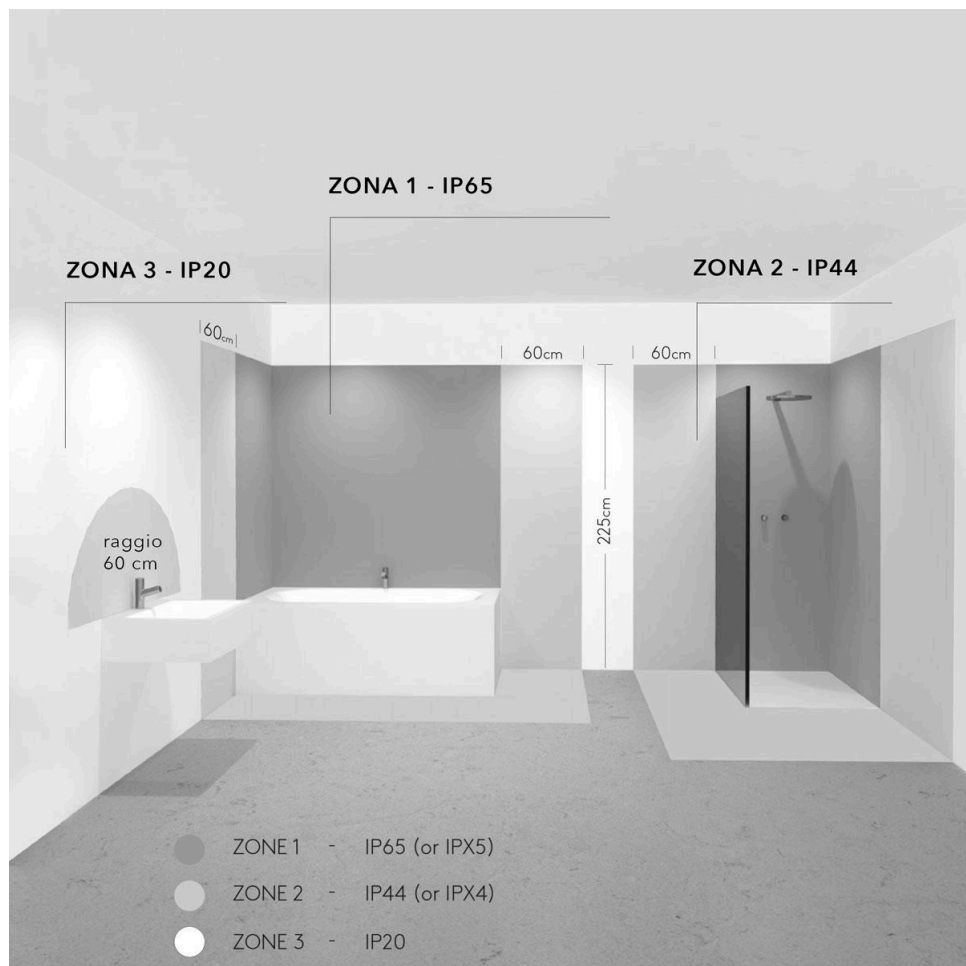

Sanipex Product Code	Product Description	Heating Type	Electrical
BDA-MLI-V002-XX	M-LINE VERTICAL HEATED TOWEL RAIL ANTHRACITE	Electric	30
BDA-MLI-V002-CP	M-LINE VERTICAL HEATED TOWEL RAIL CHROME	Electric	22.5

BAGNODESIGN

EXPERTLY CRAFTED BATHROOMS
