

BAGNODESIGN

M-LINE

BDD-MLI-514

WALL MOUNTED SHOWER COLUMN WITH 3 WAY DIVERTER

INSTALLATION AND MAINTENANCE GUIDE

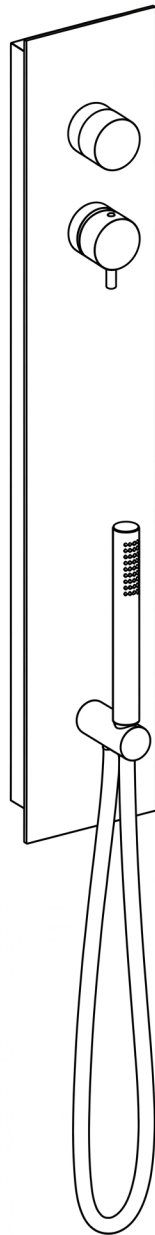

SANIPEXGROUP

COMPONENTS

COMPONENTS PROVIDED



x1 SHOWER COLUMN

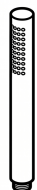

x1 HAND SHOWER



x1 1500MM PVC HOSE



x2 GASKET



x1 SCREW

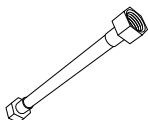

x2 FLEXIBLE HOSE

TOOLS REQUIRED



x1 ADJUSTABLE SPANNER

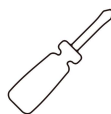

x1 SCREWDRIVER



x1 DRILL



x1 ALLEN KEY

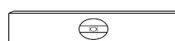

x1 SPIRIT LEVEL

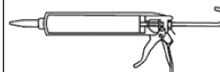

x1 SEALANT GUN

ATTENTION

IMPORTANT PLEASE READ

All products manufactured and supplied by BAGNODESIGN are fit for purpose as long as they are installed, used correctly, cleaned and receive regular maintenance in accordance with these instructions. Remove all packaging and check the product for damage or missing parts before commencing with the installation. Any alterations made to this product and its components may infringe product certification, infringe water regulations and invalidate the guarantee. The Installation must comply with all local/national water supply authority regulations/bylaws and building and plumbing regulations, therefore we strongly recommend that your product be installed by a reputable qualified trade's person.

DISPOSAL GUIDANCE

The best way to ensure your product has a long life is to follow the Care and Maintenance guides set by the Manufacture after purchase. This document can be found at www.sanipexgroup.com.

The life cycle of the product is *not* in correlation to the product Guarantee; the standards the products are manufactured or certified to (e.g. CE & WRAS) can exceed past the Guarantee duration.



By following our recommended cleaning and maintenance guidelines, you will preserve the quality and appearance of your product, ensuring reliable performance and long-lasting enjoyment for many years.

PRODUCT CLEANING

We recommend cleaning with a soft damp cloth and mild soap solution.

DO NOT use cream cleaners or cleaners containing bleach.

DO NOT scrub or scour.

DO NOT use abrasive cleaning agents.

DO NOT use solvent based cleaners.

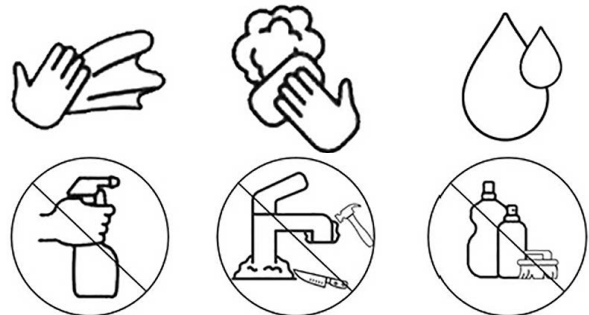

INLET WATER TEMPERATURES

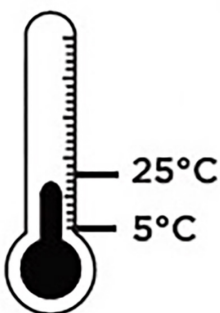

COLD WATER

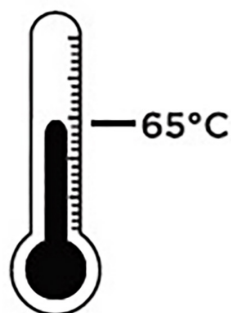

HOT WATER

**WARNING:
FLUSH THE
PIPES BEFORE
CONNECTING**



WATER PRESSURE



MIN 1.0 BAR



MAX 5.0 BAR

Hot and Cold pressure should be kept balanced within 1 BAR



RECOMMENDED 2.0 BAR - 3.0 BAR

INSTALLATION

PRODUCT DIMENSION

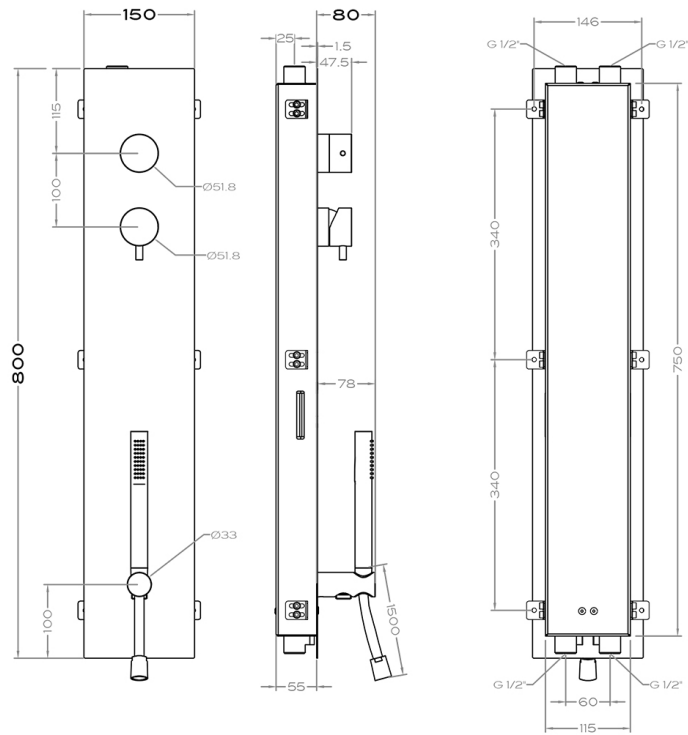

1

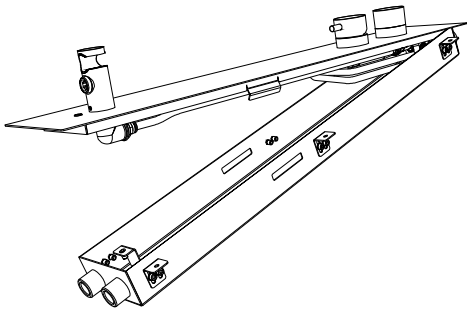
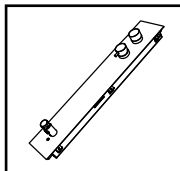

2

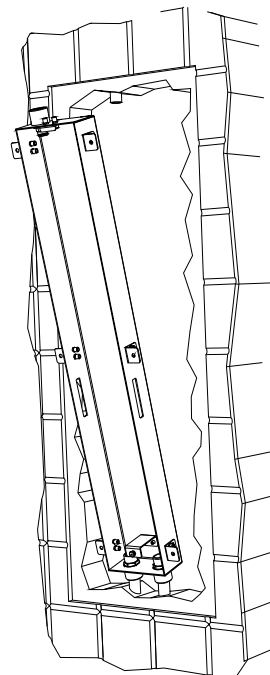
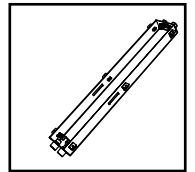

INSTALLATION

3

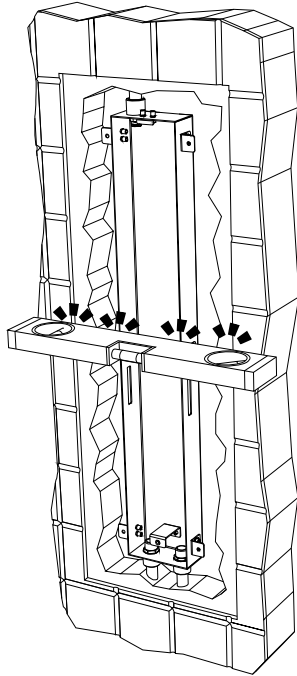

4

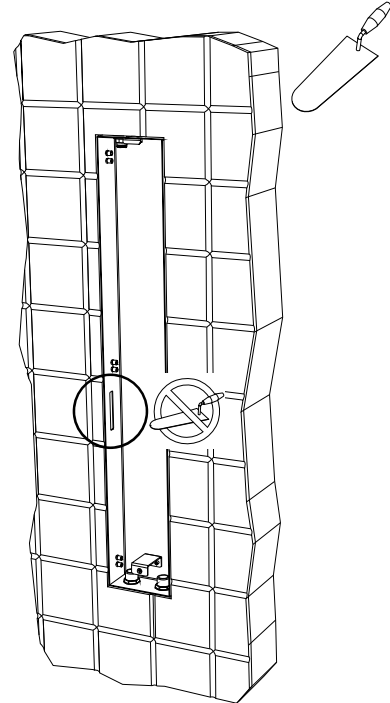

5

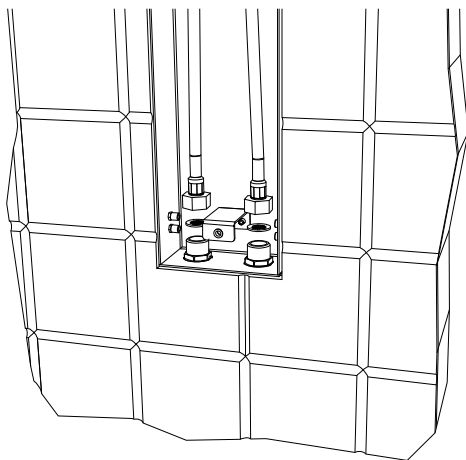

6

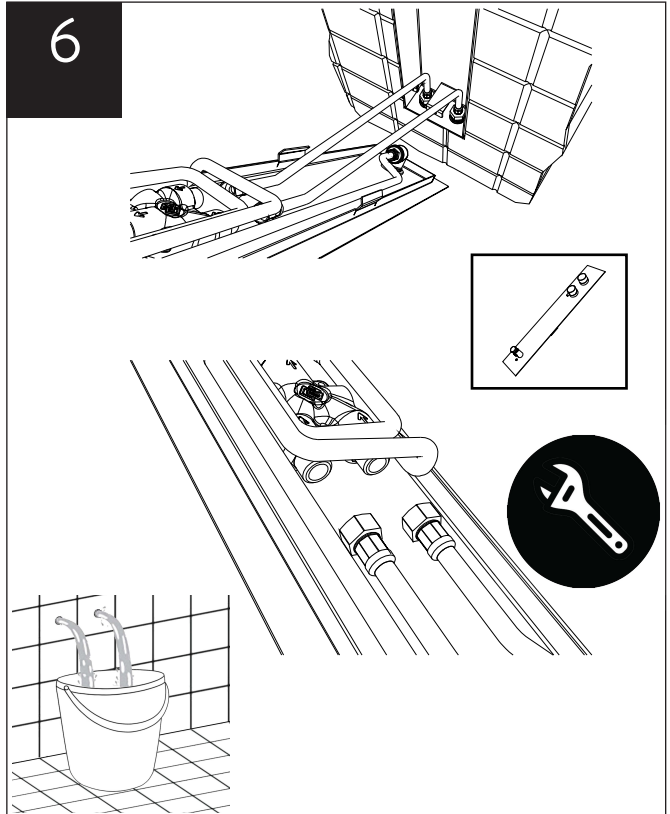

INSTALLATION

7

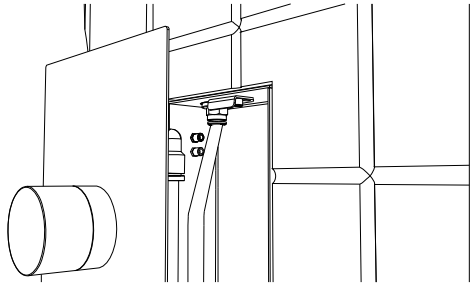

8

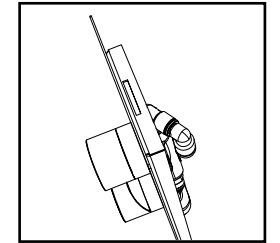
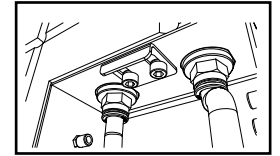
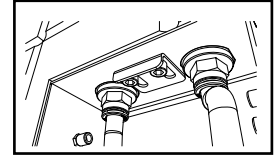
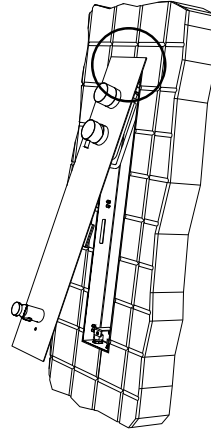

9

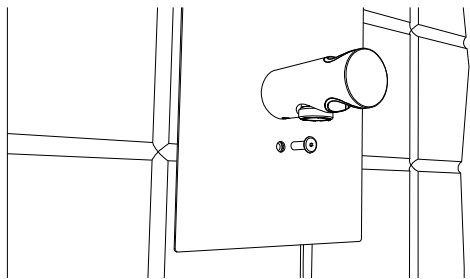
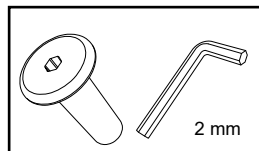

10

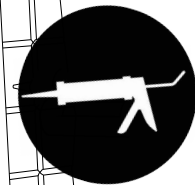
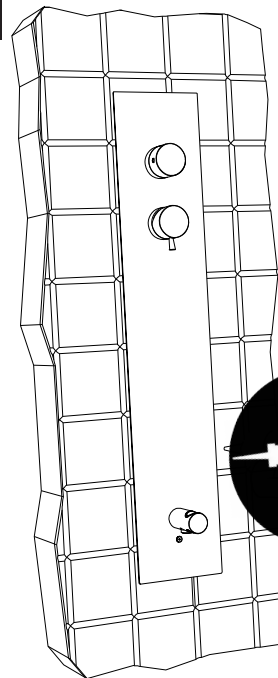

INSTALLATION

11

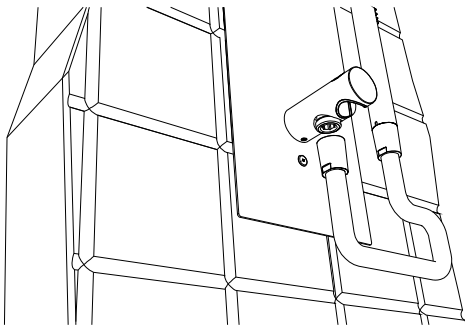
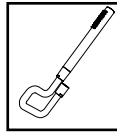

12

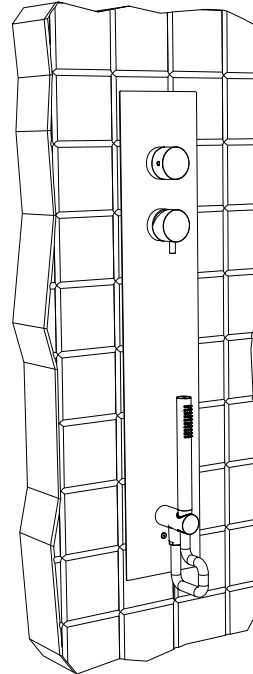

WARRANTY

Sanipex Group warrants that all Products will be free from manufacturing defects and design defaults on the date of purchase and for the duration mentioned in the Product Technical Specification sheet (“Warranty Period”).

Liability of Sanipex Group shall be limited to either repairing or replacing the faulty Products, at its sole discretion, if the same are within the Warranty Period. If Sanipex Group has ceased manufacturing the Product and is unable to replace the Product or provide a suitable part, Sanipex Group will offer to replace the Product with a suitable alternative product that matches the Product as closely as possible.

This warranty shall not be applicable on third party products and in such cases the warranty terms of the concerned third party shall apply.

For further details and information about our Warranty conditions and where certain exclusions may apply, please visit www.sanipexgroup.com/c/warranty

BAGNODESIGN

For more information visit www.bagnodesign.it



SANIPEXGROUP

This installation guide is for reference only. In case there is a discrepancy between that of the instructions and that of the actual product, the latter should be taken as standard. The rights of modification are reserved.