

# AQUAECO

## Deck Mounted Touchless Taps

AQE-ECO-I302M-A  
DECK MOUNTED TOUCHLESS TAP

---

### INSTALLATION AND MAINTENANCE GUIDE

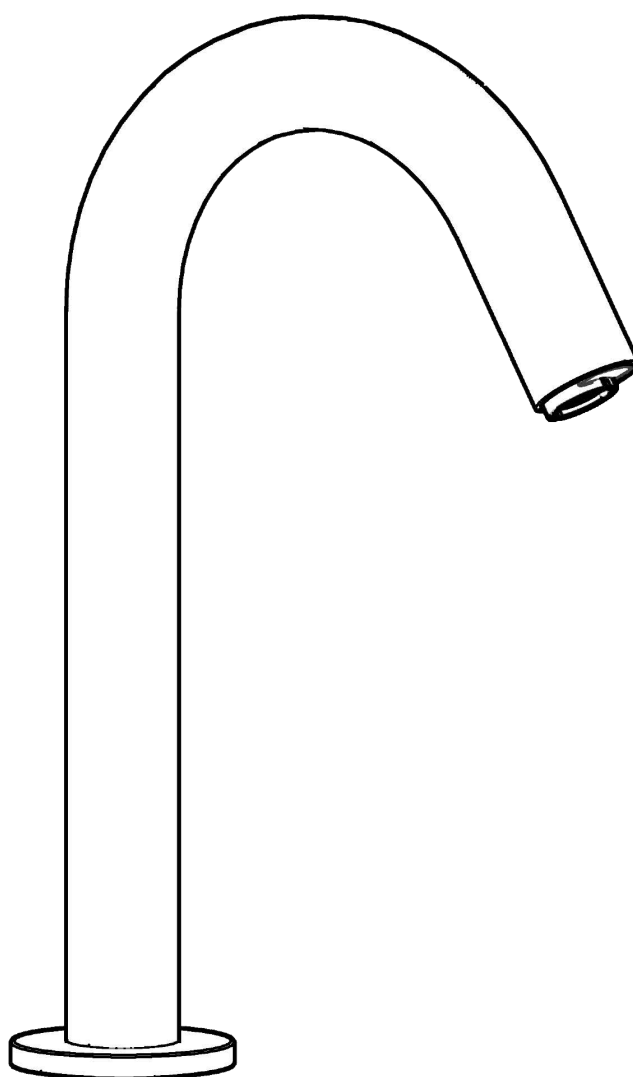

**SANIPEXGROUP**



# COMPONENTS

## COMPONENTS PROVIDED

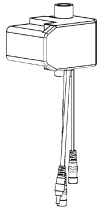

x1 BATTERY BOX

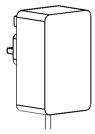

x1 AC ADAPTER

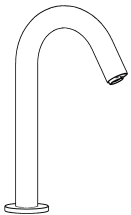

x1 SPOUT

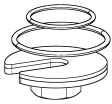

x1 FIXING KIT

## TOOLS REQUIRED

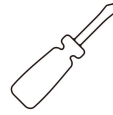

x1 SCREWDRIVER

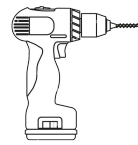

x1 DRILL



x1 ADJUSTABLE SPANNER

# ATTENTION

## IMPORTANT PLEASE READ

All products manufactured and supplied by BAGNODESIGN are fit for purpose as long as they are Installed, used correctly, cleaned and receive regular maintenance in accordance with these instructions.

Remove all packaging and check the product for damage or missing parts before commencing with the installation.

Any alterations made to this product and its components may infringe product certification, infringe water regulations and invalidate the guarantee. The Installation must comply with all local/national water supply authority regulations/bylaws and building and plumbing regulations, therefore we strongly recommend that your product be installed by a reputable qualified trade's person.

## DISPOSAL GUIDANCE

The best way to ensure your product has a long life is to follow the Care and Maintenance guides set by the Manufacture after purchase. This document can be found at [www.sanipexgroup.com](http://www.sanipexgroup.com).

The life cycle of the product is *not* in correlation to the product Guarantee; the standards the products are manufactured or certified to (e.g. CE & WRAS) can exceed past the Guarantee duration.

## INLET WATER TEMPERATURES

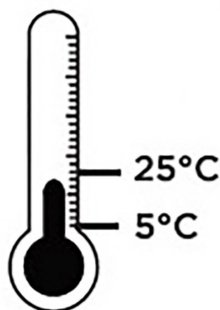

COLD WATER

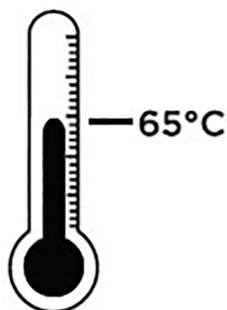

HOT WATER

For **MIXED** water use mixing valves

THERMOSTATIC

MECHANICAL

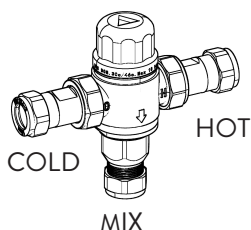

AQM-WRM-T301A-CON-CP

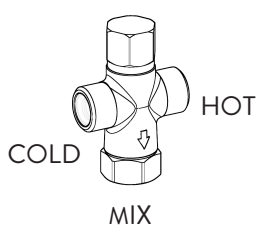

AQM-WRM-M301-CON-CP

## WATER PRESSURE



MIN 1.0 BAR



MAX 5.0 BAR

Hot and Cold pressure should be kept balanced within 1 BAR

# ATTENTION

## WARNING: FLUSH THE PIPES BEFORE CONNECTING



## CORRECT PIPE CONNECTIONS

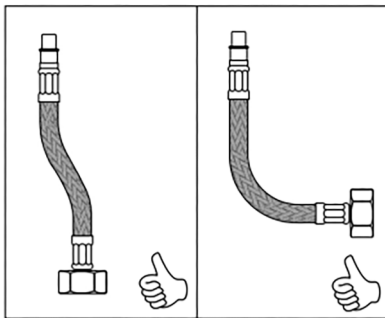

## INCORRECT PIPE CONNECTIONS

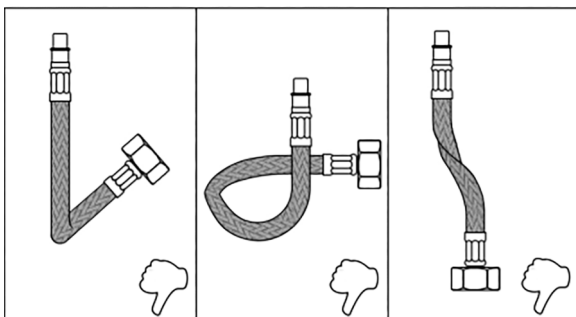

## PRODUCT CLEANING

We recommend cleaning with a soft damp cloth and mild soap solution.

**DO NOT** use cream cleaners or cleaners containing bleach.

**DO NOT** scrub or scour.

**DO NOT** use abrasive cleaning agents.

**DO NOT** use solvent based cleaners.



# SPECIFICATION

Power Supply	AC220V BACKUP (4x1.5V AA Batteries)
Power Consumption	<2W
Diameter of Water Supply	G1/2" (DN15)
Temperature	1°C~55°C
Detection zone	5-25 CM

## PRODUCT DIMENSION

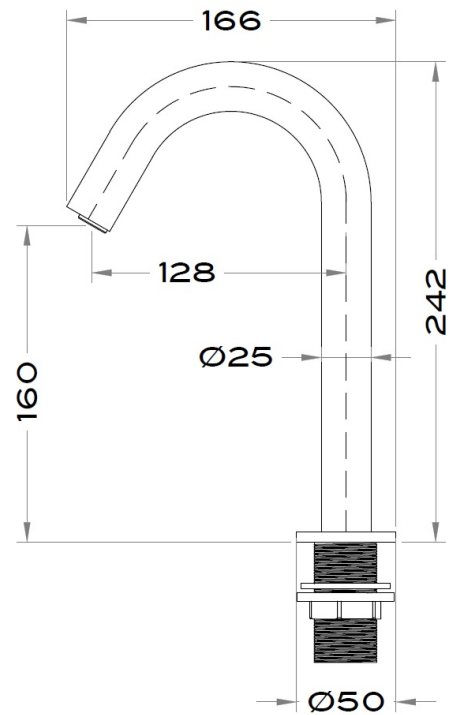

## RECOMMENDED DIMENSION

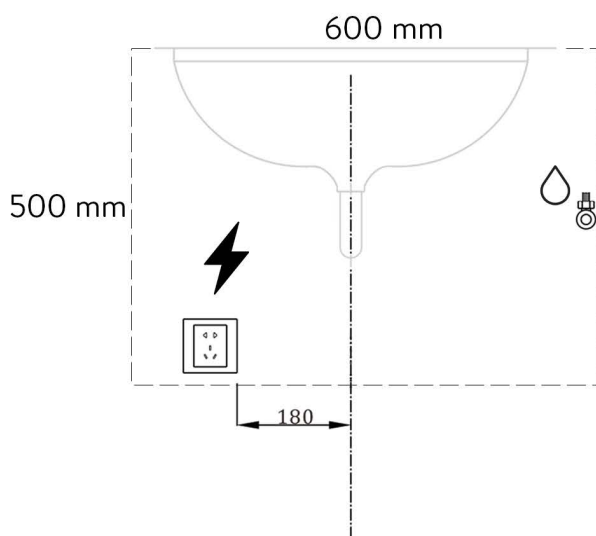

# INSTALLATION

1

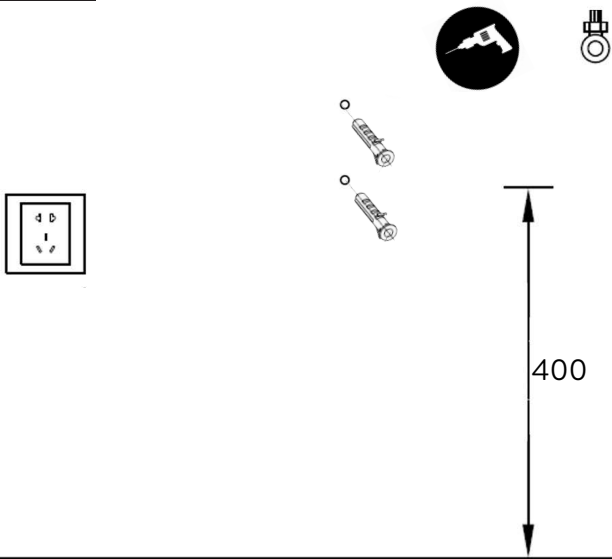

2

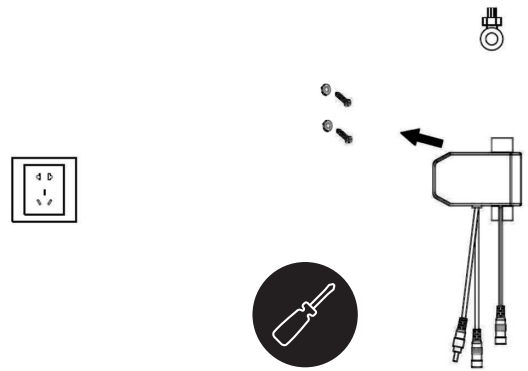

3

3.1

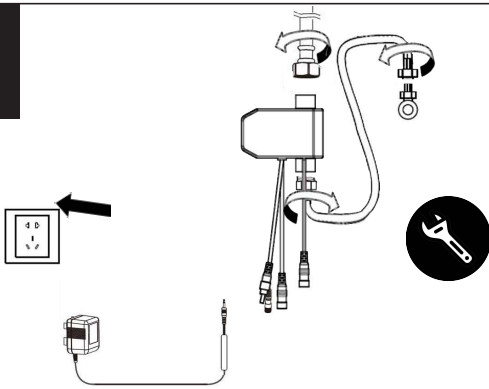

3.2

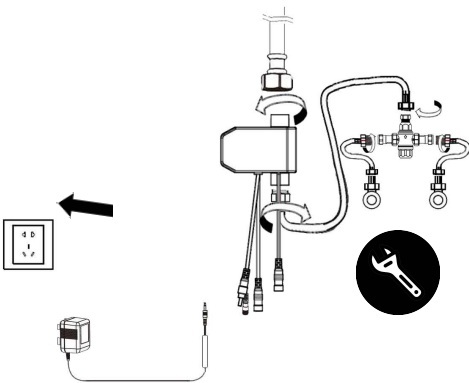

4

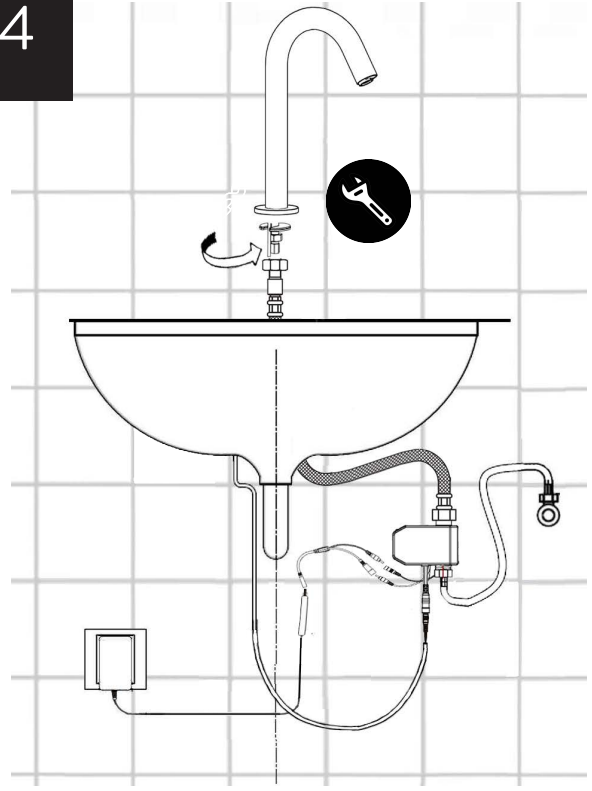

# INSTALLATION

5

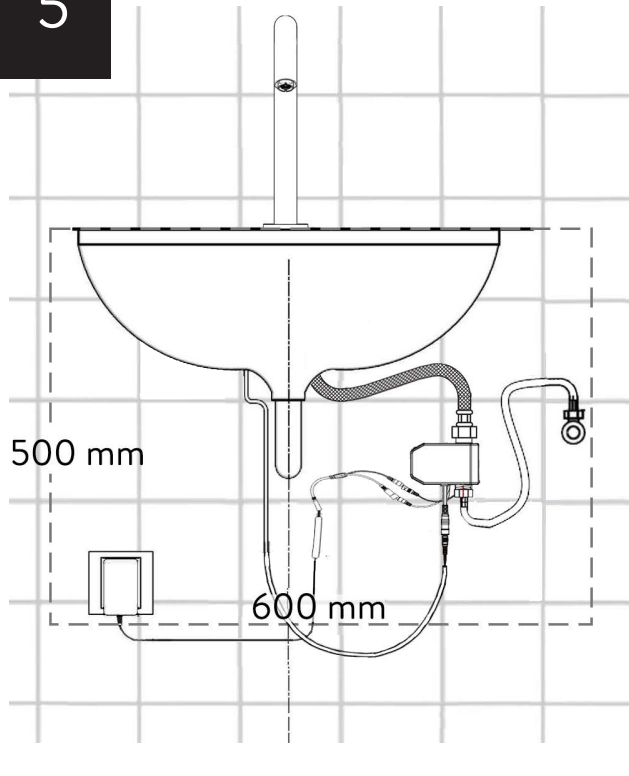



# MAINTENANCE

## CLEAN FILTER

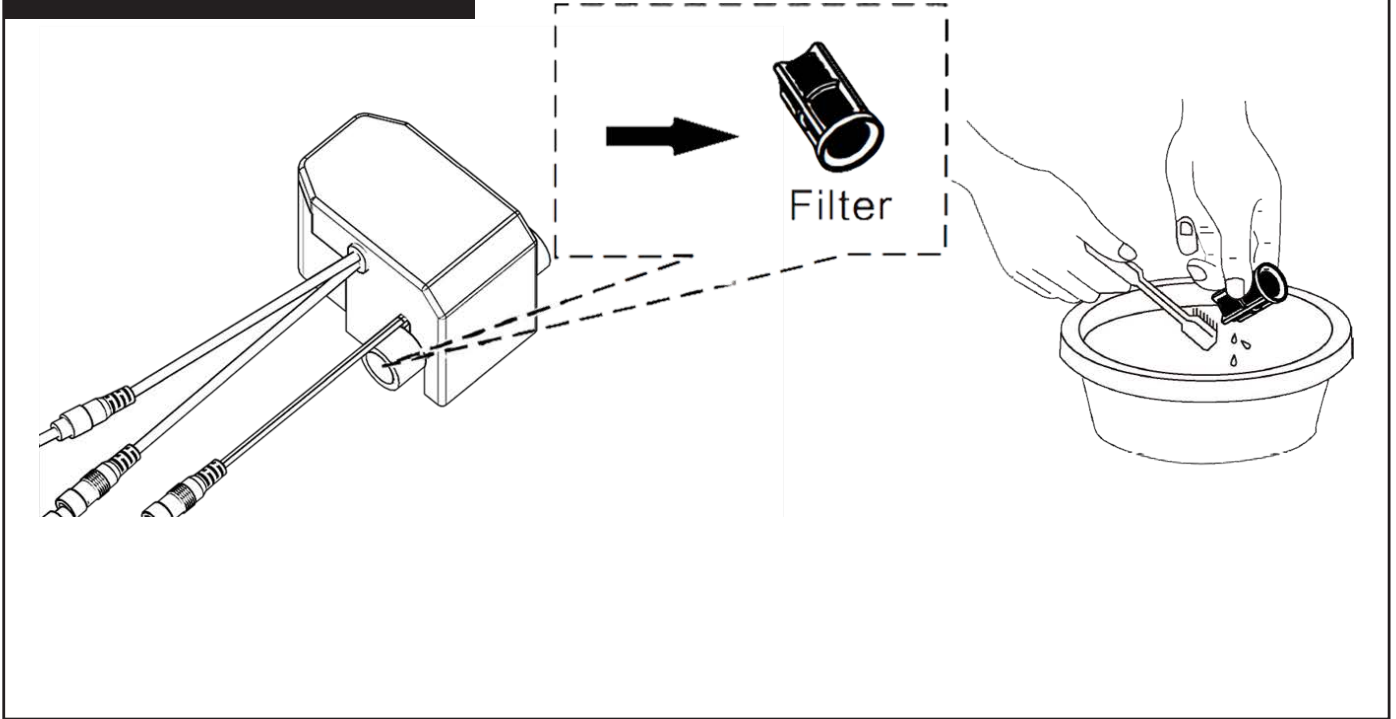

# TROUBLESHOOTING

Problem	Cause	Solution
No water	The battery is drained	Change the battery
	Water supply off	Check supply
	Dirt in the filter	Clean the filter
	Water pressure too low	Raise the pressure
Water will not turn off	Dirt on the sensor window	Clean the sensor
Too little water flow	Water supply is turned down	Adjust water supply
	The filter is too dirty	Clean the filter
	Water pressure is too low	Raise the pressure
Too much water flow	Water pressure is too high	Adjust pressure
Short cycles of battery	Incorrect batteries	Change to 4AA Alkaline batteries
The indicator light is not on	The light is broken	Change the light or circuit board
	The battery is drained	Change the battery
	Poor connection of battery	Change battery connections

# WARRANTY

Sanipex Group warrants that all Products will be free from manufacturing defects and design defaults on the date of purchase and for the duration mentioned in the Product Technical Specification sheet (“Warranty Period”).

Liability of Sanipex Group shall be limited to either repairing or replacing the faulty Products, at its sole discretion, if the same are within the Warranty Period. If Sanipex Group has ceased manufacturing the Product and is unable to replace the Product or provide a suitable part, Sanipex Group will offer to replace the Product with a suitable alternative product that matches the Product as closely as possible.

This warranty shall not be applicable on third party products and in such cases the warranty terms of the concerned third party shall apply.

For further details and information about our Warranty conditions and where certain exclusions may apply, please visit [www.sanipexgroup.com/c/warranty](http://www.sanipexgroup.com/c/warranty)

# AQUAECO

For more information visit [www.bagnodesign.it](http://www.bagnodesign.it)



SANIPEXGROUP

