

# BAGNODESIGN

EXPERTLY CRAFTED BATHROOMS

---

## Installation Guide

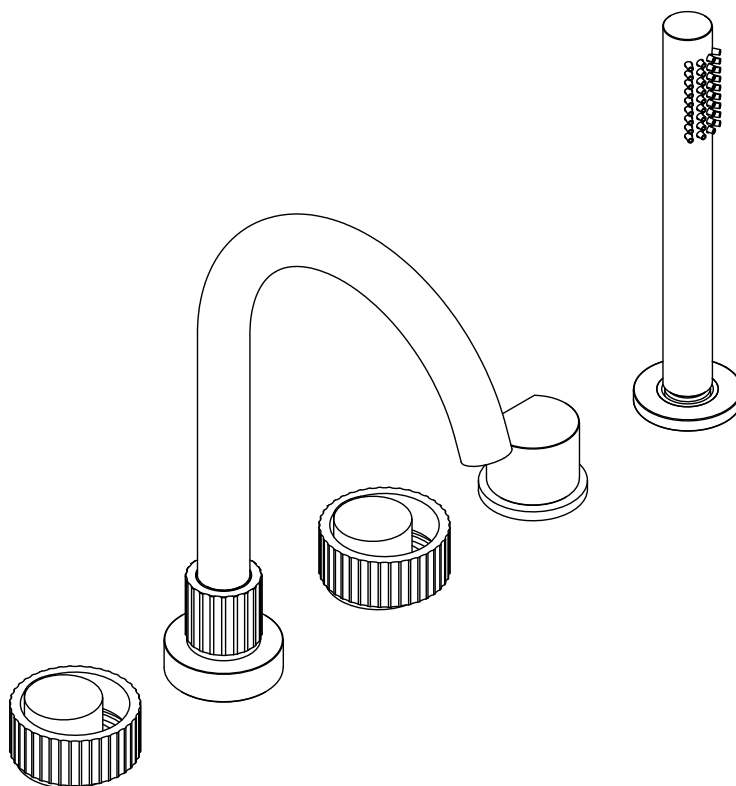

**BDM-ORO-453-XX**

OROLOGY 5 HOLE BATH/SHOWER MIXER WITHOUT HAND SHOWER

A member of **SANIPEXGROUP**  
[www.sanipexgroup.com](http://www.sanipexgroup.com)



## IMPORTANT PLEASE READ

All products manufactured and supplied by BAGNODESIGN are fit for purpose as long as they are Installed, used correctly, cleaned and receive regular maintenance in accordance with these instructions...

Remove all packaging and check the product for damage or missing parts before commencing with the installation.

Any alterations made to this product and its components may infringe product certification, infringe water regulations and invalidate the guarantee. The Installation must comply with all local/national water supply authority regulations/bylaws and building and plumbing regulations, therefore we strongly recommend that your product be installed by a reputable qualified trade's person.

## PRODUCT LIFECYCLE

*"The product LiveCyclele is the collective stages that a product goes through from its conception and design through to its ultimate disposal."*

## DISPOSAL GUIDANCE

The best way to ensure your Product has a long life is to follow the Care and Maintenance guides set by the Manufacture after purchase. This document can be found at [www.sanipexgroup.com](http://www.sanipexgroup.com).

The life cycle of the product is not in correlation to the product Guarantee; the standards the products are manufactured or certified to (e.g. CE & WRAS) can exceed past the Guarantee duration. After the life cycle of the product is deemed complete by the end-user please follow the below to dispose of the items correctly...

### Mixers (Taps):

If the mixers are no longer accepted due to mechanical use or aesthetic style, these can be disposed of at a registered Local Authority waste recycling center where the individual components can be sorted.

## CLEANING CARE GUIDE

Only use a mild soap and water for cleaning.  
Rinse with water to remove the mild soap solution.  
We recommend the product is dried using a soft cloth after every use.

**Never** use any abrasive or strong cleaning products containing, bleaches, acids (hydrochloric, formic, phosphorus, chlorine or acetic), strong detergents, limescale remover, alcohol or dyes etc.

**Never** use abrasive cleaning pads, wire wool or microfibre cloths.

**Never** use cleaning equipment that may have been pre-used and contaminated with the above substances.

**Never** apply the cleaning product directly onto the finished surface.

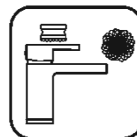

Not included



IT | Istruzioni Di Montaggio  
GB | Mounting Instructions  
FR | Instructions de montage  
DE | Montageanweisungen  
ES | Instrucciones de montaje



Min 0,5  
Max 5



Max 70°

1

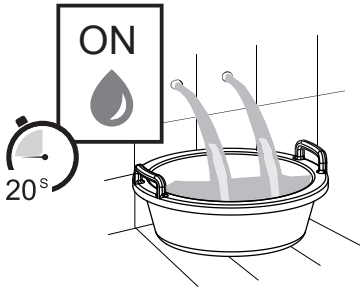

2

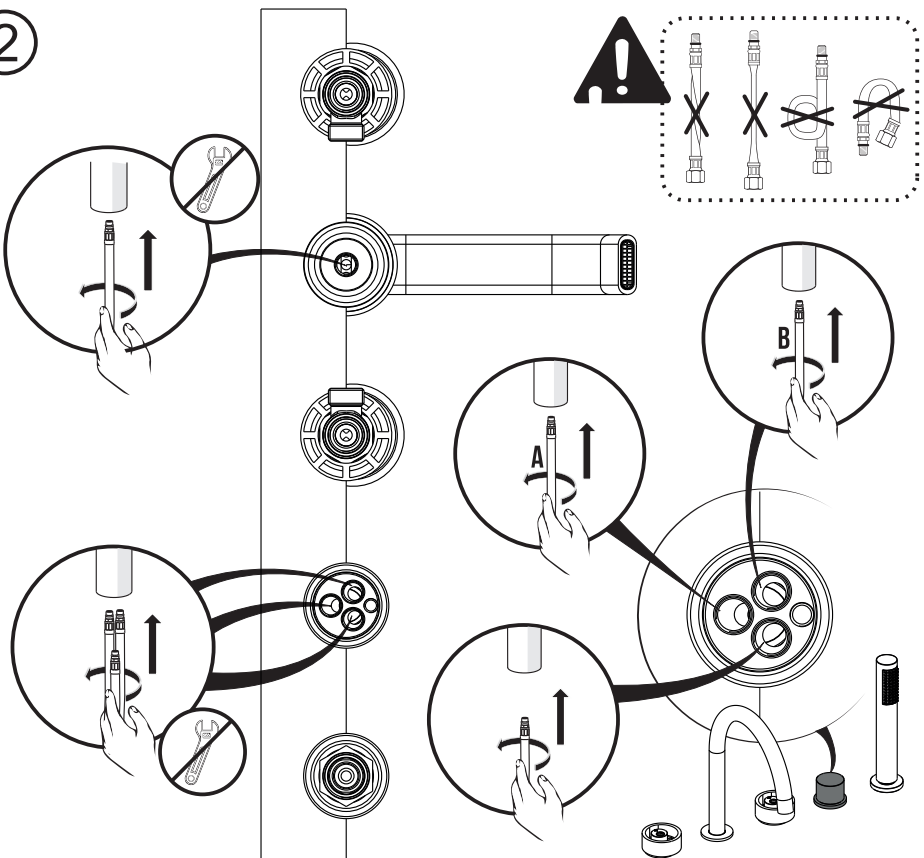

3

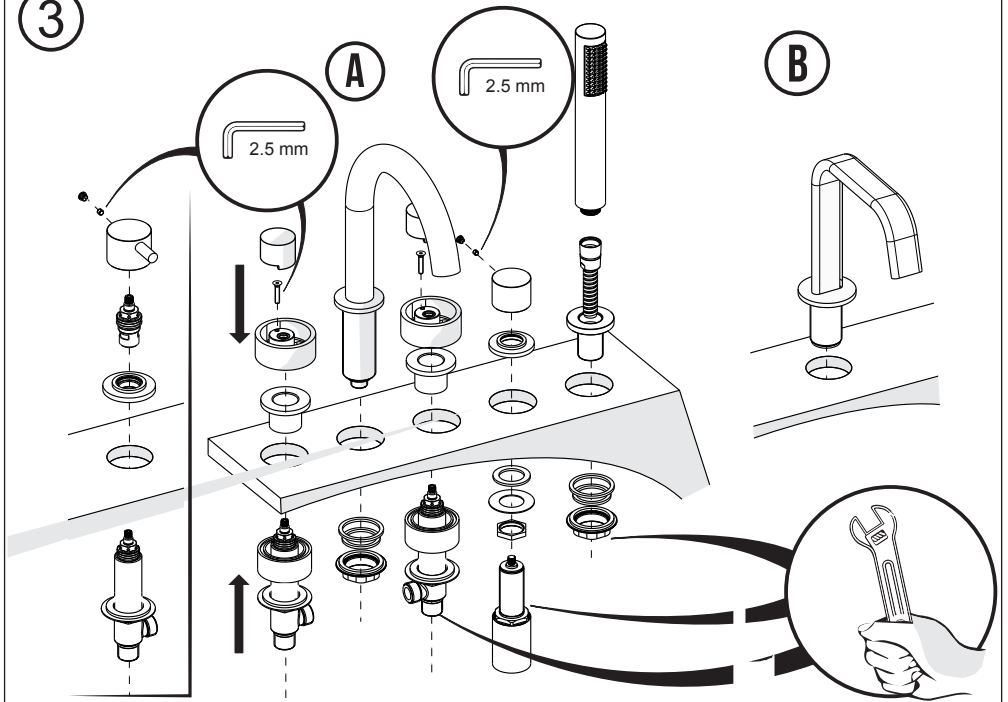

4  
A

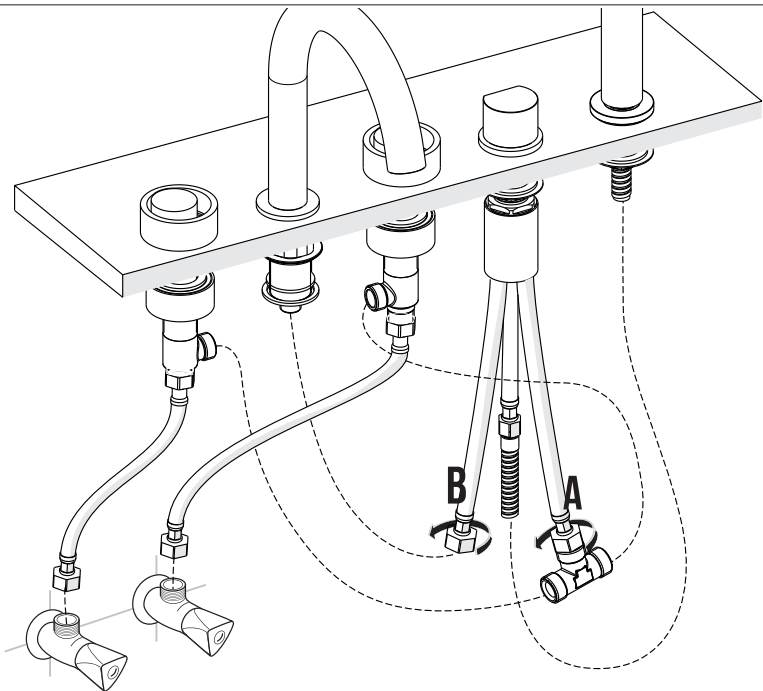

4

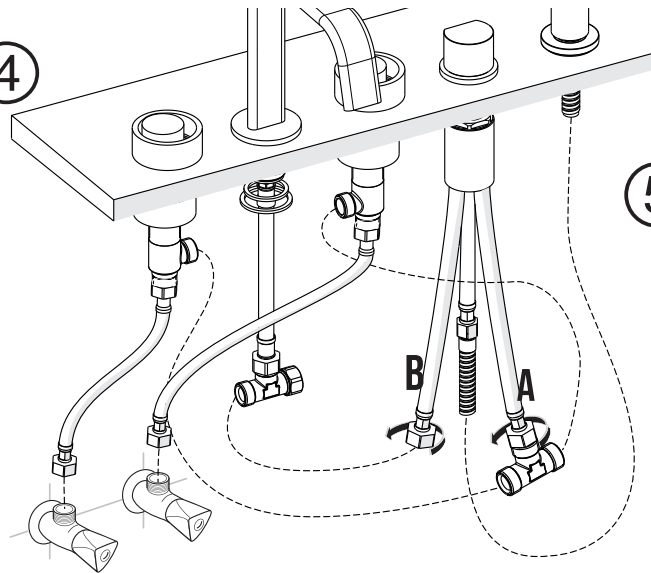

5

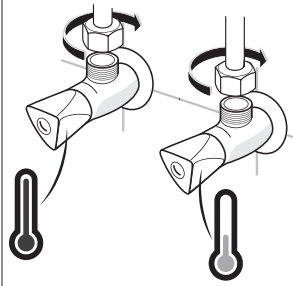

A

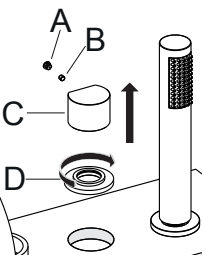
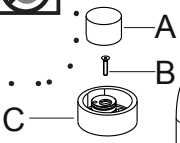
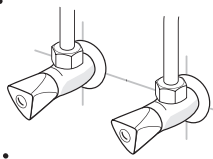

2

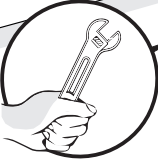
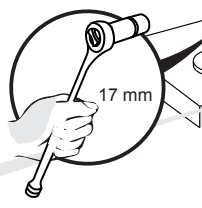
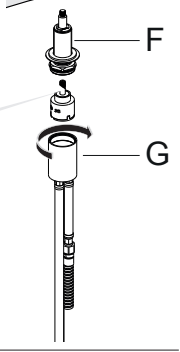

1

B

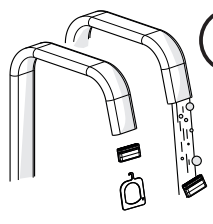
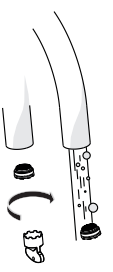

C

