

BAGNODESIGN

EXPERTLY CRAFTED BATHROOMS

Installation Guide

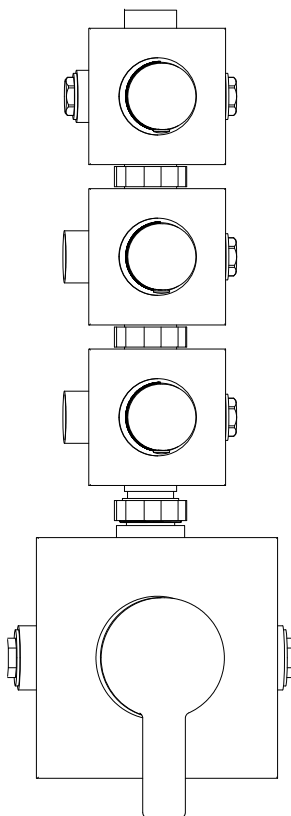

BDM-SPA-M303-XX

BAGNOSPA MANUAL SHOWER MIXER 3 OUTLET

A member of **SANIPEXGROUP**
www.sanipexgroup.com

IMPORTANT PLEASE READ

All products manufactured and supplied by BAGNODESIGN are fit for purpose as long as they are Installed, used correctly, cleaned and receive regular maintenance in accordance with these instructions...

Remove all packaging and check the product for damage or missing parts before commencing with the installation.

Any alterations made to this product and its components may infringe product certification, infringe water regulations and invalidate the guarantee. The Installation must comply with all local/national water supply authority regulations/bylaws and building and plumbing regulations, therefore we strongly recommend that your product be installed by a reputable qualified trade's person.

PRODUCT LIFECYCLE

"The product LiveCyclele is the collective stages that a product goes through from its conception and design through to its ultimate disposal."

DISPOSAL GUIDANCE

The best way to ensure your Product has a long life is to follow the Care and Maintenance guides set by the Manufacture after purchase. This document can be found at www.sanipexgroup.com.

The life cycle of the product is not in correlation to the product Guarantee; the standards the products are manufactured or certified to (e.g. CE & WRAS) can exceed past the Guarantee duration. After the life cycle of the product is deemed complete by the end-user please follow the below to dispose of the items correctly...

Mixers (Taps):

If the mixers are no longer accepted due to mechanical use or aesthetic style, these can be disposed of at a registered Local Authority waste recycling center where the individual components can be sorted.

CLEANING CARE GUIDE

Only use a mild soap and water for cleaning.
Rinse with water to remove the mild soap solution.
We recommend the product is dried using a soft cloth after every use.

Never use any abrasive or strong cleaning products containing, bleaches, acids (hydrochloric, formic, phosphorus, chlorine or acetic), strong detergents, limescale remover, alcohol or dyes etc.

Never use abrasive cleaning pads, wire wool or microfibre cloths.
Never use cleaning equipment that may have been pre-used and contaminated with the above substances.

Never apply the cleaning product directly onto the finished surface.

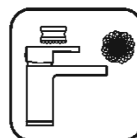

Carryout grooving according to the dimensions of the actual product.

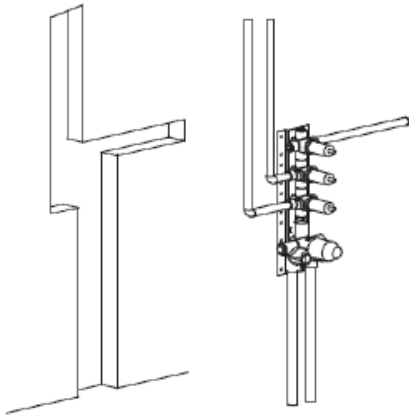

Embedding range of split panel and valve.

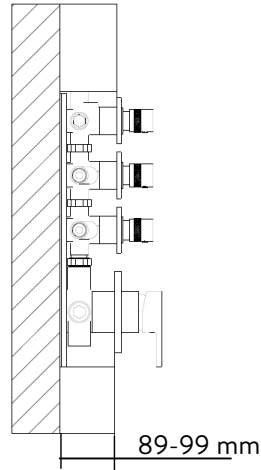

Note: the wall surface should be finished surface or tiled surface.

Take out the hand wheels, female thread sockets, panel and PVC pipes, and then install the 52 jacket and 30 jackets. Keep the female thread sockets, panel, hand wheels and other parts properly, and avoid loss, bumps or scratching.

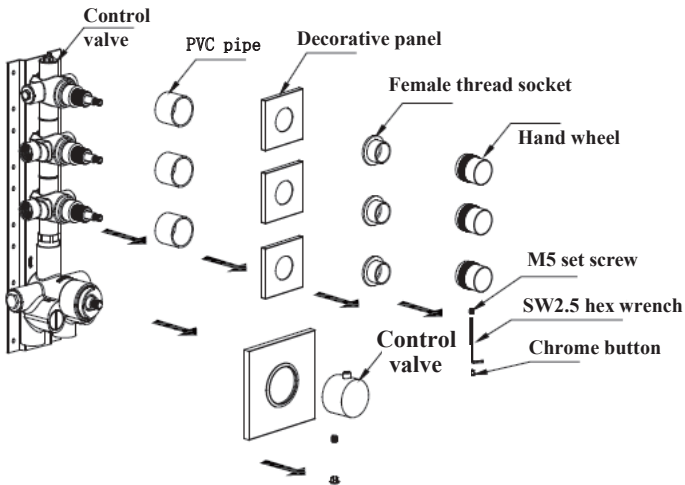

Drill 4 mounting holes in the wall with an electric drill (The hole diameter shall not be greater than the diameter of the self-tapping screw, and refer to the embedded back plate hole layout for the hole positions).

Turn on the valve, remove silt, sand and other impurities in the pipes, and then turn off the valve.

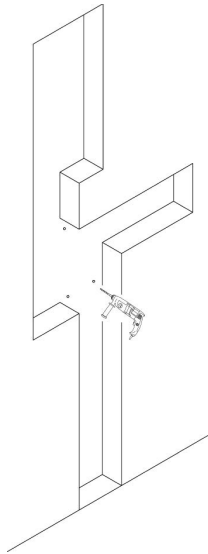

Connect the control valve to the pipes.

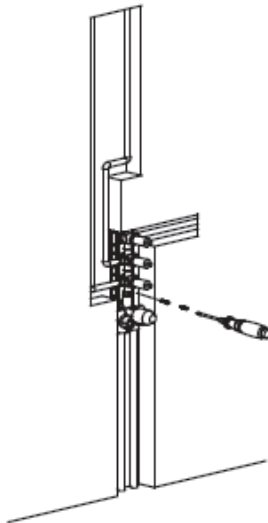

Turn on the valve and observe for 5-10 minutes, check whether the connections are tight and make sure there is no leakage or seepage, and then turn off the valve. Fix the control valve. Fix the valve in the slot using self-tapping screws and plastic expansion plugs.

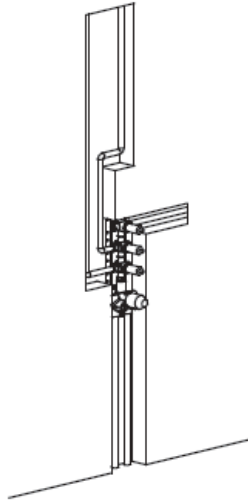

Drill holes in the tiles, & pave the tiles.

Note: Cement shall not to be used to fill the area around the valve.

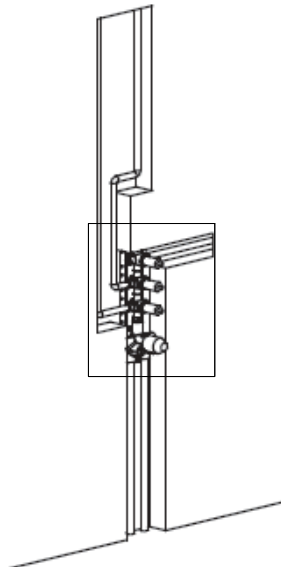

Pull out th jackets, & install the panel, female thread sockets, hand wheels and other parts.

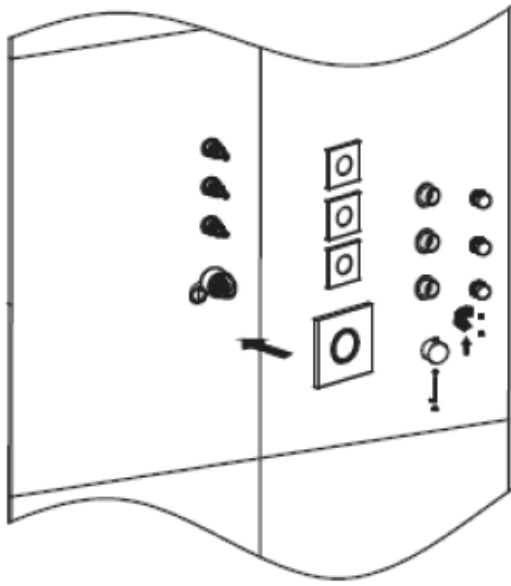

Installation complete.

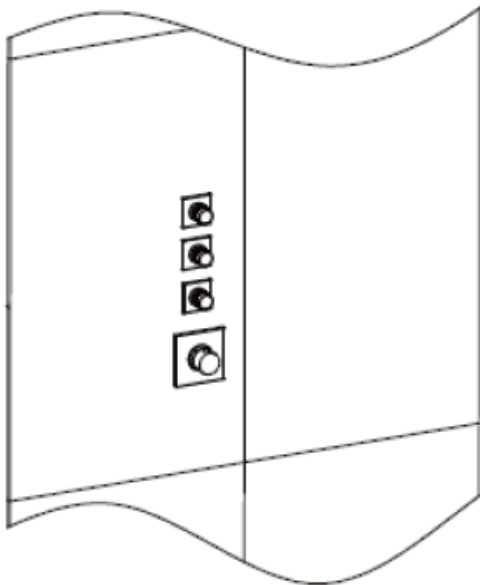

Cleaning

All surface should be cleaned using a clean damp cloth. No abrasive cleaning agents or materials should be used.

BAGNODESIGN

EXPERTLY CRAFTED BATHROOMS

A member of SANIPEXGROUP
www.sanipexgroup.com