

BAGNODESIGN KOY

BDR-KOY-R800-A

WALL MOUNTED ROUND ILLUMINATED MIRROR

INSTALLATION AND MAINTENANCE GUIDE

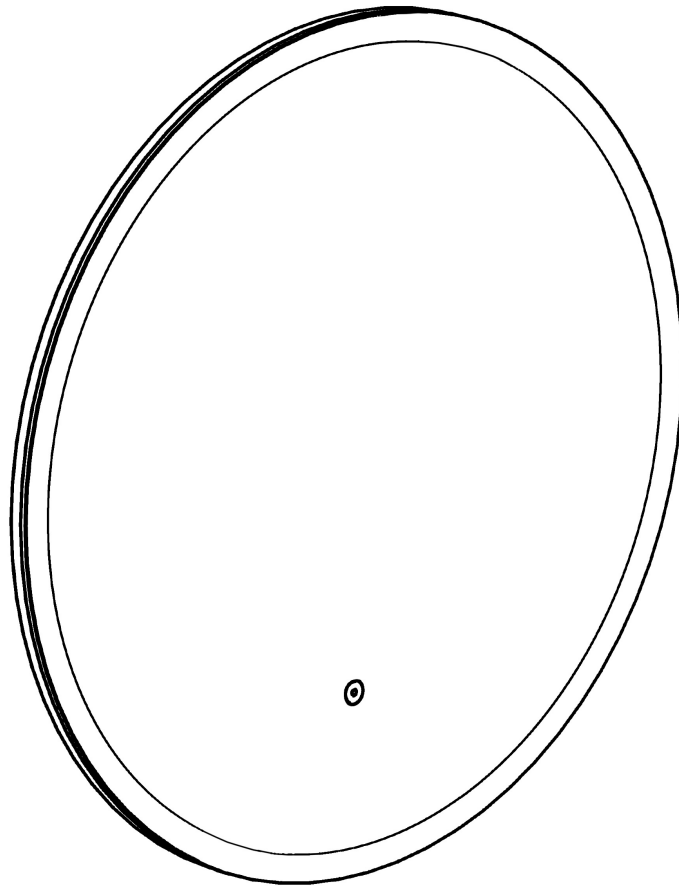

SANIPEXGROUP

COMPONENTS

COMPONENTS PROVIDED

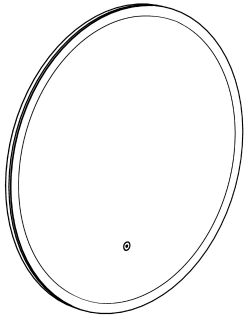

x1 MIRROR



x2 SCREW



x2 WALL PLUG

TOOLS REQUIRED



x1 DRILL

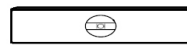

x1 SPIRIT LEVEL

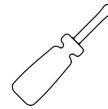

x1 SCREW DRIVER

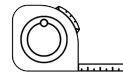

x1 MEASURE TAPE



x1 PENCIL

ATTENTION

IMPORTANT PLEASE READ

All products manufactured and supplied by BAGNODESIGN are fit for purpose as long as they are Installed, used correctly, cleaned and receive regular maintenance in accordance with these instructions.

Remove all packaging and check the product for damage or missing parts before commencing with the installation.

Any alterations made to this product and its components may infringe product certification, infringe water regulations and invalidate the guarantee. The Installation must comply with all local/national water supply authority regulations/bylaws and building and plumbing regulations, therefore we strongly recommend that your product be installed by a reputable qualified trade's person.

DISPOSAL GUIDANCE

The best way to ensure your product has a long life is to follow the Care and Maintenance guides set by the Manufacture after purchase. This document can be found at www.sanipexgroup.com.

The life cycle of the product is *not* in correlation to the product Guarantee; the standards the products are manufactured or certified to (e.g. CE & WRAS) can exceed past the Guarantee duration.



PRODUCT CLEANING

We recommend cleaning with a soft damp cloth and mild soap solution.

DO NOT use cream cleaners or cleaners containing bleach.

DO NOT scrub or scour.

DO NOT use abrasive cleaning agents.

DO NOT use solvent based cleaners.

ATTENTION

Electrical Connections

All electrical connections and alterations should be carried out by a qualified electrician and be in accordance with Part P regulations.

All **BAGNODESIGN** mirrors are IP rated to different standards and are suitable for installation in various zones. The diagram below illustrates this zonal concept and must be followed to ensure safe installation of electrical bathroom products.

The diagrams and information below are a guide to Bathroom Zones as referred to in IP ratings it is important to install an electrical product in the correct bathroom zone i.e. the zone referred to in the IP rating of the product. This is not an installation guide, and reference should be made to the latest edition of the IEE wirings Regulations or a qualified electrician.



Zone 0 is inside the bath or shower tray itself. Any appliance used in this zone must be rated at least IP67 which is total immersion proof.

Zone 1 is the area above the bath or shower tray to a height of 2.25m from the floor. In this zone a minimum rating of IP44 is required and products must also be protected by a 30mA residual current device (RCD) to protect the circuit. The electrical connection to the power supply for these products must be in Zones 2/3 of the bathroom in compliance with BS7671:2001 - IEE Wiring Regulations.

Zone 2 is an area stretching 0.6m outside the perimeter of the bath and to a height of 2.25m from the floor. In this zone an IP rating of at least IP44 is required. In addition, it is good practice to consider the area around a washbasin, within a 60cm radius of any tap to be considered as zone 2.

INSTALLATION

PRODUCT DIMENSION

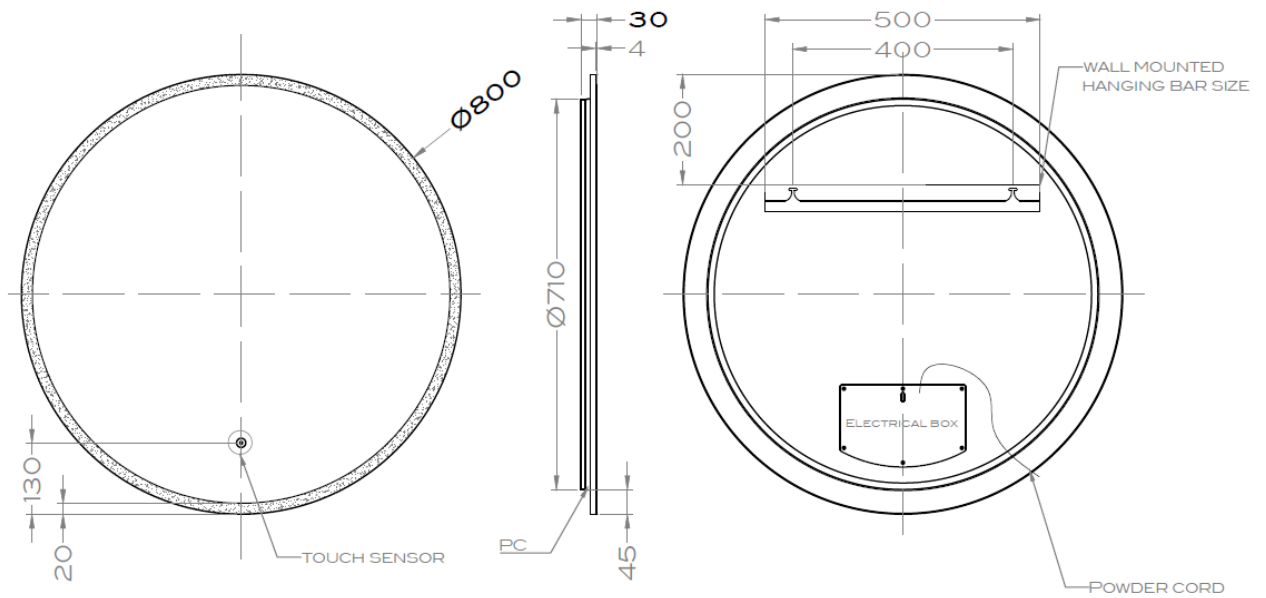

1

A

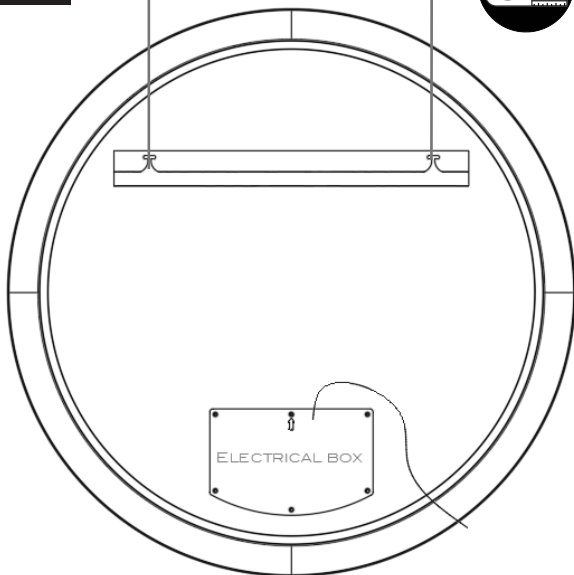

BACK OF THE MIRROR

2

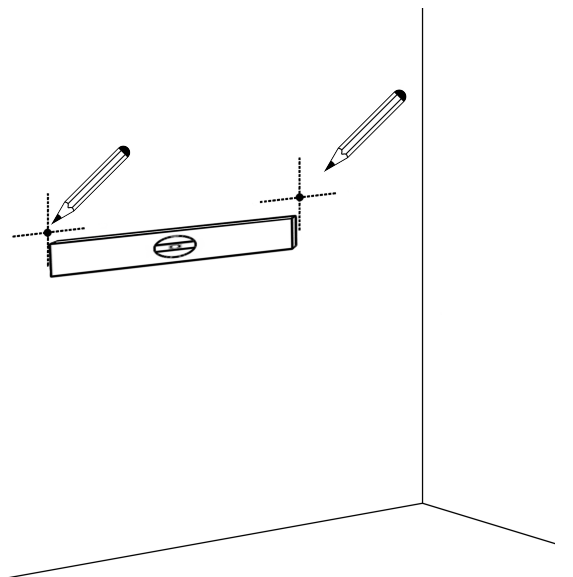

INSTALLATION

3

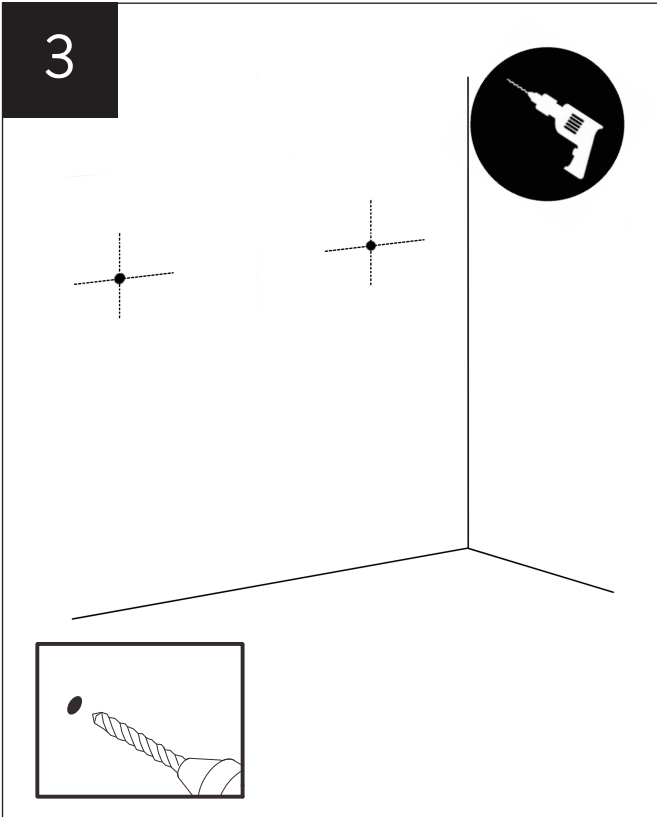

4

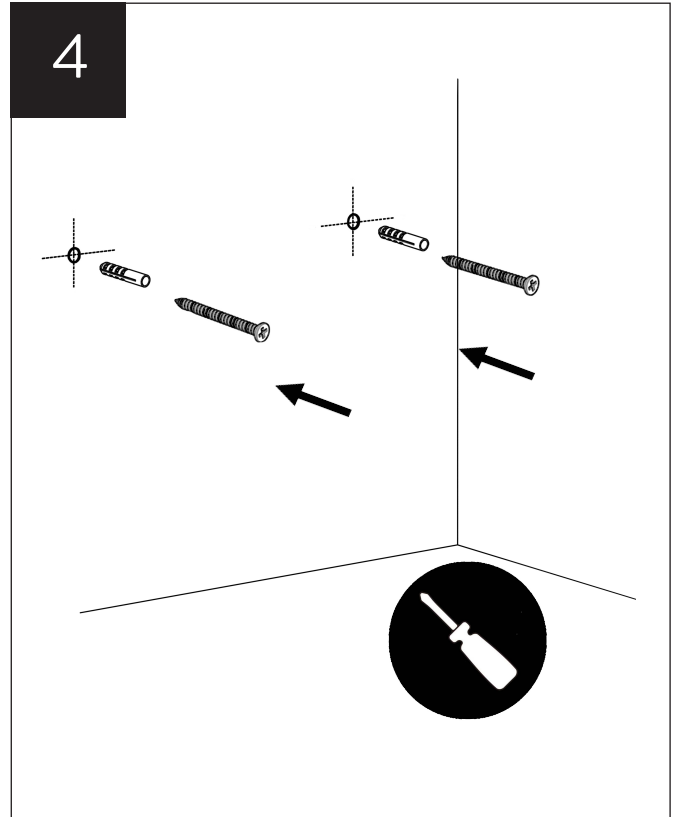

5

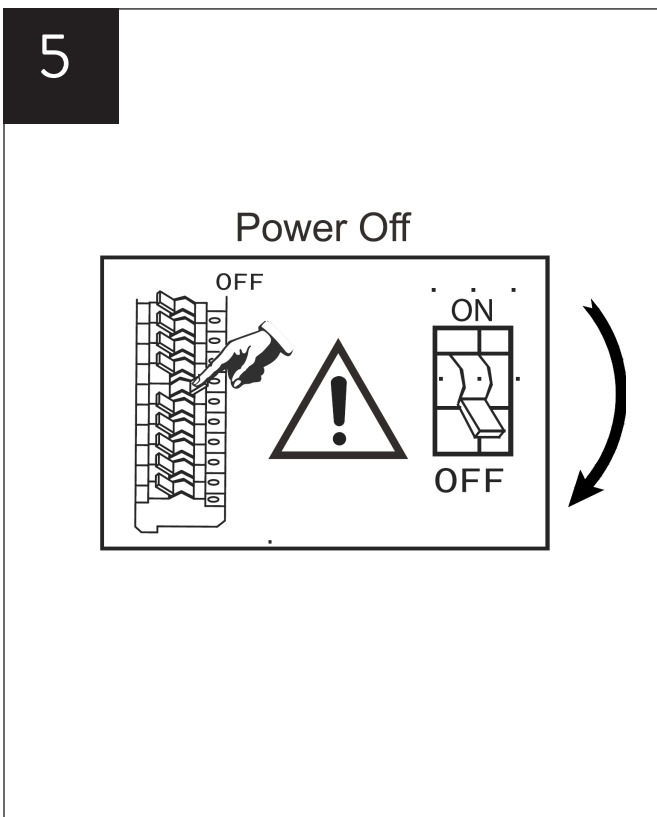

6

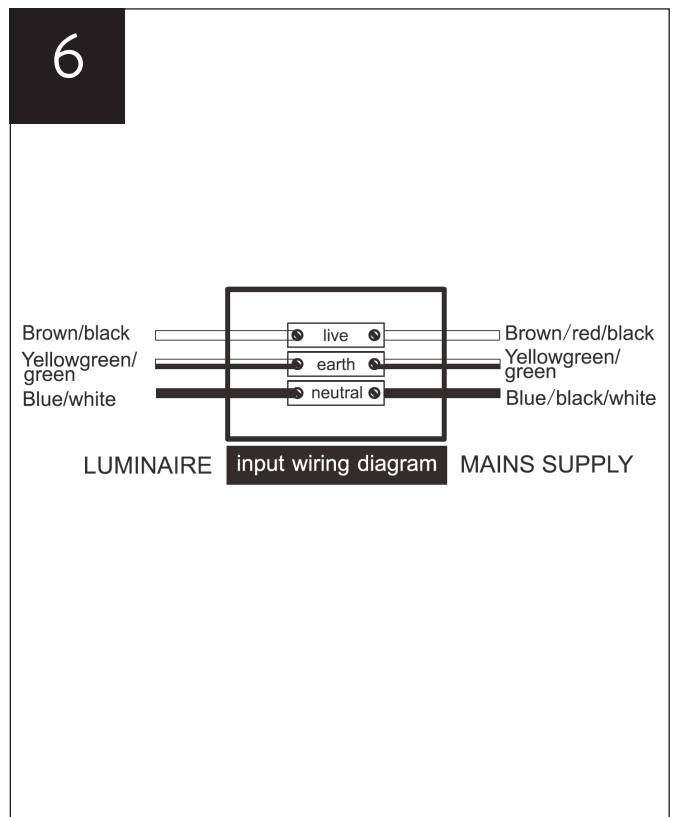

INSTALLATION

7

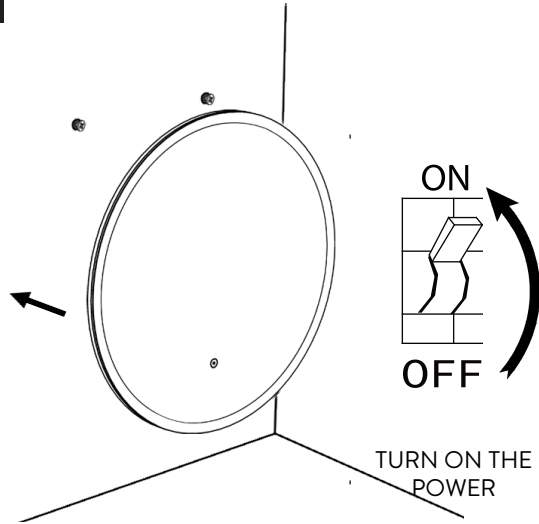

HANG UP THE MIRROR,
SHAKE LEFT AND RIGHT TO
SEE IF IT IS STABLE

8

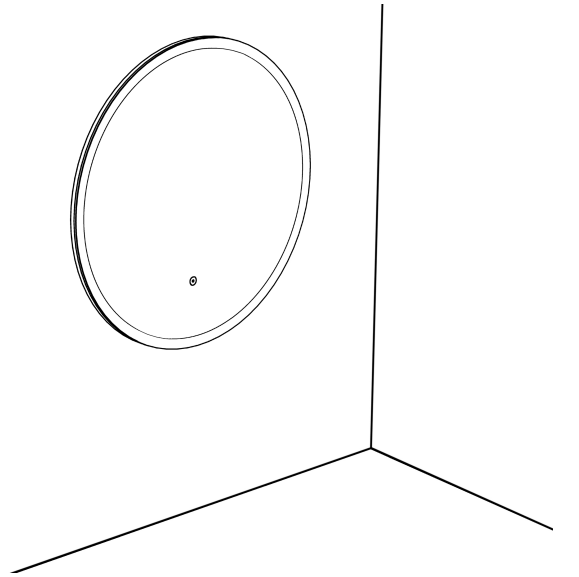

WARRANTY

Sanipex Group warrants that all Products will be free from manufacturing defects and design defaults on the date of purchase and for the duration mentioned in the Product Technical Specification sheet (“Warranty Period”).

Liability of Sanipex Group shall be limited to either repairing or replacing the faulty Products, at its sole discretion, if the same are within the Warranty Period. If Sanipex Group has ceased manufacturing the Product and is unable to replace the Product or provide a suitable part, Sanipex Group will offer to replace the Product with a suitable alternative product that matches the Product as closely as possible.

This warranty shall not be applicable on third party products and in such cases the warranty terms of the concerned third party shall apply.

For further details and information about our Warranty conditions and where certain exclusions may apply, please visit www.sanipexgroup.com/c/warranty

BAGNODESIGN

For more information visit www.bagnodesign.it



SANIPEXGROUP

This installation guide is for reference only. In case there is a discrepancy between that of the instructions and that of the actual product, the latter should be taken as standard. The rights of modification are reserved.