

BAGNODESIGN

EXPERTLY CRAFTED BATHROOMS

Installation Guide



BDR-STR-MIRROR
STRATOS BACKLIT MIRRORS

A member of **SANIPEXGROUP**
www.sanipexgroup.com

IMPORTANT PLEASE READ

Remove all packaging and check the product for missing parts or damage before starting installation.

Any alterations made to this product and fittings may infringe water regulations and invalidate the guarantee.

The Installation must comply with all Local/National Water Supply Authority Regulations/Byelaws and Building and Plumbing Regulations.

We strongly recommend that your product be installed by a reputable qualified trade's person.

General Installation:

To the Installer, please read and follow this instruction carefully, as the guarantee is only valid if the product is installed as directed.

Don't rush, read the instructions first and run through them before you begin. Keep fittings together to avoid loss. Do not over tighten screws or bolts.

If the product is covered with polyethylene protective film, do not remove until installation is complete to grant maximum protection. However, remove film where any two surfaces will be in permanent contact.

Please leave this installation manual with the end user once the product has been installed.

Product Aftercare:

We recommend cleaning with a soft damp cloth and mild soap solution. Do not use cream cleaners or cleaners containing bleach.

Do not scrub or scour.

Do not use abrasive cleaning agents.

Do not use solvent based cleaners.

Electrical Connections

All electrical connections and alterations should be carried out by a qualified electrician and be in accordance with Part P regulations.

All **BAGNODESIGN** mirrors are IP rated to different standards and are suitable for installation in various zones. The diagram below illustrates this zonal concept and must be followed to ensure safe installation of electrical bathroom products.

The diagrams and information below are a guide to Bathroom Zones as referred to in IP ratings it is important to install an electrical product in the correct bathroom zone i.e. the zone referred to in the IP rating of the product. This is not an installation guide, and reference should be made to the latest edition of the IEE wirings Regulations or a qualified electrician.

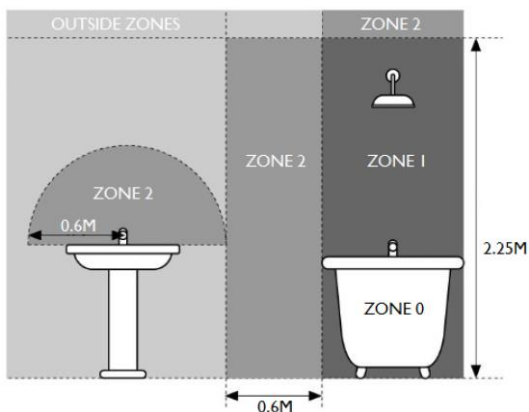

Zone 0 is inside the bath or shower tray itself. Any appliance used in this zone must be rated at least IP67 which is total immersion proof.

Zone 1 is the area above the bath or shower tray to a height of 2.25m from the floor. In this zone a minimum rating of IP44 is required and products must also be protected by a 30mA residual current device (RCD) to protect the circuit. The electrical connection to the power supply for these products must be in Zones 2/3 of the bathroom in compliance with BS7671:2001 - IEE Wiring Regulations.

Zone 2 is an area stretching 0.6m outside the perimeter of the bath and to a height of 2.25m from the floor. In this zone an IP rating of at least IP44 is required. In addition, it is good practice to consider the area around a washbasin, within a 60cm radius of any tap to be considered as zone 2.

Function

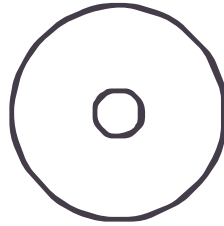

"Switch sign"

Sensor switch "ON / OFF"

Parts list

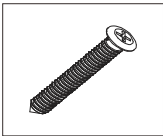

M4 screw

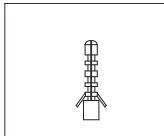

D6 expansion screw

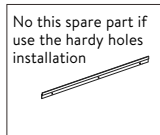

Aluminum hanging bar

Installation tools (as shown below)

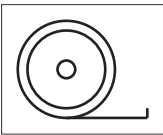

Flexible rule

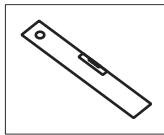

Leveling instrument

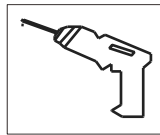

Churn drill

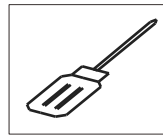

Screwdriver

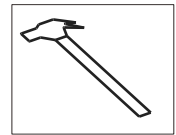

Hammer

Warm tips,

- 1, Please do not use, if the product is broken.
- 2, During operation, never put hard and sharp materials directly against the mirror surface. Otherwise, it may result in current leakage and even personal injury accident
- 3, Please pull out the power plug if the product is not used for a long time.

A/ Hanging bar Installation Manual (Instruction for LED bathroom mirror)

b (portrait installation method)

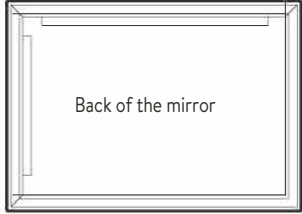

a (landscape installation method)



Please choice portrait or landscape installation method first

Horizontal the hanging bar mark with a pen in the hanging bar hole

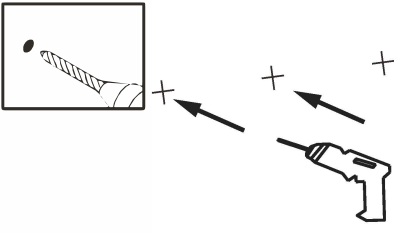

To use the drill to have the holes

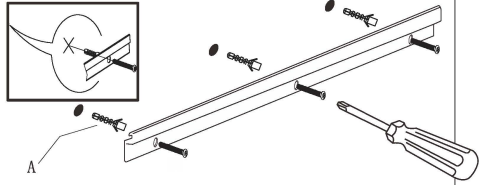

(A just apply to the solid wall)

1 Put the expansion plug into the wall hole , both the wall holes and the hanging bar holes are match. to use the screwdriver to make the screw tightly

Power Off

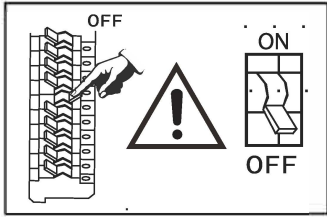

Please cut off all the power before the connection

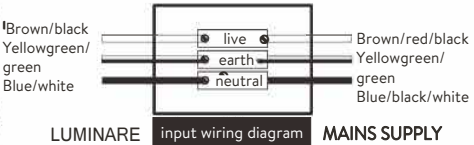

To connect as per above photo

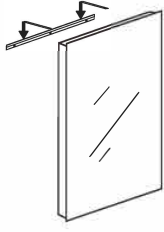

Hang up the mirror shake left and right to see if it is stable

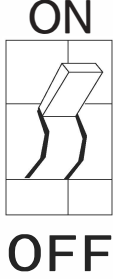

Turn on the power

B / Hardy Holes Installation Manual (Instruction for LED bathroom mirror)

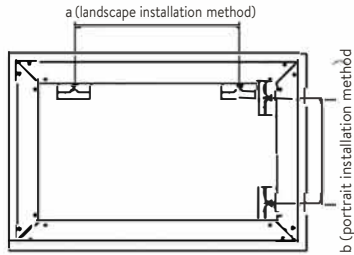
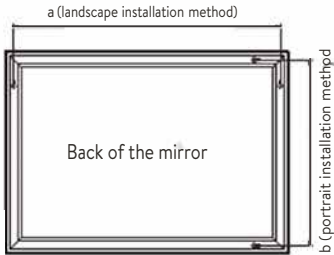

please choice portrait or landscape installation method first
To use the measure tape to measure to distance between the two holes

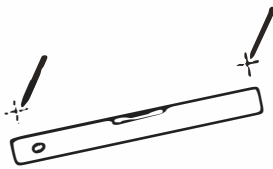

Horizontal the level ruler
Mark the distance between two holes on the wall with a pen

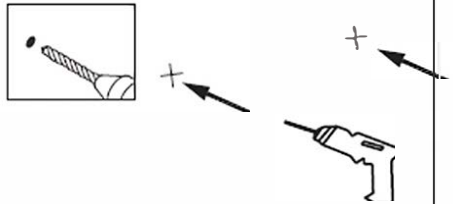

To use the drill to have the holes

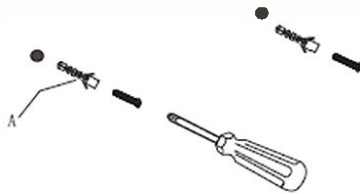

(A just apply to the solid wall)
1 Put the expansion plug into the wall hole , both the wall holes and the hanging bar holes are match. to use the screwdriver to make the screw tightly

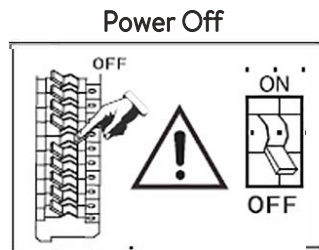

Please cut off all the power before the connection

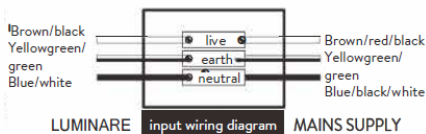

To connect as per above photo

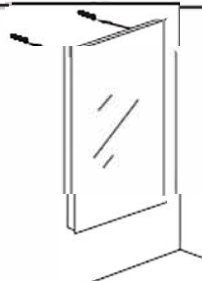

Hang up the mirror shake left and right to see if it is stable

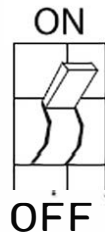

Turn on the power

BAGNODESIGN

EXPERTLY CRAFTED BATHROOMS
