

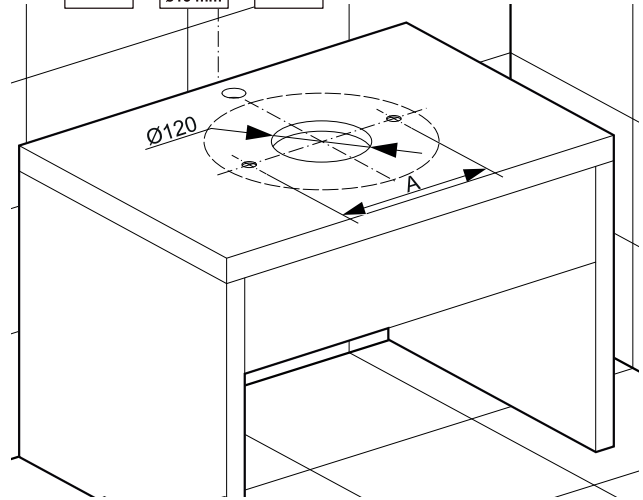

GRACE

**AXENT**  
SWITZERLAND

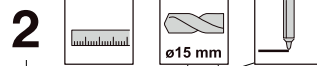
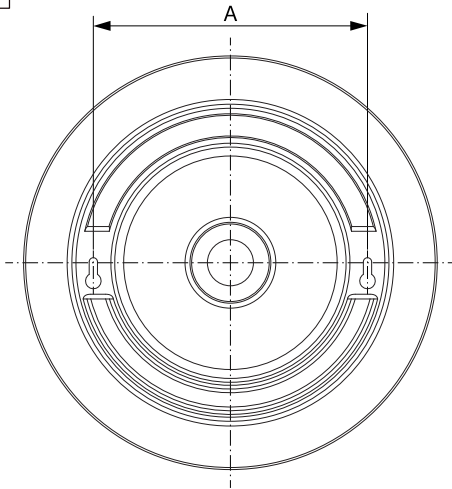

**3**

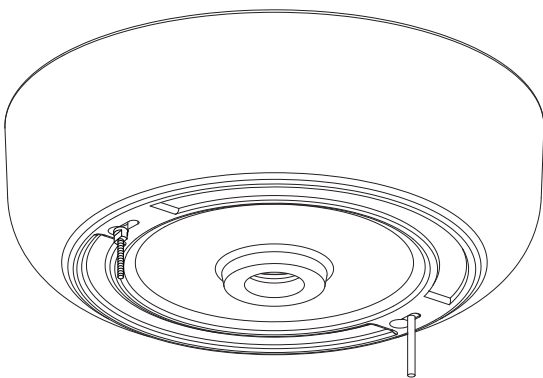

**4**

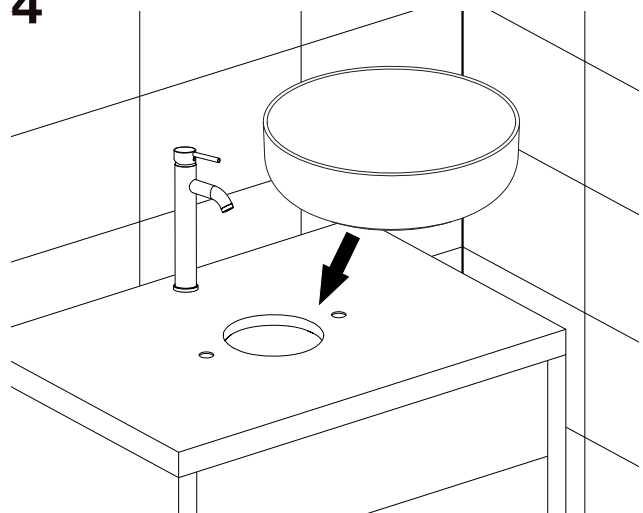

**5**

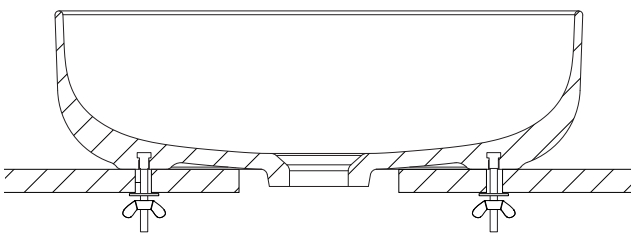

**6**

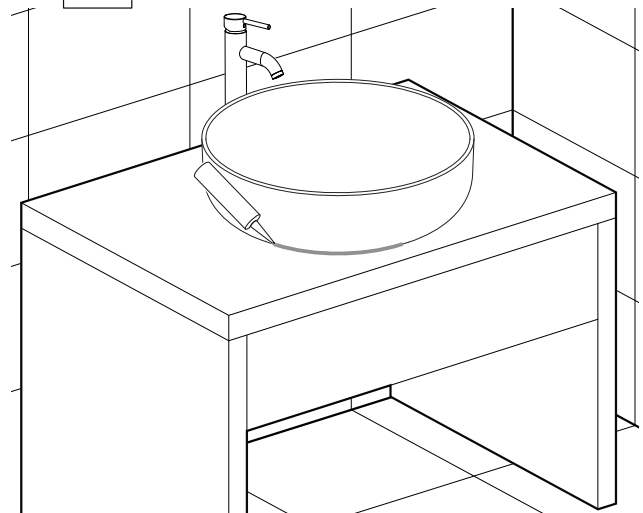

224032509400 / 2018.1.2

**AXENT International AG**

info@axentbath.ch

www.axentbath.ch