

DS102

DOLPHIN WALL PLATE MOUNTED INFORM (SMART) TAP

INSTALLATION AND MAINTENANCE GUIDE



Highly reflective surfaces directly beneath the sensor of this product, in particular polished finish basin wastes/strainers, will cause false activation of the infrared sensors and can result in malfunction. We recommend satin or matt finish products which can be found on our website.



PRODUCT CODES

- > DS102.130 130mm projection
- > DS102.180 180mm projection
- > DS102.230 230mm projection
- > DS102.280 280mm projection
- > DS102.330 330mm projection

TECHNICAL HELPLINE 01424 202224
DOLPHINSOLUTIONS.CO.UK

DS102

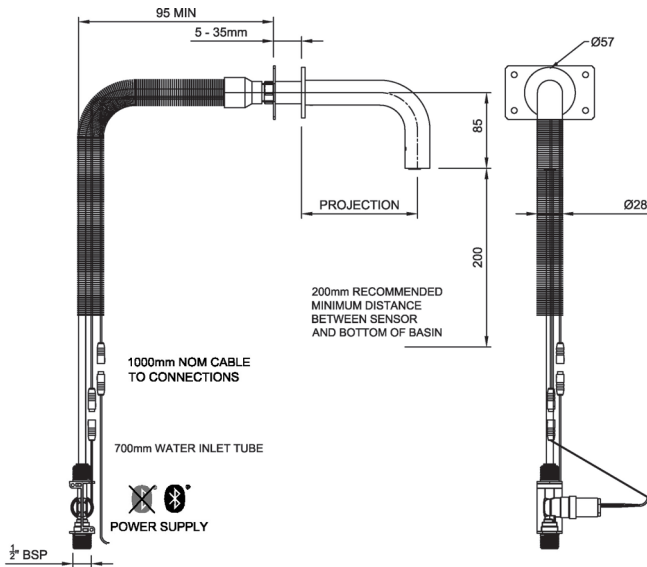

TECHNICAL DATA

- › Dolphin Wall Plate Mounted InForm (SMART) Tap
- › Manufactured from high-quality, highly durable 1.4401 (316) Marine grade stainless steel.
- › Self-Monitoring Analysis and Recording Technology (SMART) allows the Facilities Manager to connect point to point via the Dolphin SMART App when used with the optional Bluetooth Adaptor (Sold separately -Order product code 25148)
- › Infra-Red Touch Free Tap – for ultimate hygiene – prevents cross contamination
Sensor mounted in end of spout
- › Designed to be front mounted for when rear access installation is not possible
- › Flow rate - 3.78 litres/minute with the standard fitted flow regulator (contained within Neoperl TT cache aertor) at any pressure between 0.5 and 6 bar*
- › Other flow rates including 1.89 litres/minute available to special order – please enquire*
- › Water Supply: Single inlet cold or pre-mixed – a TMV2 or TMV3 thermostatic mixing valve is recommended for premixed applications
- › Maximum operating water temperature - 65°C
- › Power Supply: *
- › Nominal Current: Less than 1mA (Less than 25mA with Bluetooth)
- › Nominal Power: Less than 1W
- › Security Time can be adjusted via the App
Default 20 Seconds (60 Seconds max)
- › IP68 Connector

* See page 4 for flowrates and other options

PRODUCT CODES

DS102.130	› 130mm Projection
DS102.180	› 180mm Projection
DS102.230	› 230mm Projection
DS102.280	› 280mm Projection
DS102.330	› 330mm Projection

Coding Explained

Style

DS102 90° Bent Spout - Wall Mounted
DS10X.XXX.X

Projection

130/180/230/280/330mm
DS10X.XXX.X

Finish

1 Brushed Satin
2 Mirror Polished
3 PVD Brushed
4 PVD Mirror
5 Powder Coated
DS10X.XXX.0

Colour

Suffix to end of code

(Number allocated by Dolphin Solutions)

Example Coding DS102.130.1

90° Bent Spout
130mm Projection
Brushed Satin Finish

Options

Bluetooth 
PVD
Powder Coating

PACK CONTENTS

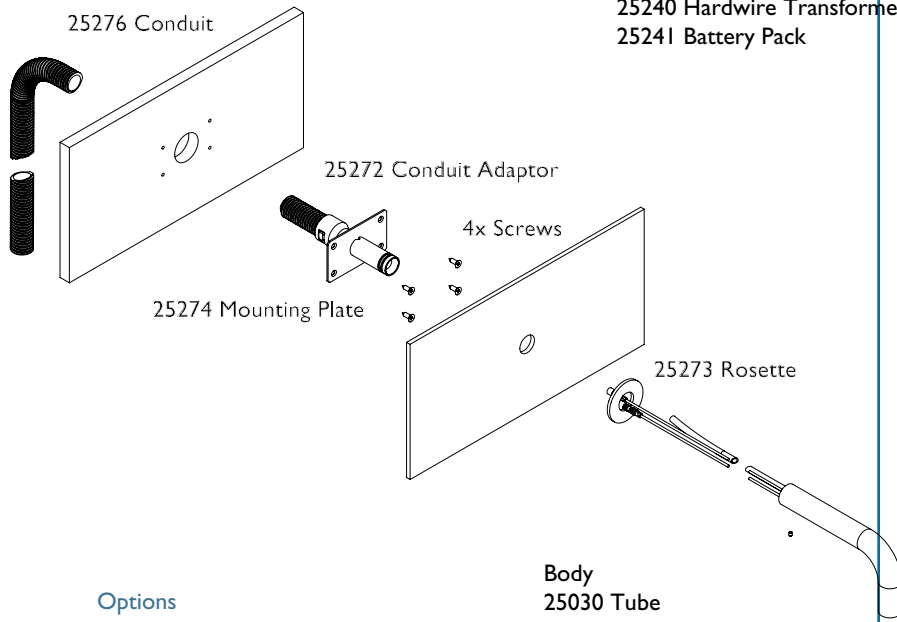

Power Supply Options:
 25147 UK Mains Adaptor
 25428 EURO Mains Adaptor
 25240 Hardwire Transformer
 25241 Battery Pack

Options



Body
 25030 Tube
 25275 Tail
 25146 Sensor Assembly
 25040 Aerator Housing
 25041 Aerator

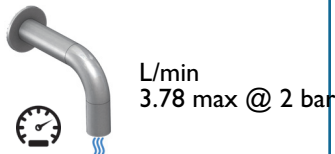
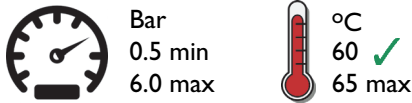

PRE INSTALLATION

- › Ensure all contents has been accounted.
- › Do not install shiny objects in line with the sensor.

⚠ WARNING

- › All plumbing and Electrical installation must be carried out by a qualified person and in accordance with applicable codes and regulations.
- › Do not remove black label covering the infra-red sensor until the installation is ready to be switched on.
- › Do not kink the water supply hose.

INSTALLATION

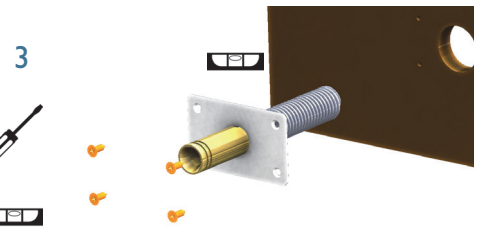
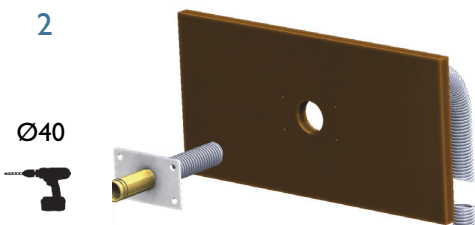
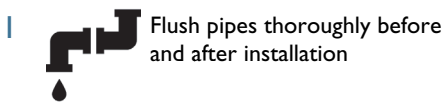

Fit the wall mounting plate with 4 screws supplied. **IMPORTANT** ensure wall plate is level as this dictates tap angle and rotation. Protect Mounting plate with low tack tape / other suitable method

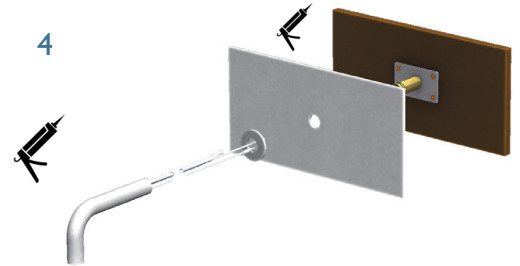

Fit Glass Splashback with adhesive (or other fixing method as required) leaving mounting assembly protruding
 Fit Rosette over mounting assembly
 Insert plugs, cables and then pipe from the tap into mounting assy and feed through

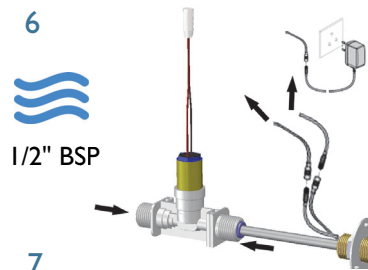
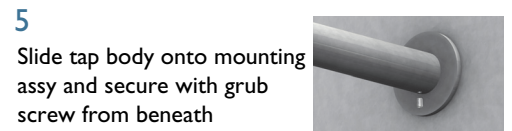

- › Remove Label that covers the sensor.
- › Switch on power supply
- › Wait 15 seconds for sensor to adjust. Red light in sensor eye will flash during self adjustment. The solenoid valve will open and close for 1 second to indicate that the sensor has been set and is ready for use.

If the sensor fails to set, please see SMART App manual for corrective action.

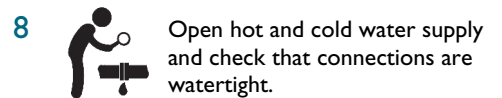

MAINTENANCE

DO NOT use steel wool or cleansing agents containing alcohol, acid, abrasives or the like. Use of any prohibited cleaning or maintenance products or substances could damage the surface of the tap. For surface cleaning of tap use ONLY soap and water then wipe dry with a clean soft cloth. Protect taps from splattering of harsh cleansers when cleaning surroundings.

OPTIONS

Flow Rate Curve

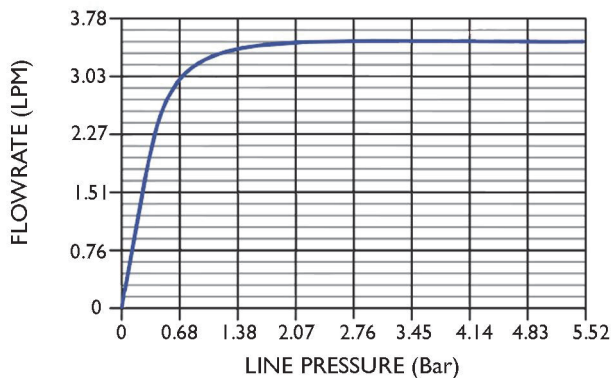

— PCA

PCA® Perlator®
Faucet Aerator - 3.78 lpm max
 Pressure Compensating Tom Thumb® Size

Flow Rate Curve

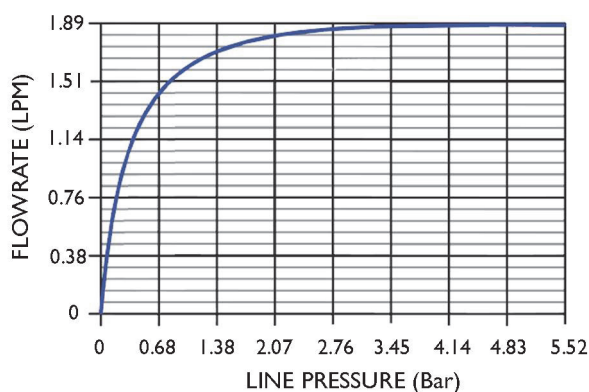

— PCA®

NEOPERL®
 flow, stop and go®

PCA® Perlator®
Laminar Stream - 1.89 lpm max
 Pressure Compensating Tom Thumb® Size

POWER SUPPLY OPTIONS

UK MAINS ADPATOR PRODUCT CODE 25147

(Other Adaptor pin and power supply configurations available upon request):

- › Input voltage: 100 – 240V AC +/- 10%, 50 - 60 Hz
- › Output voltage: 6.75V DC + 0.15V/ -0.35 V
- › Secondary current: 0 - 350 mA DC
- › Buffer capacitors: The adaptor secondary contains 3 buffer capacitors (necessary to close the solenoid valve in case of power outage):
 - 2 x 2200 µF,
 - 1 x 100µF
- Certifications: EN 60335-1, EN 60950-1
- › 1m Cable

HARDWIRE TRANSFORMER PRODUCT CODE 25240

- › Input voltage: 100 – 240V ± 10% 50-60 Hz ± 3 Hz
- › Output voltage: 6.6V DC ± 5%
- › Secondary current: 200 mA DC
- › Buffer capacitors: one buffer capacitor 4700 µF (necessary to close the solenoid valve in case of power outage)
- Certifications: EN 60335-1, EN 61558-2
- › 1m Cable (Transformer to Tap), 2m Cable (Transformer to Mains)

BATTERY PACK PRODUCT CODE 25241

- › Requires a 6V lithium battery (CR-P2, approx. 1.500mAh) which has a lifetime of 200.000 switching cycles or 3-5 years depending on user frequency.
 - › 100mm Cable (Approx)
 - › **Important note** - the battery unit can't be used in combination with the Bluetooth adaptor.
- The battery unit contains the CR-P2 battery as delivery content. The housing enables a fixation on wall by using the mounting clips (part of the housing but screws are not included) or the rear affixed Velcro tape

BLUETOOTH ADAPTOR PRODUCT CODE 25148



Bluetooth® version 4.0.

The **current version** of the app required for using the system **must** be installed on the control unit in advance. The App is available for free in the iTunes Store (requires an Apple account) and the Google Play store (requires a Google account).

For operation under adverse environments, in buildings / rooms with reinforced concrete walls, steel and iron frame, or near of obstructions (eg furniture) of metal, the Bluetooth reception can be disturbed and interrupted.

Bluetooth®:

Power consumption:	Less than 25mA
Output:	Bluetooth® - Class 2
Bluetooth® - version:	4.0
Bluetooth® - Transmission distance:	about 10m (depending on the environments)
Automatic safety shut-off:(10/20/60 seconds - adjustable)	20 s
Run-on time (0 - 10 s adjustable):	1 s
Detection Range - Levels 1 to 10 (10 = 120mm approx)	10