

2200 / 2210 / 4125 / 4135
WALL MOUNTED BASIN & BATH SPOUTS
INSTALLATION GUIDE

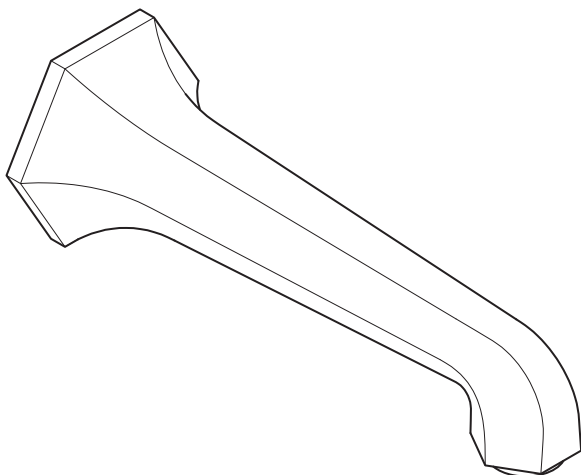

LEFROY BROOKS

IMPORTANT INFORMATION

Professional installation

We recommend that our products are fitted by a fully qualified professional plumber. They should be installed correctly and in accordance with all local water regulations and the system protected by non-return valves (not supplied). All products should be accessible for routine servicing.

Suits all systems

This Lefroy Brooks product is potentially suitable for every possible application, type of boiler and water supply pressure. However, if your supply pressure is below 1 bar it is advisable to fit a water pump. For systems with combination boilers, it is not advisable to fit pumps (refer to boiler manufacturer).

Supply temperature safety notice

A thermostatic mixing valve (TMV) should be fitted (not supplied) to the hot supply to restrict the temperature to a safe working/maximum temperature to comply with local building regulations, current legislation, relevant standards and codes of practice. Maximum allowed temperatures vary subject to type of installation or specification of building.

Flushing system

It is most important to flush out all pipework thoroughly before connecting the product. Failure to do so may block aerators and reduce or prevent water flow.

Supply connections

Lefroy Brooks do not supply any pipework or connections for the spouts. The threaded spout tails can be cut to length to suit the available cavity and connected to the water supplies using a standard tee connection.

Balancing flow

When using wall valves as separate hot and cold supplies, if a significant difference in pressure exists, we advise fitting a 'flow regulator' (not supplied) to the higher or both supplies.

Servicing

Suitable access should be available to aid any future maintenance/servicing. Installing isolation valves will make servicing much easier (not supplied).

All serviceable parts are available to maintain your Lefroy Brooks product (contact retailer for details).

Water quality

In hard water areas a suitable water treatment system should be provided to prevent limescale deposits (calcium deposits). Exterior surfaces should be gently wiped with a dry soft cloth after use to minimise water stains and limescale deposits.

BASIN SPOUT DIMENSIONS

LB 2200 – Classic basin wall spout

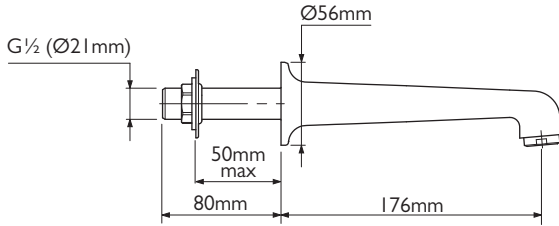

FR 2200 – La Chapelle basin wall spout

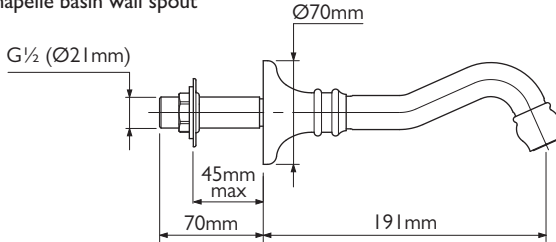

JM 2200 – Janey Mac basin wall spout

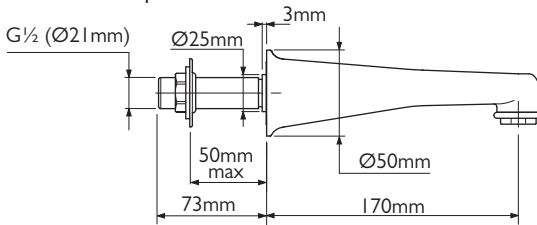

MK 2200 – Mackintosh basin wall spout

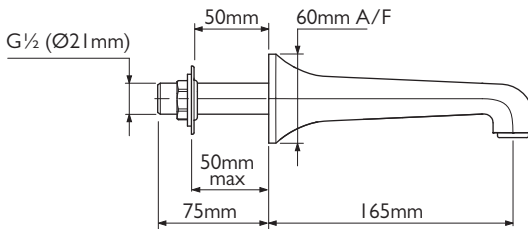

XO 4135 & TT 4135 – Zu basin wall spout

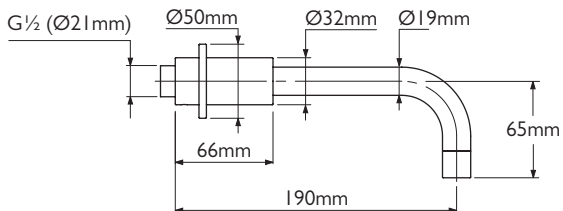

Not to scale

BATH SPOUT DIMENSIONS

LB 2210 – Classic bath wall spout

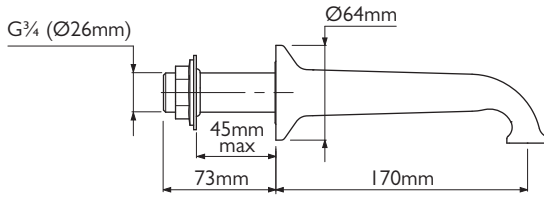

LBE 2210 – Classic bath wall spout

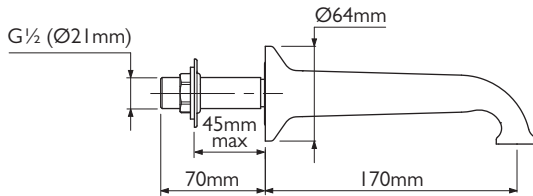

FR 2210 – La Chapelle bath wall spout

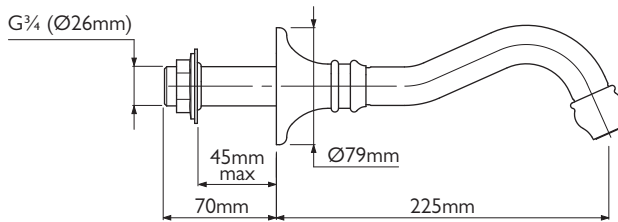

FRE 2210 – La Chapelle bath wall spout

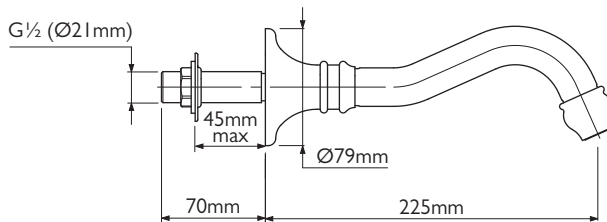

MK 2210 – Mackintosh bath wall spout

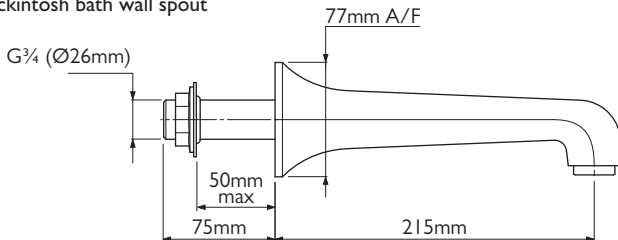

Not to scale

BATH SPOUT DIMENSIONS

JM 2210 – Janey Mac bath wall spout

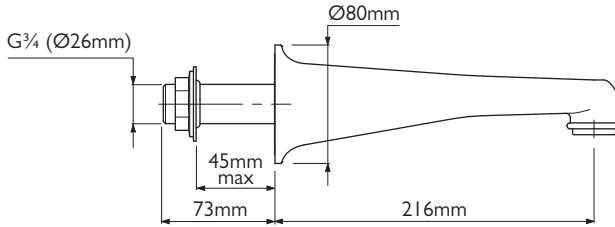

JME 2210 – Janey Mac bath wall spout

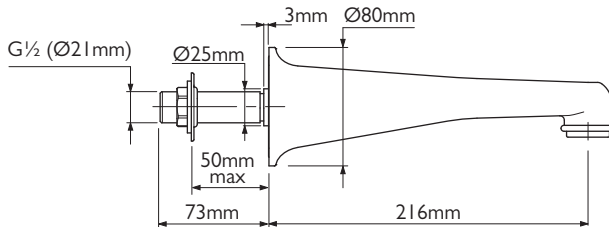

RT 2210 – Belle Aire bath wall spout

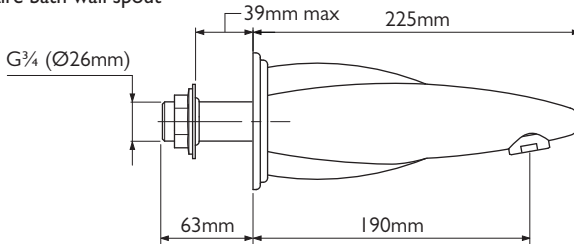

RTE 2210 – Belle Aire bath wall spout

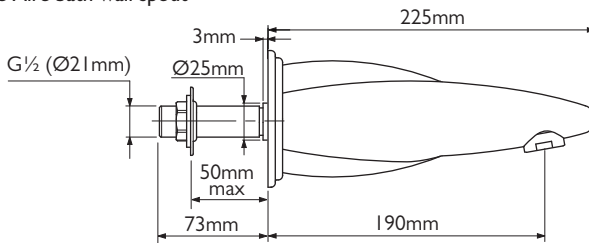

XO 4125 & TT 4125 – Zu bath wall spout

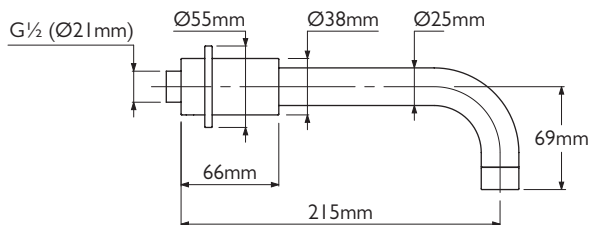

Not to scale

TYPICAL FLOW RATES

LB 2220 & JM 2200 basin wall spouts

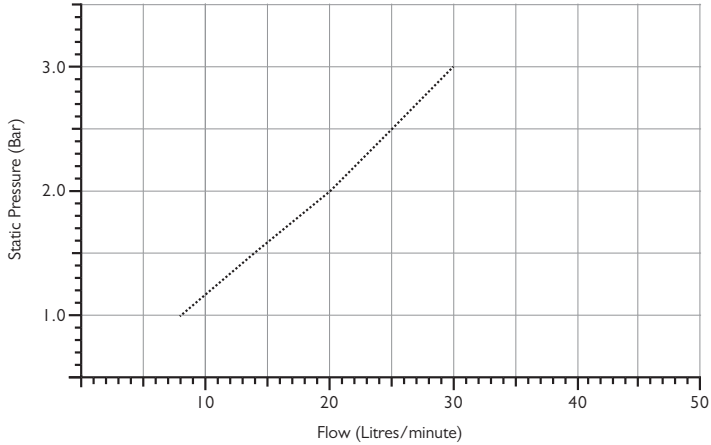

Note: Balanced pressures shown are applied directly to the hot and cold inlets; flow rates indicated are free flowing and may vary subject to restrictions created by installation, pipework, layout or application.

FR 2220 basin wall spout

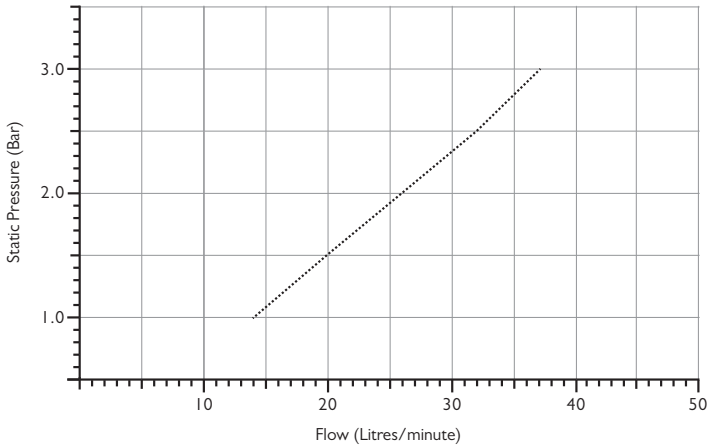

Note: Balanced pressures shown are applied directly to the hot and cold inlets; flow rates indicated are free flowing and may vary subject to restrictions created by installation, pipework, layout or application.

TYPICAL FLOW RATES

MK 2200 basin wall spout

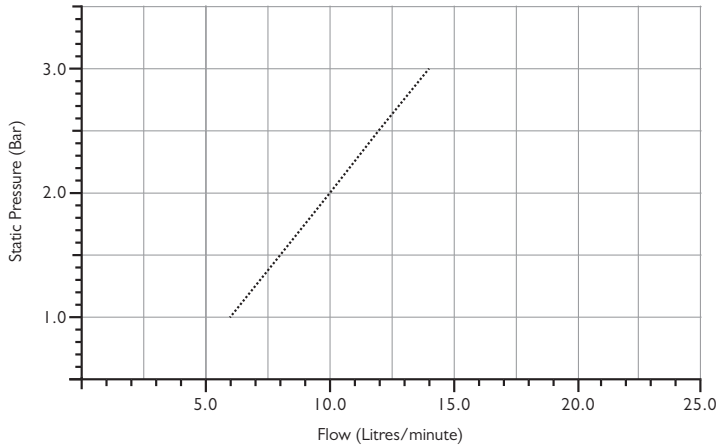

Note: Balanced pressures shown are applied directly to the hot and cold inlets; flow rates indicated are free flowing and may vary subject to restrictions created by installation, pipework, layout or application.

TT 4135 & XO 4135 basin wall spout

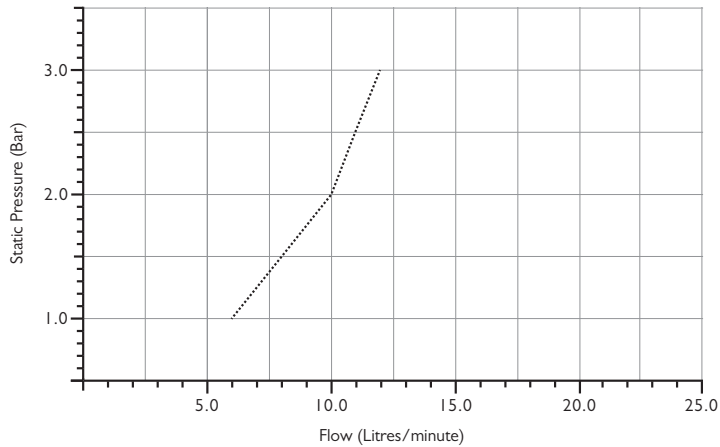

Note: Balanced pressures shown are applied directly to the hot and cold inlets; flow rates indicated are free flowing and may vary subject to restrictions created by installation, pipework, layout or application.

TYPICAL FLOW RATES

LB 2210, LBE 2210, MK 2210, TT 4125 & XO 4125 bath wall spouts

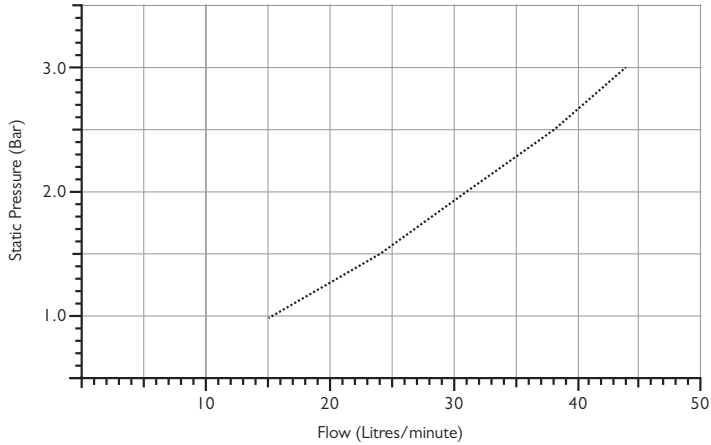

Note: Balanced pressures shown are applied directly to the hot and cold inlets; flow rates indicated are free flowing and may vary subject to restrictions created by installation, pipework, layout or application.

FR 2210 & FRE 2210 bath wall spouts

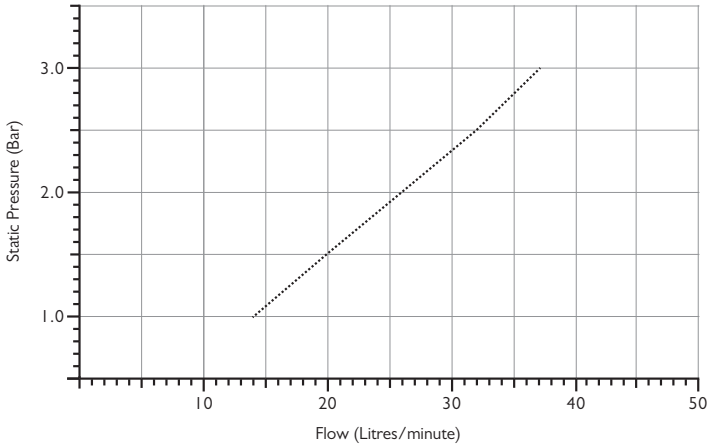

Note: Balanced pressures shown are applied directly to the hot and cold inlets; flow rates indicated are free flowing and may vary subject to restrictions created by installation, pipework, layout or application.

TYPICAL FLOW RATES

JM 2210 & JME 2210 bath wall spouts

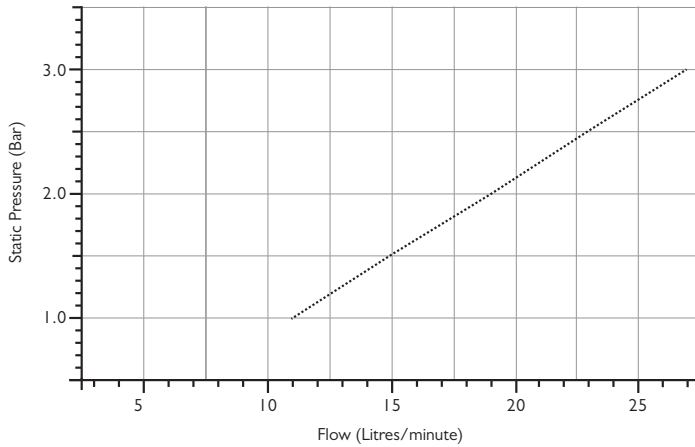

Note: Balanced pressures shown are applied directly to the hot and cold inlets; flow rates indicated are free flowing and may vary subject to restrictions created by installation, pipework, layout or application.

RT 2210 & RTE 2210 bath wall spouts

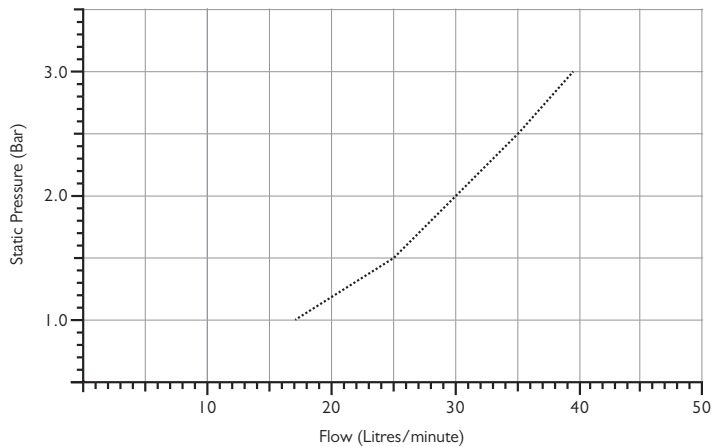

Note: Balanced pressures shown are applied directly to the hot and cold inlets; flow rates indicated are free flowing and may vary subject to restrictions created by installation, pipework, layout or application.

INSTALLATION

(All models except TT 4125, TT 4135, XO 4125 & XO 4135)

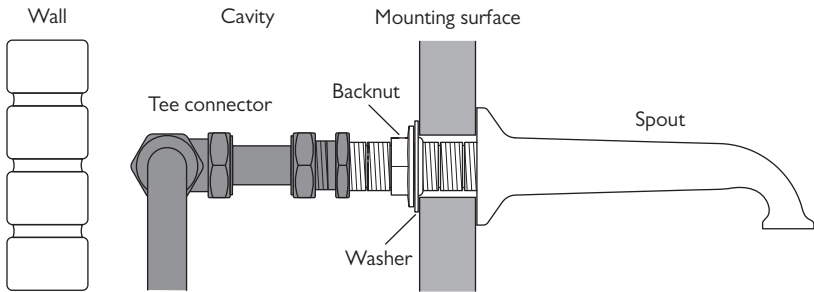
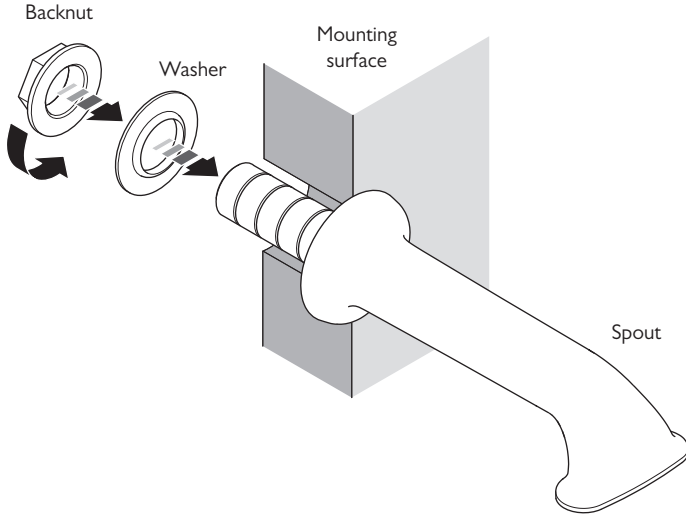

Spouts are not suitable for solid walls.

- 1 Drill a suitable sized hole through the mounting surface.
- 2 Insert the spout tail through the opening in the mounting surface.
- 3 Locate the washer on to the spout tail.
- 4 Screw the backnut on to the spout tail.

INSTALLATION

TT 4125, TT 4135, XO 4125 & XO 4135 only

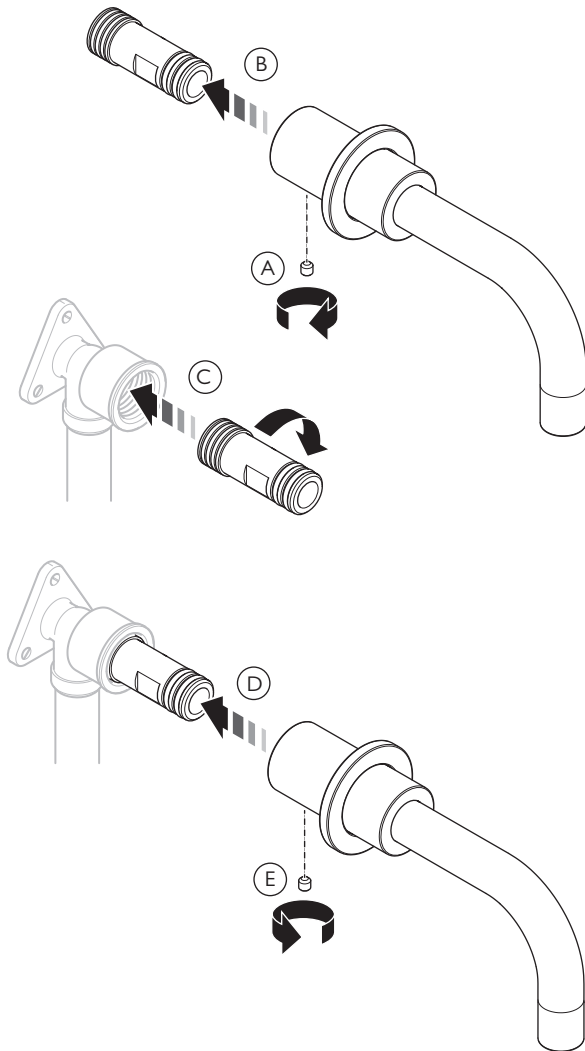

- 1 Unscrew and remove the grub screw from the base of the spout using the supplied 2.5mm hexagonal key (A).
- 2 Pull the wall adapter clear of the spout body (B).
- 3 Apply suitable sealing compound/tape to the thread of the wall adapter and screw into a suitable female wall fitting (C).
- 4 Gently push the spout onto the wall adapter (D) then fit the grub screw to secure (E).

TYPICAL LAYOUT

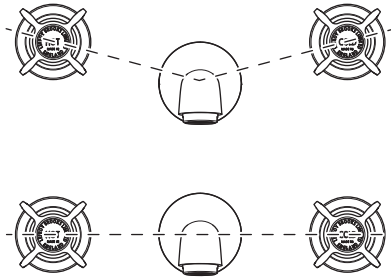

There are no regulations specifying the position between spout and valves.
They can be installed as required.

SERVICING – CLEANING THE AERATOR/FLOW STRAIGHTENER

Shown with Janey Mac bath spout.
The same procedure applies to all models fitted with aerators/flow straighteners.
Not applicable to Classic bath spout (LB 2210).

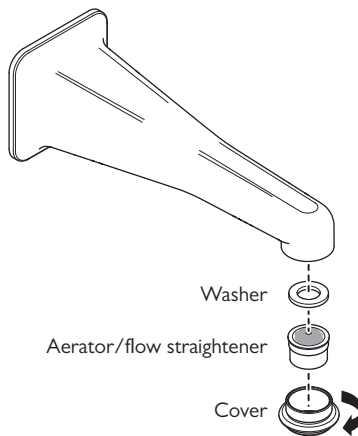

1 There is an aerator/flow straightener located in the end of the spout. To remove this unscrew and remove the cover.

2 The aerator/flow straightener can be cleaned in warm soapy water.

3 Assemble in the reverse order.

REPLACEMENT AERATORS/FLOW STRAIGHTENERS

Belle Aire Bath – PSH032

Classic Basin – PSH030

Classic Bath – None fitted

La Chapelle Basin – PSH034

La Chapelle Bath – PSH035

Janey Mac Basin – PSHI08

Janey Mac Bath – PSHI27

Mackintosh Basin – PSH029

Mackintosh Bath – PSH032

XO & TT Basin – PXT029

XO & TT Bath – PXT030



CONTRACT ENQUIRIES

+44 (0)1992 708 316

info@lefroybrooks.co.uk

CUSTOMER SERVICE, SPARES & TECHNICAL ENQUIRIES

+44 (0)1902 390 894

technical@lefroybrooks.co.uk

LEFROYBROOKS.CO.UK

Whilst every effort is made to ensure the accuracy of these, they are subject to change without notice as part of the company's product development process. The use of trademarks, product design and artwork is subject to licence or agreement with LBIP Ltd. The design registrations, trademark registrations and copyrights are protected by law and the use or reproduction outside the terms of an agreement is prohibited. The right to modify designs and dimensions is reserved. LBIP Ltd is a member of ACID (Anti Copying in Design). E&OE

½" BASIN WALL VALVES

INSTALLATION GUIDE

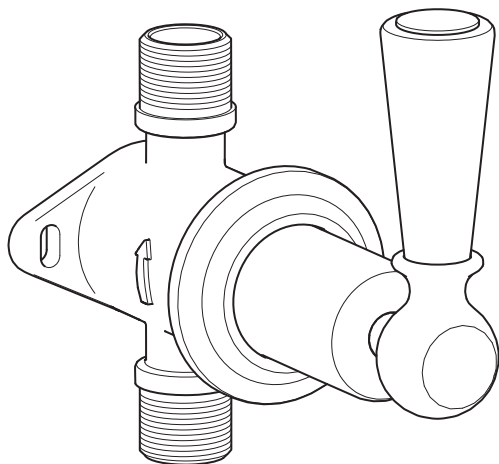

LEFROY BROOKS

IMPORTANT INFORMATION

Professional installation

We recommend that our products are fitted by a fully qualified professional plumber. They should be installed correctly and in accordance with all local water regulations and the system protected by non-return valves (not supplied). All products should be accessible for routine servicing.

Suits all systems

This Lefroy Brooks product is potentially suitable for every possible application, type of boiler and water supply pressure. However, if your supply pressure is below 1 bar it is advisable to fit a water pump. For systems with combination boilers, it is not advisable to fit pumps (refer to boiler manufacturer).

Supply temperature safety notice

A thermostatic mixing valve (TMV) should be fitted (not supplied) to the hot supply to restrict the temperature to a safe working/maximum temperature to comply with local building regulations, current legislation, relevant standards and codes of practice. Maximum allowed temperatures vary subject to type of installation or specification of building.

Flushing system

It is most important to flush out all pipework thoroughly before connecting the valve. This is the single most common cause of ceramic cartridge failure.

Supply connections

Lefroy Brooks do not supply any pipework or connections for wall valves as they can be installed in a variety of configurations subject to each customer's installation design or requirement.

Balancing flow

When using wall valves as separate hot and cold supplies, if a significant difference in pressure exists, we advise fitting a 'flow regulator' (not supplied) to the higher or both supplies. It is also recommended that non-return valves are fitted to protect your system (not supplied).

Connections

Connections should be made using ½" BSP female parallel connectors (not compression fittings)

Water quality

In hard water areas, a suitable water treatment system should be provided to prevent limescale deposits (calcium deposits) which may effect the long term performance of the ceramic cartridge. Exterior surfaces should be gently wiped with a dry soft cloth after use to minimise water stains and limescale deposits.

Servicing

All serviceable parts are available to maintain your Lefroy Brooks product.

EXTENSION KIT

A 25mm extension kit (part number WFV9900) is available for wall and flow valves that are fitted into deep walls. This consists of a shroud and spindle extension. The kit is available for all models except Belle Aire.

TYPICAL FLOW RATES

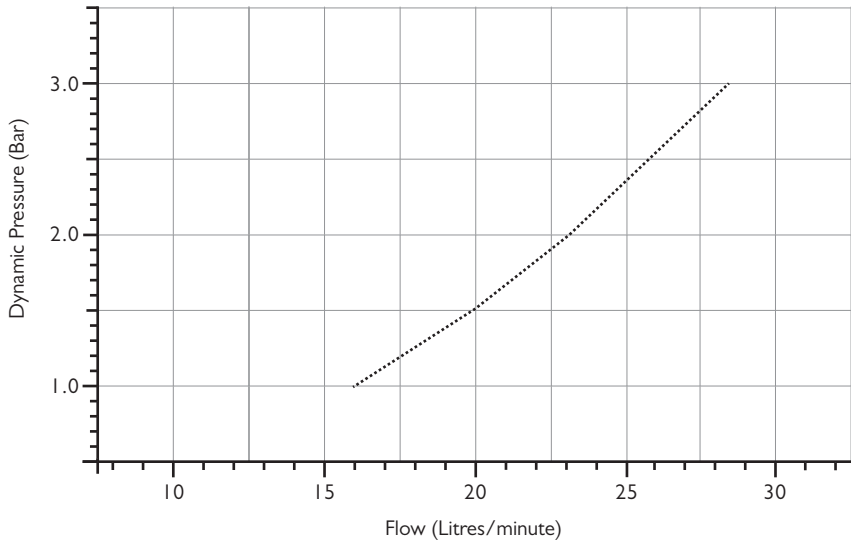

Note: The pressures shown are applied directly to the inlet; the flow rate indicated is free flowing and may vary subject to restrictions created by installation, pipework, layout or application.

WALL VALVE DIMENSIONS

Inlets and outlets have female 1/2" BSP parallel threads. All dimensions are in millimeters (mm).

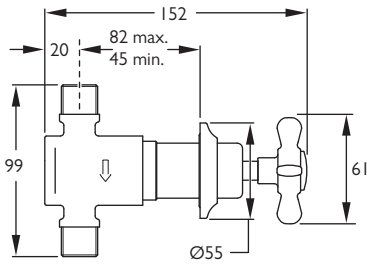

LB – Classic handwheel

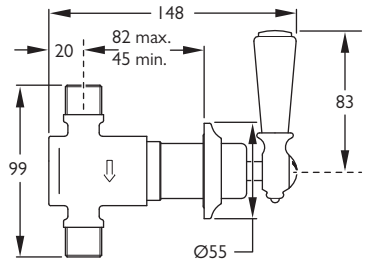

WL – White lever
BL – Black lever
MTL – Metal lever

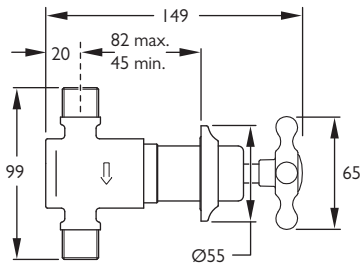

CH – Connaught handwheel

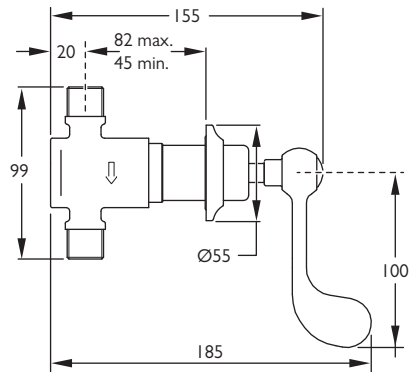

CL – Connaught lever
(available, but not offered as standard)

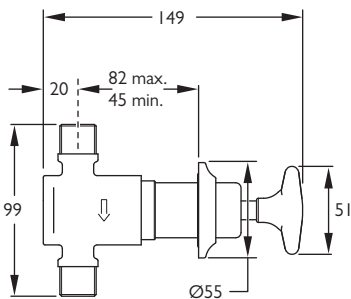

LS – Classic star handwheel

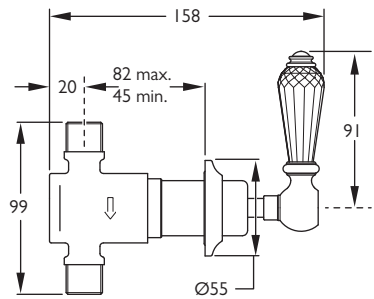

CR – Black crystal lever

Not to scale

Inlets and outlets have female 1/2" BSP parallel threads. All dimensions are in millimeters (mm).

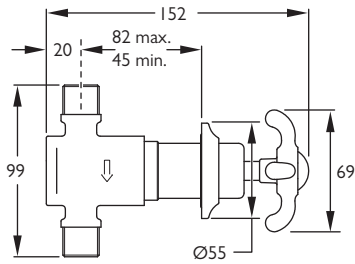

FH – La Chapelle handwheel

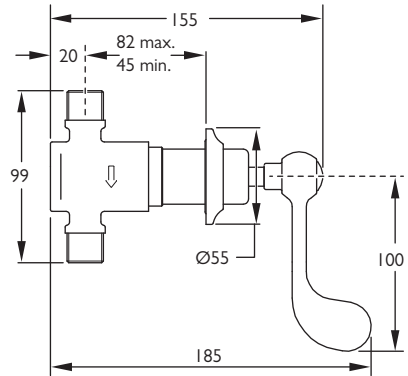

FL – La Chapelle lever
(available, but not offered as standard)

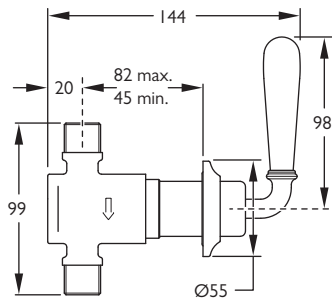

FW – La Chapelle white lever
FM – La Chapelle metal lever
FB – La Chapelle black lever

Inlets and outlets have female 1/2" BSP parallel threads. All dimensions are in millimeters (mm).

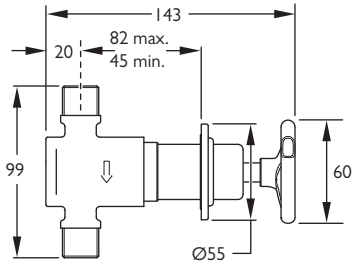

TH – Ten Ten handwheel

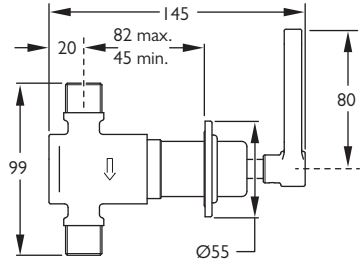

TL – Ten Ten lever

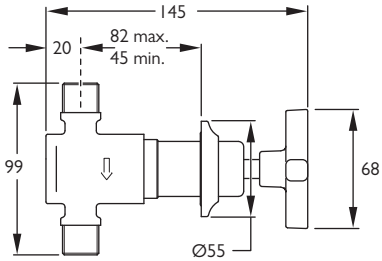

MH – Mackintosh handwheel

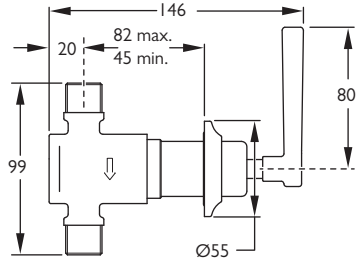

ML – Mackintosh lever
MB – Mackintosh black lever

Not to scale

Inlets and outlets have female 1/2" BSP parallel threads. All dimensions are in millimeters (mm).

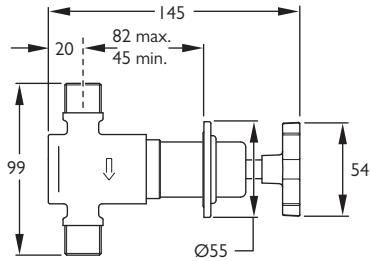

JH - Janey Mac handwheel

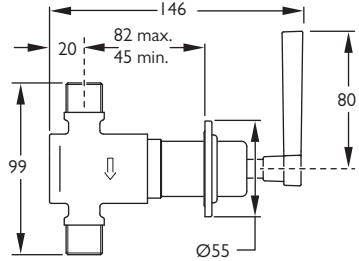

JL - Janey Mac lever

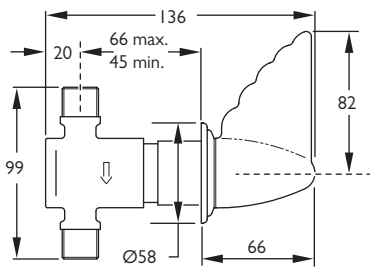

RH - Belle Aire handwheel

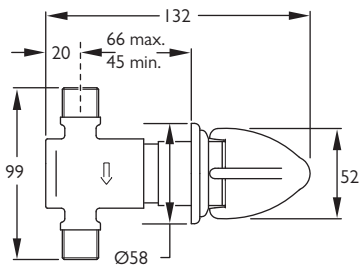

RL - Belle Aire handwheel

Not to scale

INSTALLATION

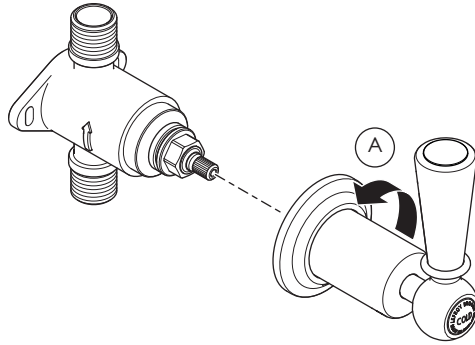

- 1 Unscrew and remove the shroud (A). Wearing a rubber glove such as those used for washing up will improve grip. The shroud forms part of the lever/cross handle/handwheel assembly. The wall plate will remain attached to the shroud.
- 2 Locate the valve body to the mounting surface and mark the locations of the mounting holes.
- 3 Drill the mounting surface to accommodate the chosen fixings.
- 4 The valve bodies have arrows indicating the direction of flow through the valve. Ensure that the arrows are in the required direction then secure in place using the required fixings.
- 5 Connect pipes to the valve inlet and outlet using suitable fittings to suit ½" BSP female parallel threads (NOT compression fittings such as nut and olive). Where soldered joints are used it is important to remove the flow cartridge from the valve body before applying heat to the valve body.
- 6 Rotate the splined end of the flow cartridge to the 'off' position. Locate and screw the shroud to the valve body.

REPLACEMENT PARTS

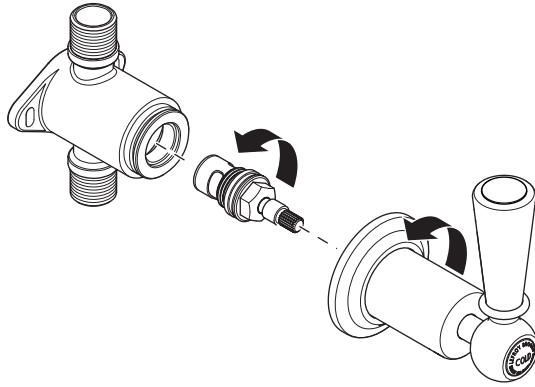

Spare cartridges (singles)

PWV015

½" x ½ turn clockwise closing ceramic cartridge for CH, FH, JH, LB, LS & MH handwheel models.

PWV016

½" x ¼ turn clockwise closing ceramic cartridge for BL, CL, CR, FB, FL, FM, FW, JL, MB, ML, MTL, TH, TL & WL lever models.

PHL065

½" x ¼ turn counter clockwise closing ceramic cartridge for BL, CL, CR, FB, FL, FM, FW, JL, MB, ML, MTL, TL & WL

PWV029

½" x ½ turn clockwise closing extended ceramic cartridge with adapter for RH handwheel models.

PWV025

½" x ¼ turn clockwise closing extended ceramic cartridge with adapter for RL lever models.

PWV026

½" x ¼ turn counter clockwise closing extended ceramic cartridge with adapter for RL lever models.



CONTRACT ENQUIRIES

+44 (0)1992 708 316

info@lefroybrooks.co.uk

CUSTOMER SERVICE, SPARES & TECHNICAL ENQUIRIES

+44 (0)1902 390 894

technical@lefroybrooks.co.uk

LEFROYBROOKS.CO.UK

Whilst every effort is made to ensure the accuracy of these, they are subject to change without notice as part of the company's product development process. The use of trademarks, product design and artwork is subject to licence or agreement with LBIP Ltd. The design registrations, trademark registrations and copyrights are protected by law and the use or reproduction outside the terms of an agreement is prohibited. The right to modify designs and dimensions is reserved. LBIP Ltd is a member of ACID (Anti Copying in Design). E&OE