

+

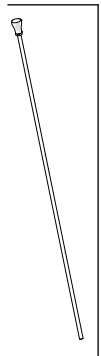

Not included / Non incluso / Non inclus / Nie zawarty / No incluido / Não incluido



C

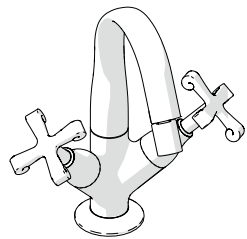

A



D



E

1

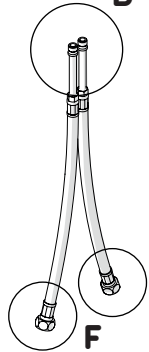

B

F

E

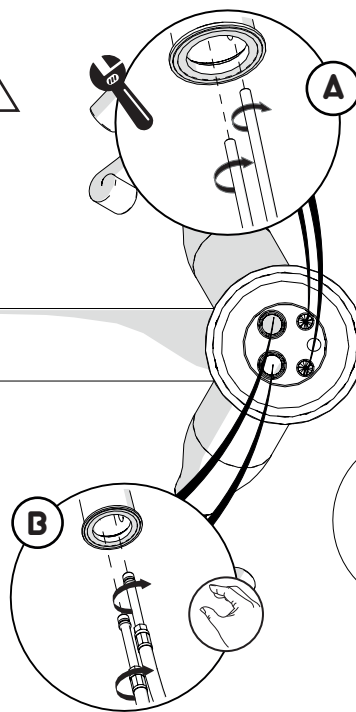
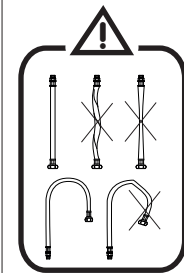
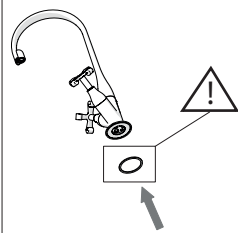

A

B

3

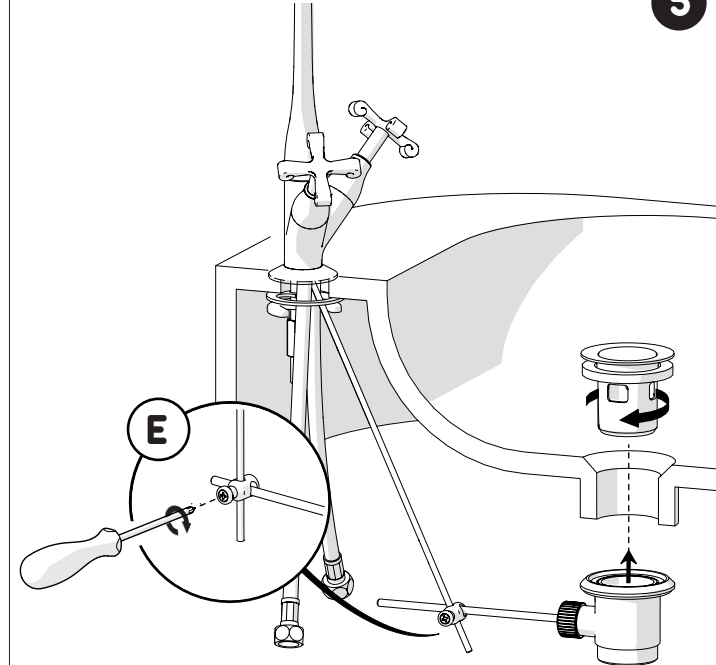

E

5

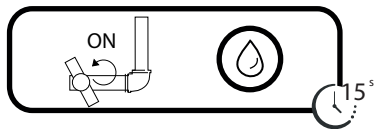

2

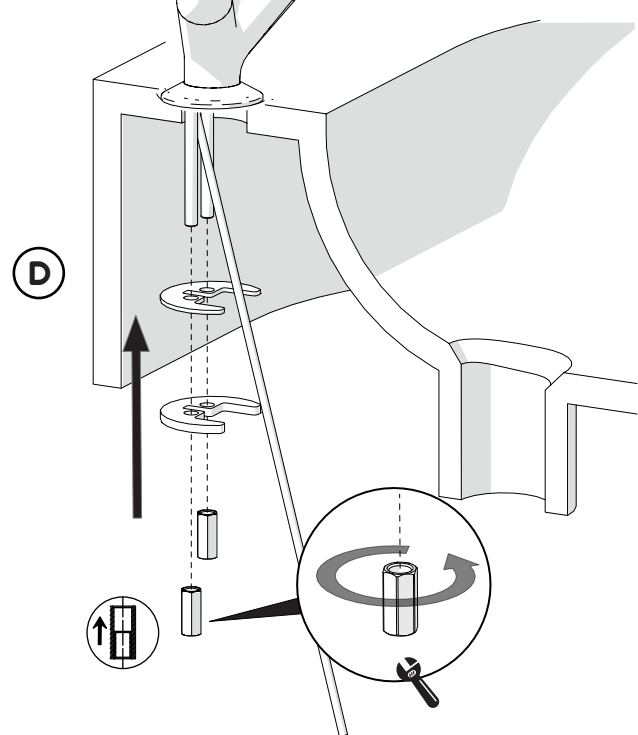
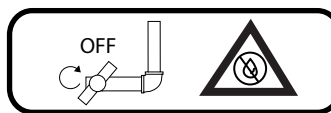
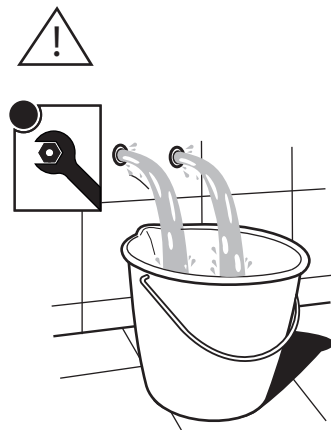

D

4

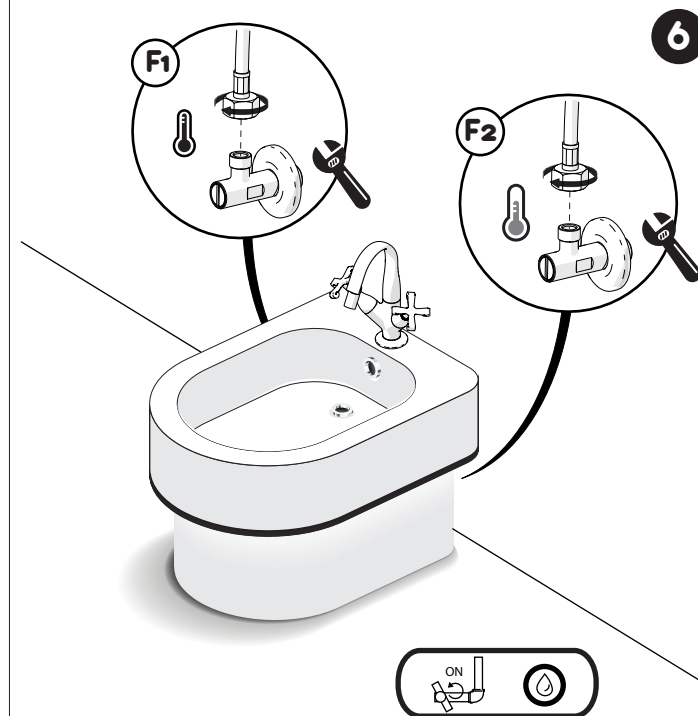

F1

F2

6

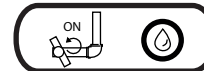

7

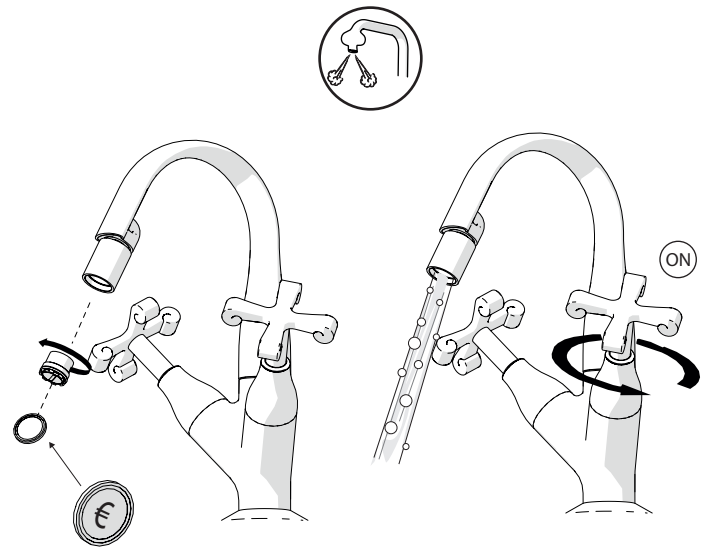

9

**CLEANING**

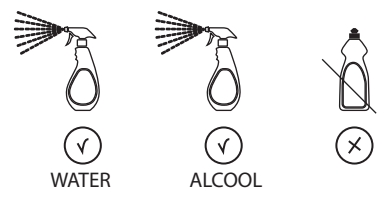
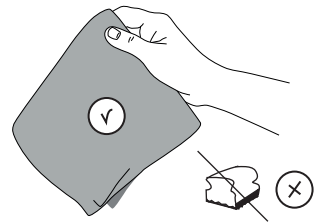

**NOBILIS®**  
The Best Technology for Water

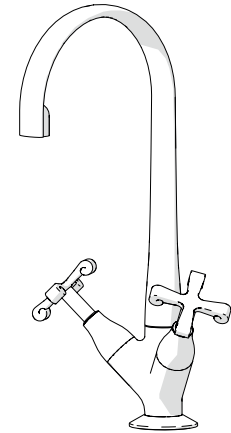

CP219/1

IISTRCP219/1--STD

[www.grupponobili.it](http://www.grupponobili.it)

REV1.06/2013

8

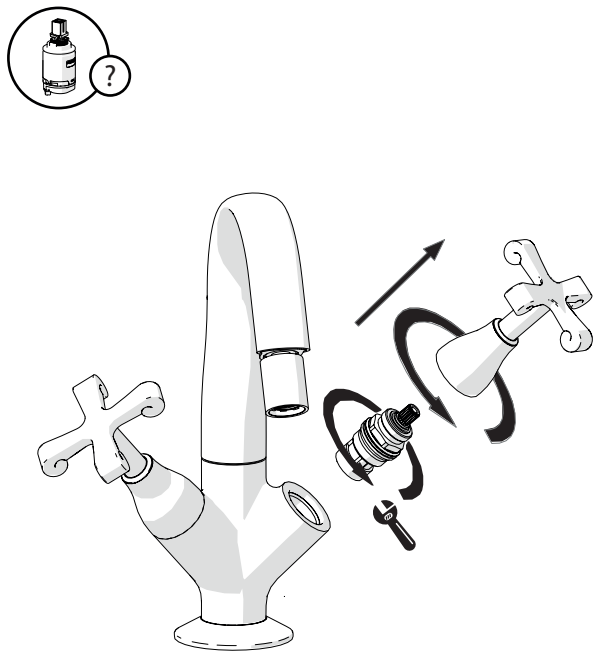

**NOBILIS®**  
The Best Technology for Water

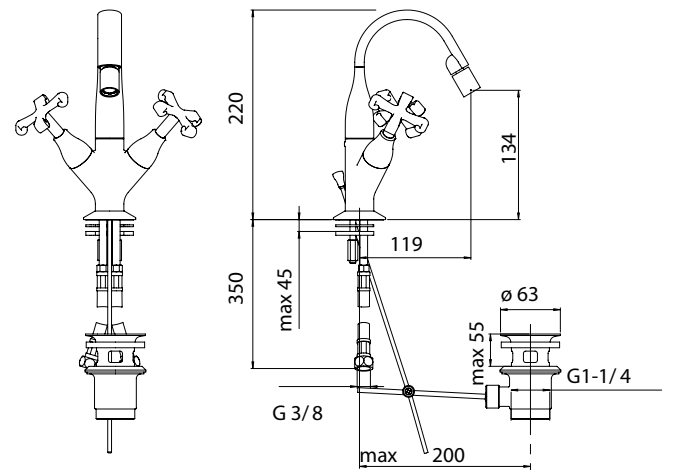

	<b>P</b>	P bar	0,5 MIN.		MAX 10		5		<b>T</b>	T °C		MAX 90		MIN 45
--	----------	-------	----------	--	--------	--	---	--	----------	------	--	--------	--	--------