

# NOBILI

LV0K133/EHT (KIT)  
LVUK0K133/EHT (KIT UK)

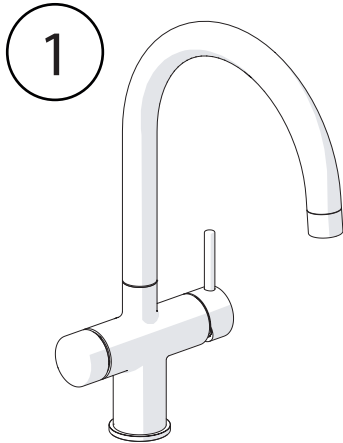

LV00133/EHT  
LV0K123/EHT (KIT)  
LVUK0K123/EHT (KIT UK)

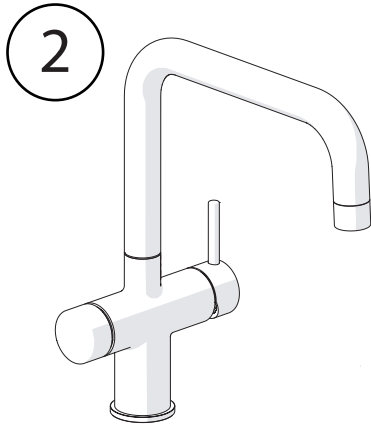

LV00123/EHT

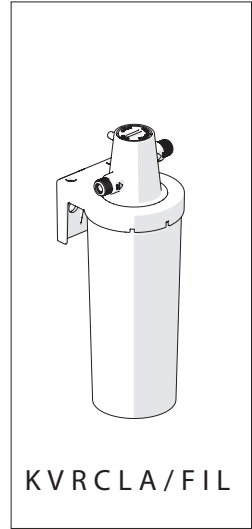

KVRCLA/FIL

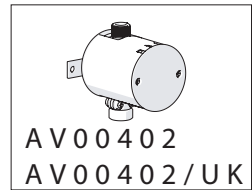

AV00402  
AV00402/UK

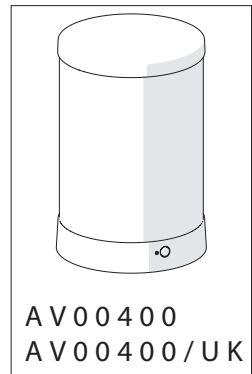

AV00400  
AV00400/UK



[www.nobili.it](http://www.nobili.it)

**NOBILI**  
SORGENTE





Not included / Non incluso

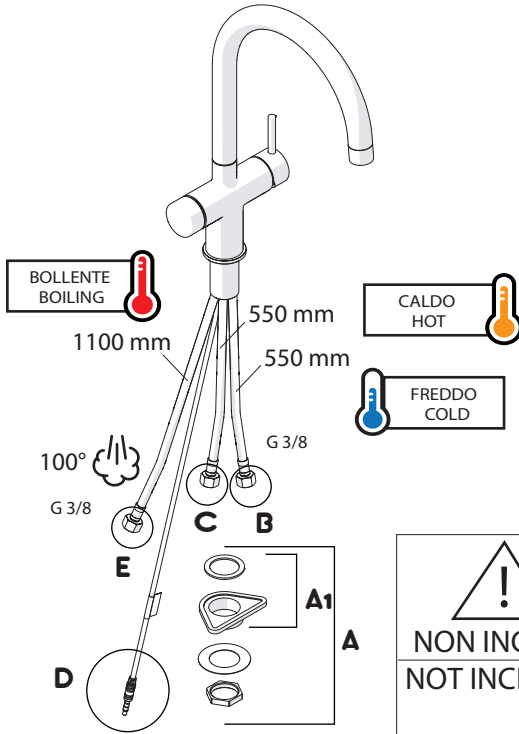
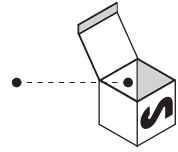
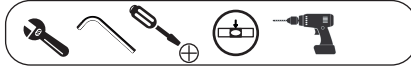

**PRIMA DI INIZIARE / BEFORE STARTING**

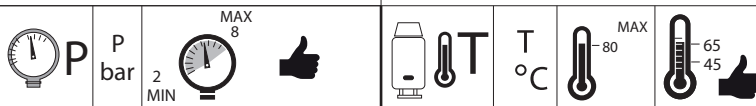

bar = 0.1 Mpa



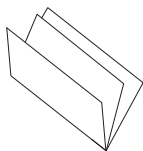

KVRCLA/FIL

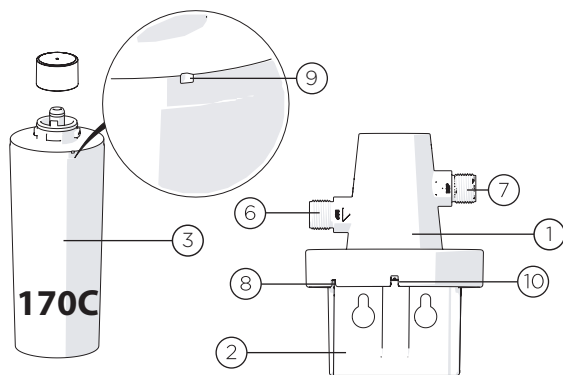
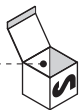

**Definizioni dei termini:**

- 1 Testa del filtro
- 2 Staffa di montaggio
- 3 Cartuccia filtrante
- 4 Indicatore del livello di miscelazione
- 5 Valvola di scarico/rilascio pressione
- 6 Ingresso
- 7 Uscita
- 8 Inserto contrassegno
- 9 Contrassegno della cartuccia del filtro
- 10 Contrassegno della posizione finale
- 11 Chiave impostazione miscelazione
- 12 Tubetto flessibile
- 13 Flessibile G3/8-G3/8 L=600mm
- 14 Tasselli

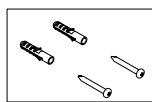
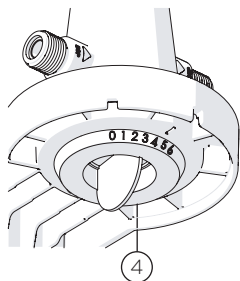

14

**Definitions of terms:**

- 1 Filter head
- 2 Mounting bracket
- 3 Filter cartridge
- 4 Blending level indicator
- 5 Flush/pressure release valve
- 6 Inlet
- 7 Outlet
- 8 Insert mark
- 9 Filter cartridge mark
- 10 End position mark
- 11 Blending setting key
- 12 Flexible tube
- 13 Flex G3/8-G3/8 L=600mm
- 14 Dowel

0 1 2 3 4 5 6

BYPASS

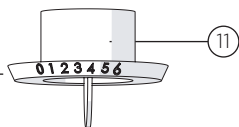

11

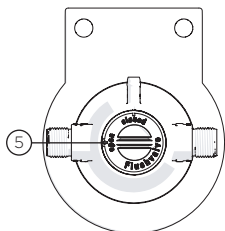

5

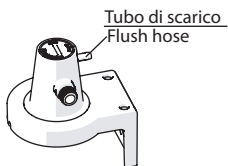

Tubo di scarico  
Flush hose

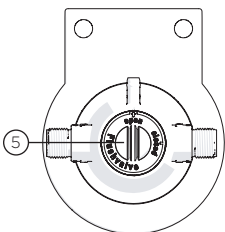

5

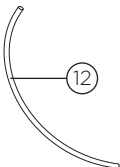

12

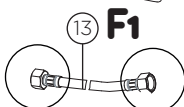

13

F1



NON INCLUSO  
NOT INCLUDE

AV00402  
AV00402/UK



G 3/8

SCATOLA IDRAULICA  
HYDRAULIC BOX

G 3/8

VELCRO  
FABRIC STICKER



GUARNIZIONE CON RETINA  
GASKET WITH MESH



GUARNIZIONE  
GASKET

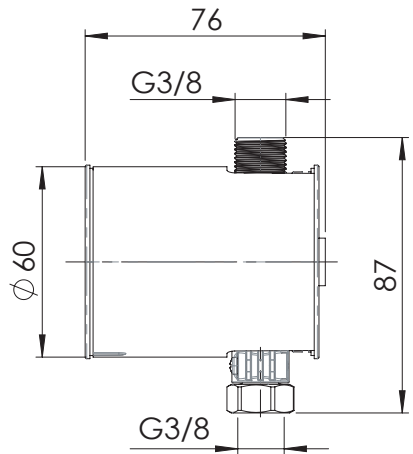
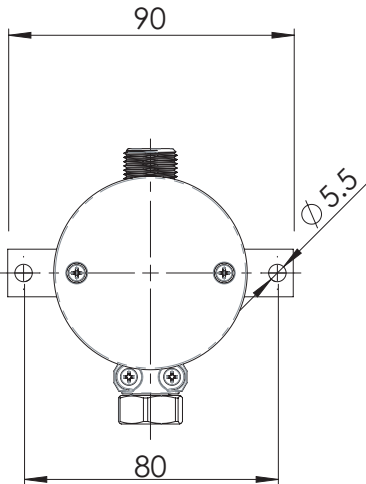
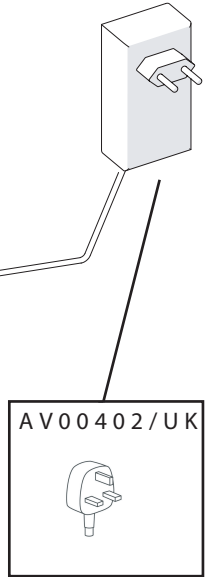

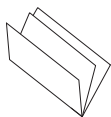

AV00400  
AV00400/UK

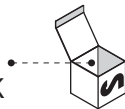

Raccordo a T  
T-piece



Guarnizione  
Gasket



CALDAIA  
BOILER

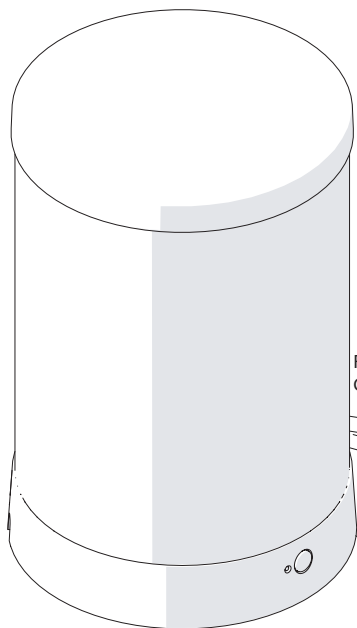

Fascetta  
Tie-wrap

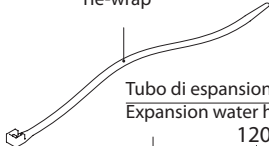

Scarico con giunto a T  
T-Joint drain

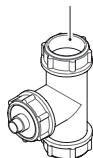

Tubo di espansione dell'acqua  
Expansion water hose  
1200 mm



Valvola di sicurezza flat in/out  
Safety valve flat in/out  
G 1/2



FLESSIBILE / FLEX 900 mm  
G 1/2

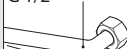

**F2**

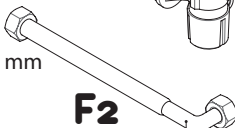

FLESSIBILE / FLEX 500 mm  
G 3/8 - G 1/2

FLESSIBILE / FLEX 430 mm  
G 3/8



AV00400/UK

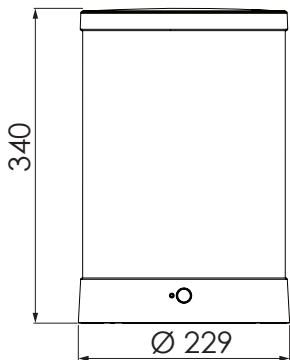

# INDICE

DATI TECNICI FILTRO .....	7-8
AVVERTENZE GENERALI DI INSTALLAZIONE E SICUREZZA FILTRO.....	9-10
DATI TECNICI CALDAIA.....	11-12
CLASSIFICAZIONE ENERGETICA E FUNZIONAMENTO CALDAIA.....	13-14
INSTALLAZIONE IDRAULICA.....	15-16
USO E STRUTTURA CARTUCCIA FILTRANTE.....	17
INSTALLAZIONE CARTUCCIA FILTRANTE.....	18
SOSTITUZIONE DELLA CARTUCCIA FILTRANTE.....	19
REGOLAZIONE BYPASS.....	19-20
INSTALLAZIONE IDRAULICA ATTACCO A MURO.....	21-22
DISEGNO TECNICI RUBINETTI.....	22
INSTALLAZIONE IDRAULICA COMPLETAMENTO.....	23
SCHEMA DI IMPIANTO COMPLETO.....	23-28
FUNZIONAMENTO CALDAIA PRIMA ACCENSIONE.....	29
FUNZIONAMENTO MANIGLIA DI EBOLLIZIONE.....	30-31
FUNZIONAMENTO MISCELATORE.....	32-33
SOSTITUZIONE CARTUCCE RUBINETTO.....	34
GRAFICI DI PORTATA.....	35
PERDITE D'ACQUA DELL'IMPIANTO.....	36
AVVERTENZE USO DELLA CALDAIA.....	37
RIPARAZIONI GUASTI CALDAIA.....	38-40
LA MANOPOLA ELETTRONICA NON RISPONDE.....	41
RIPARAZIONE GUASTI SISTEMA FILTRO.....	42
AVVERTENZE USO DEL RUBINETTO ACQUA BOLLENTE.....	43-44
SMALTIMENTO .....	45
OPTIONAL:CONTALITRI ELETTRONICO.....	46
NOTE-PULIZIA RUBINETTO.....	47
SCHEMA LED MANIGLIA-CERTIFICAZIONE CE-UKCA.....	48

# INDEX

TECHNICAL DATA FILTER .....	7-8
GENERAL FILTER INSTALLATION AND SAFETY WARNINGS .....	9-10
THECNICAL DATA BOILER.....	11-12
ENERGY CLASSIFICATION AND OPERATION BOILER.....	13-14
HYDRAULIC INSTALLATION .....	15-16
USE AND STRUCTURE OF THE FILTER CARTRIDGE .....	17
FILTER CARTRIDGE INSTALLATION .....	18
REPLACING THE FILTER CARTRIDGE .....	19
BYPASS ADJUSTMENT.....	19-20
HYDRAULIC INSTALLATION WITH WALL CONNECTION .....	21-22
TECHNICAL DRAWINGS TAPS.....	22
COMPLETE SETTING.....	23
HYDRAULIC INSTALLATION COMPLETE.....	23-28
OPERATION BOILER-SWITCHING ON FOR THE FIRST TIME.....	29
OPERATION BOILER HANDLE.....	30-31
MIXER OPERATION .....	32-33
CARTRIDGES REPLACEMENT TAP.....	34
FLOW CHARTS .....	35
SYSTEM WATER LEAKS.....	36
WARNINGS FOR USE OF THE BOILER.....	37
TROUBLESHOOTING BOILER SYSTEM.....	38-40
ELECTRONIC HANDLE NOT RESPONDE.....	41
TROUBLESHOOTING FILTER SYSTEM .....	42
WARNINGS USING THE TAP HOT WATER.....	43-44
DISPOSAL .....	45
OPTIONAL:ELETTRONIC LITER COUNTER.....	46
NOTE-CLEANING TAP .....	47
LED HANDLE SCHEME-CE-UKCA CERTIFICATION.....	48

## DATI TECNICI

Dimensioni	Unità	170
Volume interno filtro	l	0.9
Altezza del filtro+testa (A)	mm	295
Altezza del filtro (B)	mm	245
Diametro massimo della testa (C)	mm	100
Diametro massimo del filtro (D)	mm	95
Spazio di sostituzione del filtro (E)	mm	40
Peso	kg	0.9

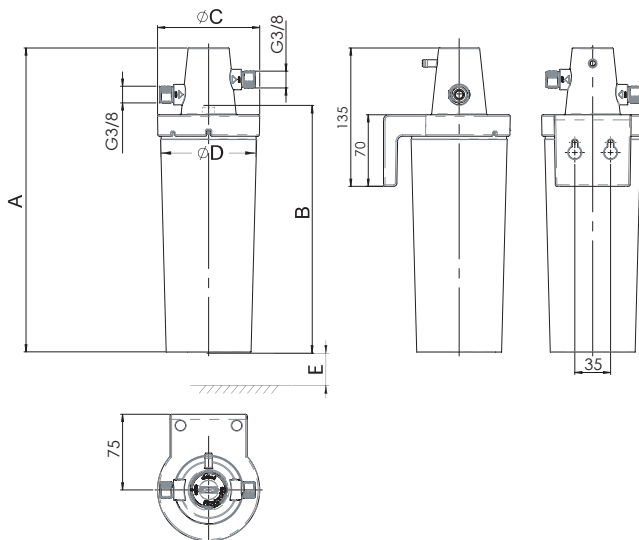

### Informazioni operative

Informazioni operative	Unità	170
Pressione di esercizio (senza sbalzi di pressione)		2-8 bar (29-116 psi)
Temperatura		4-30°C (39-86 °F)
Intervallo di flusso normale*	l/h	15-120
Portata con una caduta di pressione di 0.5 bar	l/h	>150
Posizione di installazione		verticale, orizzontale
Sistema bypass		7 settings (0-60%)

\*Per il consumo a breve termine è possibile una portata maggiore

Capacità (in l)	°dH*	°Clarke (GB)*	PPM*	°FH*	Bypass level	170
Lavello multifunzione (Acqua bollente)	10	13	179	18	6	1700

\*Durezza carbonatica

**Tutti i materiali utilizzati sono sicuri per il contatto con l'acqua potabile.**

# TECHNICAL DATA

Dimensions	Unit	170
Internal filter volume	l	0.9
Filter height incl. filter head (A)	mm	295
Filter height (B)	mm	245
Max. filter head diameter (C)	mm	100
Max. filter diameter (D)	mm	95
Space for filter replacement (E)	mm	40
Weight	kg	0.9

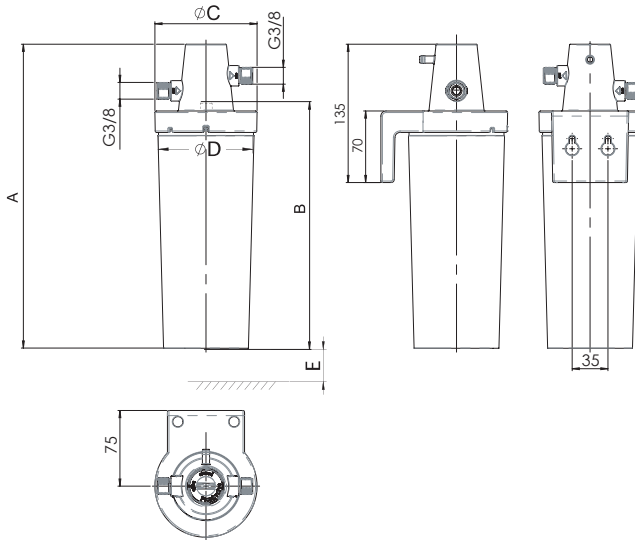

Operating information	Unit	170
Operating pressure (without pressure surges)		2-8 bar (29-116 psi)
Water temperature		4-30°C (39-86 °F)
Normal flow range*	l/h	15-120
Flow rate at a 0.5 bar drop in pressure	l/h	>150
Installation position		vertical, horizontal
Bypass system		7 settings (0-60%)

\*For short-term consumption, a higher flow rate is possible

Capacity (in l)	°dH*	°Clarke (GB)*	PPM*	°FH*	Bypass level	170
Multifunction sink (Boiling water)	10	13	179	18	6	1700

\*Carbonate hardness

**All of the materials used are safe for contact with drinking water.**



## AVVERTENZE GENERALI DI INSTALLAZIONE E SICUREZZA FILTRO

- Può essere utilizzata solo acqua fredda potabile per alimentare il sistema.
- Tutti i componenti devono essere conservati asciutti all'interno con limite di temperatura da -15° a 45° C (da 5 °F a 113 °F).
- L'impianto deve essere collocato in un luogo protetto dal gelo ed essere protetti dalla luce solare diretta.
- Il sistema non deve entrare in contatto prodotti chimici, solventi o altri vapori.
- La cartuccia del filtro non deve essere aperta o danneggiata.
- Se il filtro non viene utilizzato per più di 8 settimane, si consiglia di sostituirlo.
- Non utilizzare con acqua microbiologicamente non sicura o di qualità sconosciuta senza adeguata disinfezione prima o dopo l'impianto.
- Dopo 5 anni di utilizzo (al massimo 6 anni dopo la data di produzione) la testata del filtro e il montaggio a parete devono essere sostituiti (questo vale anche per tubi flessibili e guarnizioni). Controllare la data sul timbro di produzione.
- Dopo un lungo periodo di inattività o lavori di manutenzione sciacquare accuratamente il sistema. Vedere la tabella per il lavaggio del volume.

Volume di lavaggio dopo 1 settimana di inattività	Volume di lavaggio >2 settimane di inattività
2 litri (0.5 US gal)	10 liters (3 US gal)

### Istruzioni di installazione relative alla sicurezza

- La pressione dell'acqua all'ingresso del sistema di filtraggio non deve superare gli 8 bar (116 psi). È obbligatorio che un riduttore di pressione venga installato sul lato di alimentazione dell'acqua del filtro sistema se la pressione in ingresso supera 8 bar (116 psi).
- A monte deve essere installata una valvola di intercettazione per il sistema di filtraggio.
- Se a monte è installato un addolcitore, utilizzare filtro solo per acqua di rubinetto > 4° dH / 7° FH / 70 PPM di durezza totale.
- Tutti i componenti devono essere installati secondo linee guida specifiche per paese. Verificare la conformità con le leggi e i regolamenti statali e locali.
- Per l'installazione e funzionamento del sistema consigliamo le normative DIN 1988.
- Si consiglia di utilizzare solo accessori originali.
- Se la cartuccia viene rimossa dalla testa del filtro senza essere sostituita da una nuova, l'alimentazione alla testa del filtro deve essere interrotta.
- Non collegare alcun dispositivo alla valvola di scarico e/o tubo di lavaggio.

### ASSISTENZA/MANUTENZIONE

Un funzionamento affidabile del sistema può essere raggiunto solo se la cartuccia del filtro viene sostituita regolarmente. Il ciclo di sostituzione dipende dalla durezza della fornitura d'acqua, l'applicazione e il livello di bypass.

Consigliamo di sostituire la cartuccia del filtro dopo 6 mesi e non oltre 12 mesi a seconda sull'utilizzo. L'operatore si impegna a verificare la sistema per perdite ogni giorno. Quando la cartuccia del filtro viene sostituita, è necessario controllare tutte le parti impurità e danni. Le parti danneggiate devono essere sostituite o riparate.

## GENERAL FILTER INSTALLATION WARNINGS AND SAFETY

All components must be stored dry within a temperature limit of -15° to 45° C (5 °F to 113 °F)

- The system must be located in a frost-proof place and be protected from direct sunlight.
- The system must not come into contact with chemicals, solvents or other vapours.
- The filter cartridge must not be opened or damaged.
- If the filter is not used for more than 8 weeks, it is recommended to replace the filter cartridge.
- Do not use with water that is microbiologically unsafe or of unknown quality without adequate disinfection before or after the system.
- After 5 years of use (latest 6 years after production date) the filter head and wall mounting bracket must be replaced (this also applies to hoses and gaskets) – please check the date on the production stamp.
- After a longer downtime or maintenance works rinse the system thoroughly. See table for flush volume.

Flush volume after 1 week of stagnation	Flush volume >2 weeks of stagnation
2 liters (0.5 US gal)	10 liters (3 US gal)

### Safety-related installation instructions

- Water pressure at the filter system inlet must not exceed 8 bar (116 psi). A pressure reducer must be installed on the water supply side of the filter system if the inlet pressure exceeds 8 bar (116 psi).
- A shut-off valve must be installed upstream of the filter system.
- If a water softener is installed upstream, use filter only for tapwater > 4° dH / 7° FH / 70 PPM total hardness.
- All components must be installed according to country-specific guidelines. Check for compliance with state and local laws and regulations.
- DIN 1988 should be noted for installing and operating the system.
- We recommend only using genuine accessory hoses for the system.
- If the cartridge is removed from the filter head without being replaced by a new one, the water supply to the filter head must be shut off.
- Do not connect any devices to the flush valve and/or flush hose.

### SERVICE / MAINTENANCE

Reliable system function can only be achieved if the filter cartridge is replaced on a regular basis. The replacement cycle depends on the carbonate hardness of the water supply, the application and the bypass level.

We would recommend replacing the filter cartridge after 6 months and no later than 12 months depending on usage. The operator undertakes to check the system for leaks every day.

When the filter cartridge is replaced, all parts must be checked for impurities and damage. Damaged parts must be replaced and impurities remedied.

## DATI TECNICI CALDAIA

- Installato all'interno dell'armadio da cucina
- Set di installazione necessario per completare l'installazione
- Luce LED multicolore (stato, avviso e feedback)

Caldaia	4 litri
Dimensioni [H x L]	340 x 229 mm
Peso Netto	4.5 kg
Peso lordo	8.5 kg
Tensione	230 VAC
Potenza	2100 W (+5%/-10%)
Corrente	9.2 A
Standby modalità max.	14 W
IP classificazione	IPX4
Temperatura max	103°C
Tempo di riscaldamento [ $\Delta T$ 100 K]	15 min
Pressione di esercizio (max.)	800 kPa / 116 psi / 8 bar
Temperatura di esercizio:	0-40°C
Power supply EU:	Type E+F CEE 7/7 Schuko
Power supply UK:	Type G/ BS 1363 British 3 Pins

La caldaia viene fornita con un set di installazione.

Questo set di installazione, con valvola limitatrice di pressione (8 bar), è obbligatorio perché il sistema è pressurizzato.

Nelle regioni con una durezza dell'acqua  $>8$  °dH è necessario un filtro per proteggere il boiler dal calcare.

L'apparecchio deve essere sempre collegato all'alimentazione dell'acqua fredda.

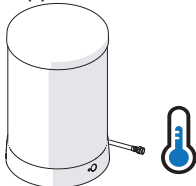

Prima dell'installazione della caldaia assicurarsi che l'uscita della valvola di massima pressione sia 8 cm sopra l'attacco del tubo di scarico.

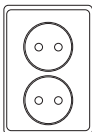

Installare 2 prese di corrente nelle vicinanze del Boiler.

## TECHNICAL DATA BOILER

- Installed within kitchen cabinet
- Installation set required to complete installation
- Multi-color light-LED (status, warning and feedback)

Boiler	4 liters
Dimensions [H x W]	340 x 229 mm
Net weight	4.5 kg
Full weight	8.5 kg
Voltage	230 VAC
Power	2100 W (+5%/-10%)
Load	9.2 A
Standby mode max.	14 W
IP classification	IPX4
Max temperature	103°C
Heating time [ $\Delta T$ 100 K]	15 min
Operating pressure (max.)	800 kPa / 116 psi / 8 bar
Operating temperature:	0-40°C
Power supply EU:	Type E+F CEE 7/7 Schuko
Power supply UK:	Type G/ BS 1363 British 3 Pins

The boiler is supplied with an installation set.

This installation set, with a pressure relief valve (8 bar) is obliged because the system is pressurized.

In regions with a water hardness  $>8$  °dH a Filter is necessary to protect the water heater from lime scale.

The appliance must be connected always with the cold water supply.

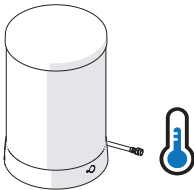

Before installation of the boiler make sure the pressure relieve valve outlet is 8 cm above the connection of the waste pipe.

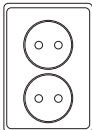

Install 2 sockets near the boiler.

## CONVENTIONAL WATER HEATER SCALDABAGNO CONVENZIONALE

PROFILO DI CARICO DICHIARATO E UTILIZZO TIPICO:  
DECLARED LOAD PROFILE AND TYPICAL USAGE:

XXS



CLASSE DI EFFICIENZA ENERGETICA RISCALDAMENTO ACQUA:  
WATER HEATING ENERGY EFFICIENCY CLASS:

A

% DI EFFICIENZA ENERGETICA RISCALDAMENTO ACQUA:  
% WATER HEATING ENERGY EFFICIENCY :

35,15 %

CONSUMO ANNUO DI ENERGIA ELETTRICA:  
ANNUAL ELECTRICITY CONSUMPTION :

523(EU)-520(UK)KWh

LIVELLO DI POTENZA SONORA ALL'INTERNO:  
SOUND POWER LEVEL INDOORS :

15 dB

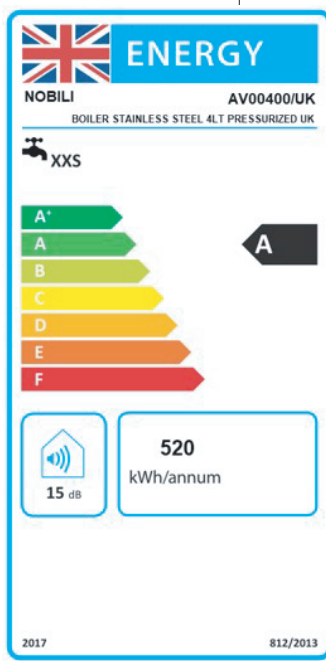
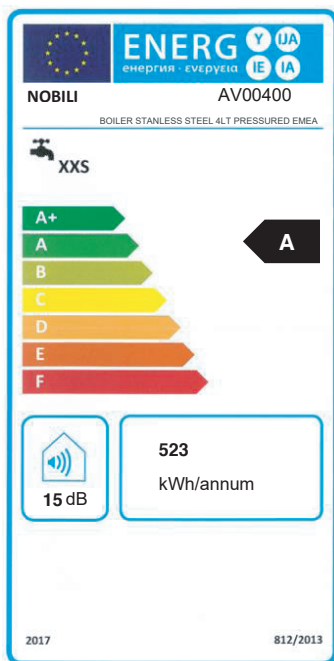

## FUNZIONAMENTO CALDAIA

Premere brevemente il pulsante ON/STANDBY commuta tra le modalità caldaia ON e STAND-BY.

Indicazioni LED

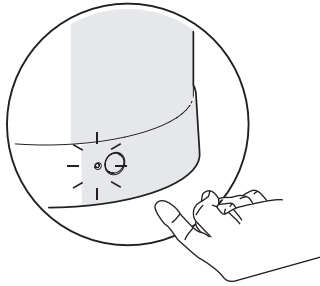

Colore		Messaggio
Blu		Controllo del sistema completo
Rosso lampeggiante		Processo di riscaldamento
Rosso		Processo di riscaldamento terminato (15 min)

ACCESO:

- L'acqua della caldaia viene riscaldata continuamente fino a quando si raggiungono i 103°C.



## OPERATION BOILER

Briefly pressing the ON/STANDBY button switches between the boiler modes ON and STANDBY.

LED indications

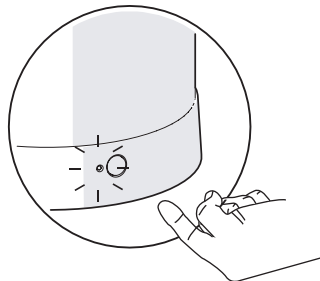

Color		Message
Blue		Commissioning, system self - check
Red flashing		Heating process
Red		Heating process finished (15 min)

ON:

- The boiler water is heated continuously until the 103 °C is reached.



# INSTALLAZIONE IDRAULICA

## HYDRAULIC INSTALLATION

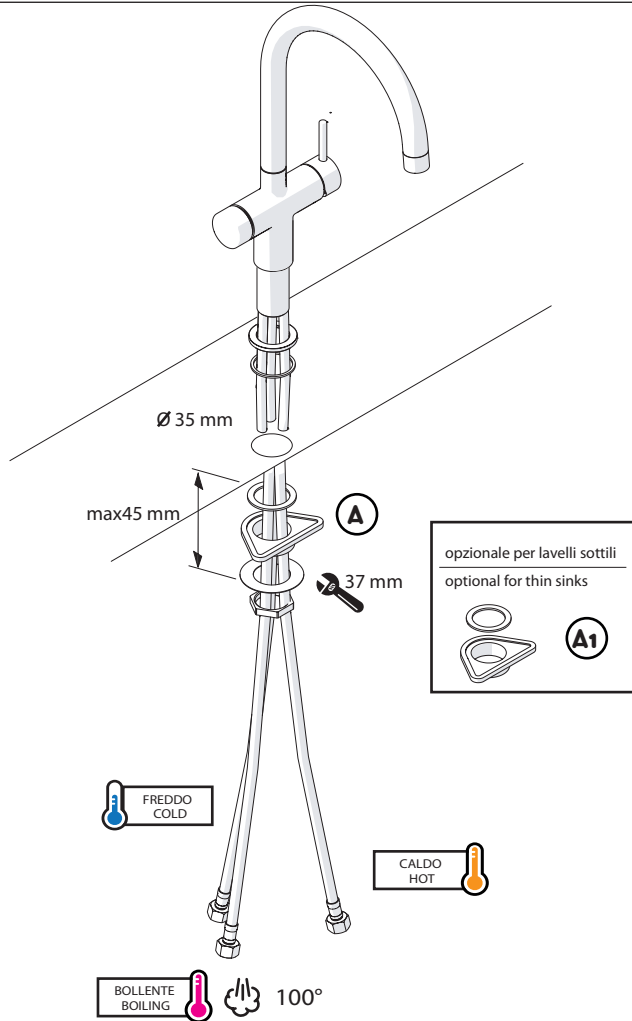
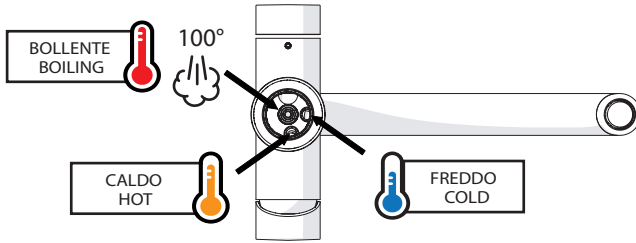

RUBINETTO  
TAP

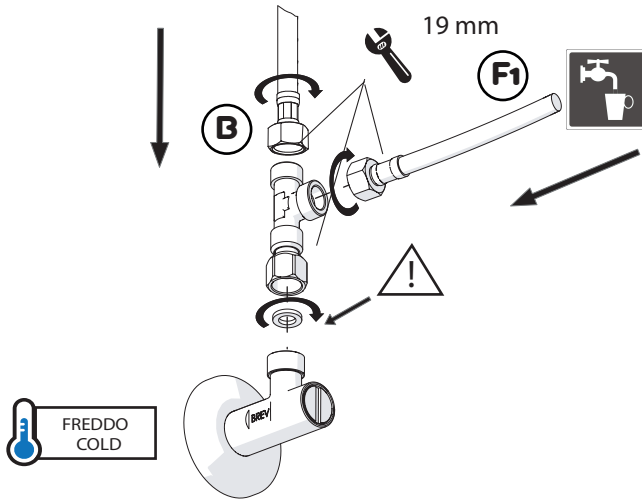

RUBINETTO  
TAP

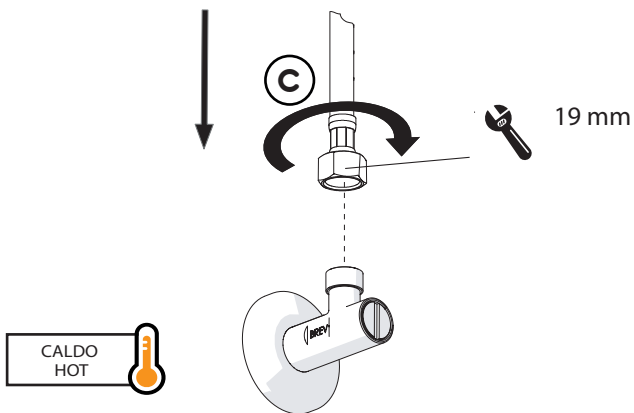



## USO E STRUTTURA CARTUCCIA FILTRANTE

### **Filtri antiparticolato**

I tessuti filtranti appositamente selezionati trattengono sporco e particelle, fornendo così una protezione duratura del filtro anche in caso di acqua di scarsa qualità .

### **Carbone attivo**

Grazie alla loro enorme superficie, i componenti in carbonio si attivano e sono in grado di rimuovere elementi indesiderati come cloro e contaminanti organici ed eliminano gli odori sgradevoli.

### **Filtri fini e microplastici**

Moduli di carbon block e microfiltrazione attivi rimuovono efficacemente anche le particelle più piccole e impurità. Allo stesso tempo, formano una seconda linea di difesa per trattenere i contaminanti organici.

### **Scambiatori di ioni**

Gli scambiatori di ioni riducono la durezza dell'acqua e quindi prevengono depositi di calcare. Inoltre, riducono il peso tossico di metalli come il piombo.

### **Stabilizzazione minerale**

Minerali preziosi come calcio e magnesio sono parzialmente trattenuti. Calcio, che forma calcare, si converte in una forma solubile dal nostro stabilizzazione minerale con tecnologia brevettata per prevenire depositi di calcare.

## USE AND DESIGN FILTER CARTRIDGE

### **Particle filters**

Specially selected filter fleeces hold back dirt and particles, thus providing lasting filter protection even when water quality is poor.

### **Activated carbon**

Thanks to their enormous surface area, our activated carbon components are able to remove undesired substances such as chlorine and organic contaminants and they eliminate unpleasant odors.

### **Fine and microplastic filters**

Active carbon block and microfiltration modules efficiently remove even the smallest particles and impurities. At the same time, they form a second line of defense for holding back organic contaminants.

### **Ion exchangers**

Ion exchangers reduce water hardness and thus prevent limescale deposits. In addition, ion exchangers reduce toxic heavy metals such as lead.

### **Mineral stabilization**

Valuable minerals such as calcium and magnesium are partially retained. Calcium, which forms limescale, is converted into a soluble form by our patented mineral stabilization technology in order to prevent limescale deposits.

**Installazione della testata del filtro/staffa di montaggio / Cartuccia filtrante**  
**Installation of filter head / Mounting bracket / Filter cartridge**

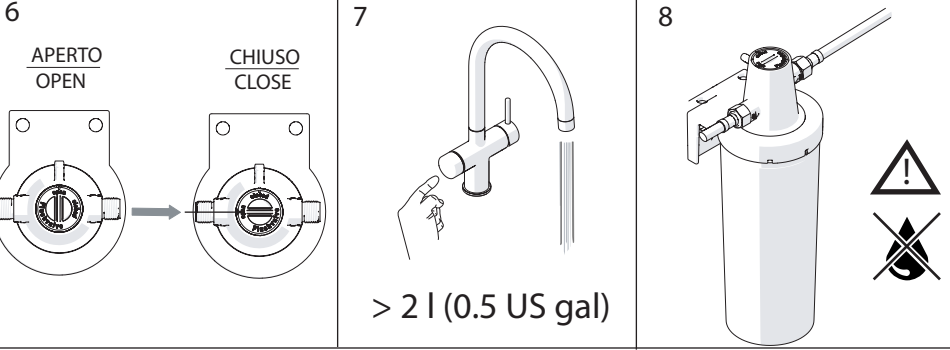
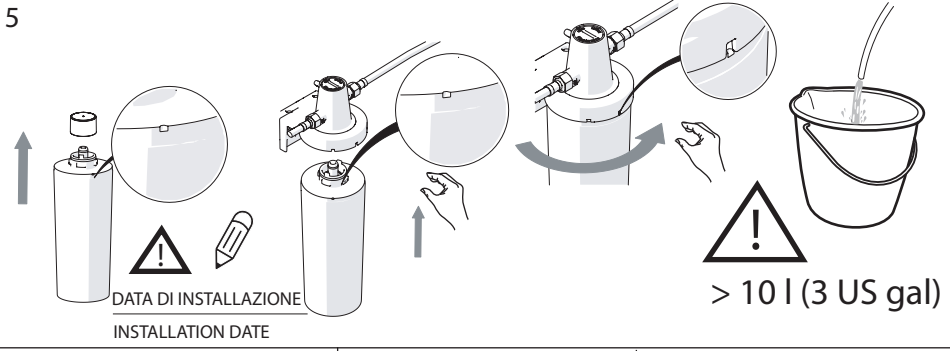
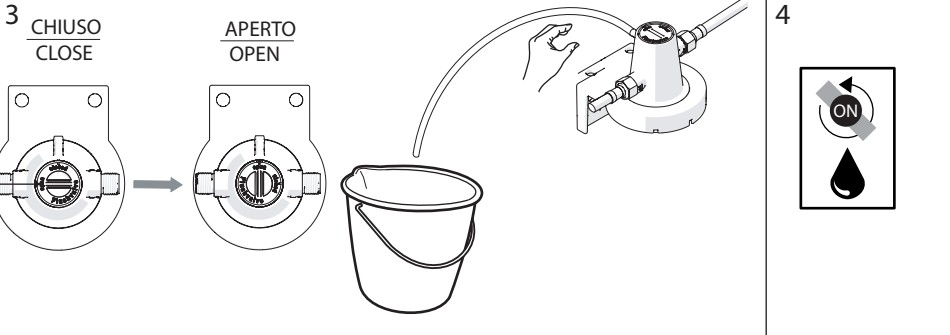
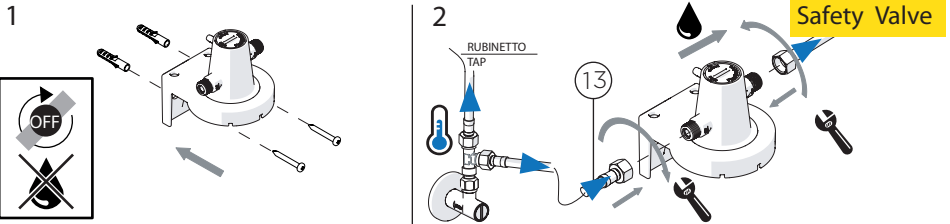

**Sostituzione di una cartuccia filtrante**  
**Replacing a filter cartridge**

1

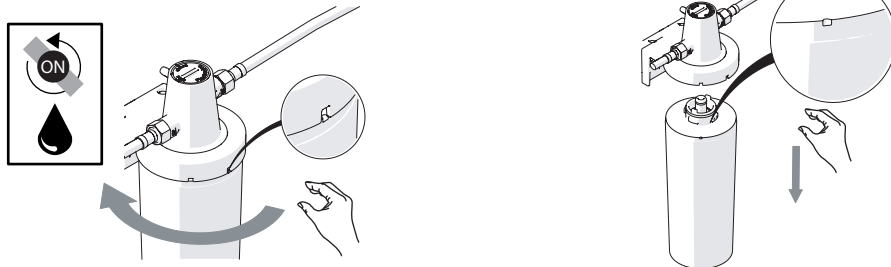

2

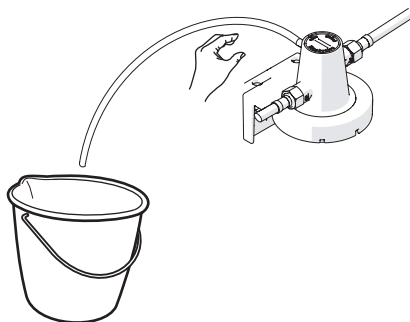
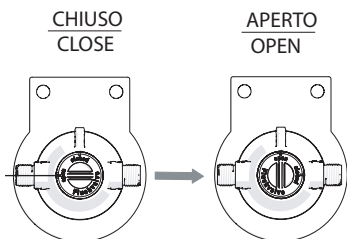

3

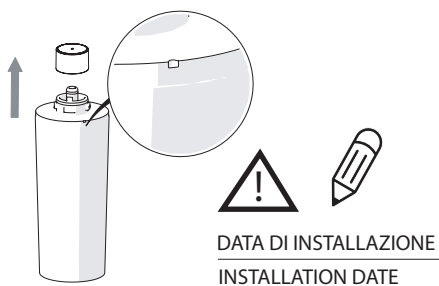

4

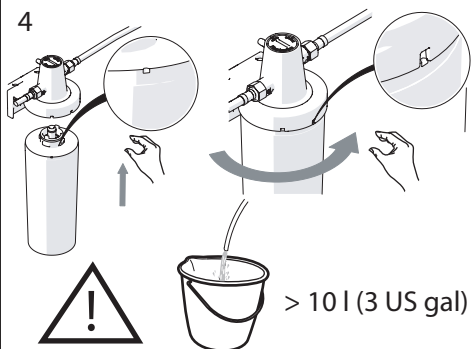

5

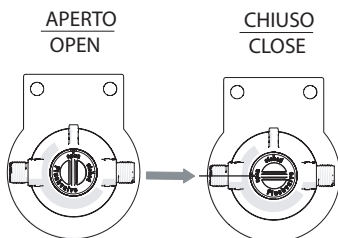

6

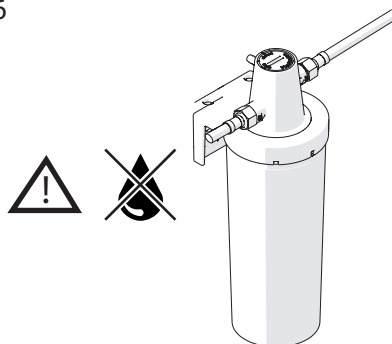

## REGOLAZIONE BYPASS

### **Determinazione della durezza carbonatica**

Utilizzare un kit di test per determinare la durezza nella fornitura d'acqua. Per compensare le fluttuazioni della qualità dell'acqua di alimentazione ed errori di misurazione del kit test si consiglia di aggiungere 2° KH / 2° Clarke / 30 PPM / 3° FH al valore determinato. Usa questo valore per determinare il livello di bypass e per la determinazione della capacità del filtro.

### **Impostazione della miscela (BYPASS)**

L'esclusiva tecnologia della valvola di bypass DuoBlend® consente una regolazione precisa della durezza carbonatica nell'acqua filtrata. È possibile regolare il livello di bypass per adattarsi al meglio al tipo di apparecchio e applicazione, ovvero ai lavelli multifunzione (acqua bollente).

Per regolare il livello di bypass (4) premere verso il basso la chiave di impostazione bypass (11) e girare il disco DuoBlend® (4) al livello specificato nella apposita tabella (pagina 21). Dopo aver posizionato la miscelazione bypass del disco del DuoBlend® al livello specificato, rimuovere la chiave di regolazione (11) e conservarla per i futuri ripristini .

### **Determinazione della capacità del filtro**

In base al livello di durezza carbonatica dell'acqua di alimentazione e all'applicazione, utilizzare la tabella (pagina 21) per individuare il bypass consigliato come impostazione e la capacità risultante della cartuccia del filtro.

Si prega di segnare la data di installazione sull'etichetta della cartuccia.

## BYPASS ADJUSTMENT

### **Determining the carbonate hardness**

Use the corresponding test kit to determine the carbonate hardness in the water supply. In order to compensate for fluctuations in the quality of feed water and measuring errors of the test kit we recommend to add 2° KH / 2° Clarke / 30 PPM / 3° FH to the value determined. Use this value to determine the recommended bypass level setting and for the determination of the filter capacity.

### **Blend setting (BYPASS)**

The unique DuoBlend® bypass valve technology enables precise adjustment of carbonate hardness in the filtered water. It is possible to adjust the bypass level to best suit the appliance type and application, in this case hot drinks with steam multifunction sink (boiling water).

To adjust the bypass level (4) press down the bypass setting key (11) and turn the DuoBlend® bypass blending disc (4) to the level specified in the appropriate table (page 21).

After positioning the DuoBlend® bypass blending disc to the specified level, remove the bypass setting key (11) and hold in safekeeping for possible future DuoBlend® bypass resettings.

### **Determining the filter capacity**

Based on the carbonate hardness level of the water supply and your application, use the table in (page 21) to identify the recommended bypass setting and the resultant filter cartridge capacity.

Please mark the installation date in the corresponding boxes on the cartridge label.

## Lavelli multifunzione (acqua bollente)/Multifunction sink (Boiling water)

°dF	°dH*	ppm*	Bypass	170C
<7	<4	70	6	3920
9	5	89	6	3220
11	6	107	6	2830
13	7	125	6	2430
14	8	143	6	2130
16	9	161	6	1890
18	10	179	6	1700
20	11	196	6	1550
21	12	214	6	1280
23	13	232	6	1180
25	14	250	6	1090
27	15	268	6	1020
29	16	286	6	960
30	17	304	6	900
34	19	339	6	810
38	21	375	6	730
41	23	411	6	670
47	26	464	5	500
52	29	518	5	440
59	33	589	5	370

°dF = gradi di durezza francesi    °dH = gradi di durezza tedeschi

°dF = French hardness levels    °dH = German hardness levels

## INSTALLAZIONE IDRAULICA ATTACCO A MURO HYDRAULIC INSTALLATION WITH WALL CONNECTION

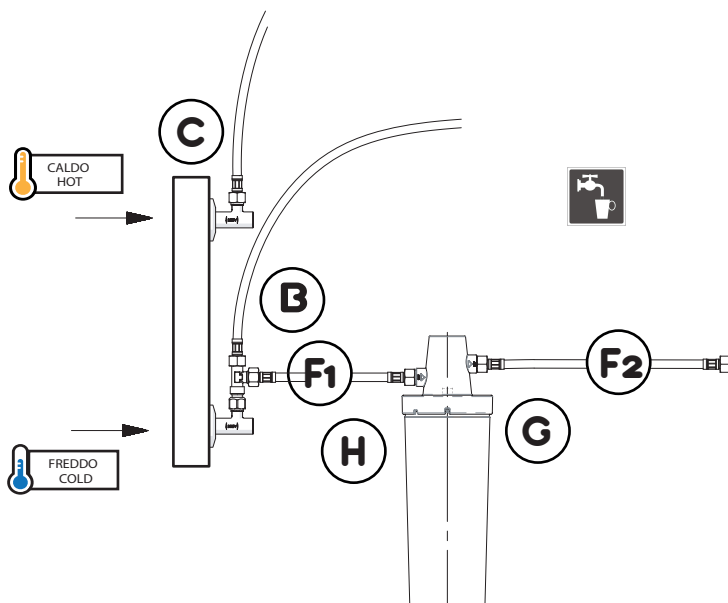

DISEGNO TECNICO  
TECHNICAL DRAWING

1

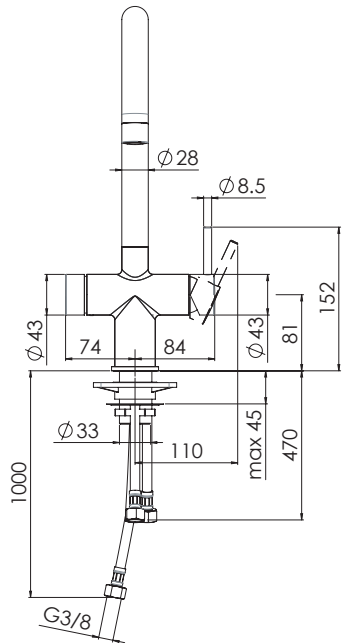
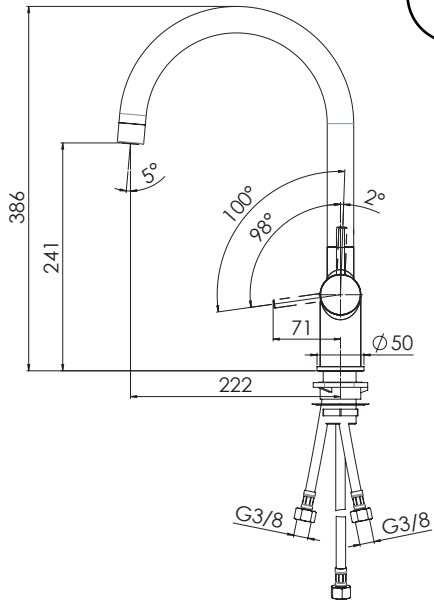

2

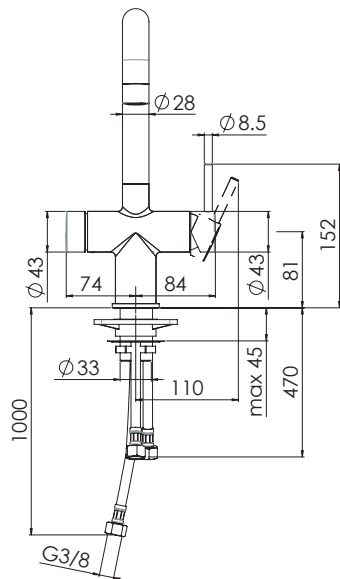
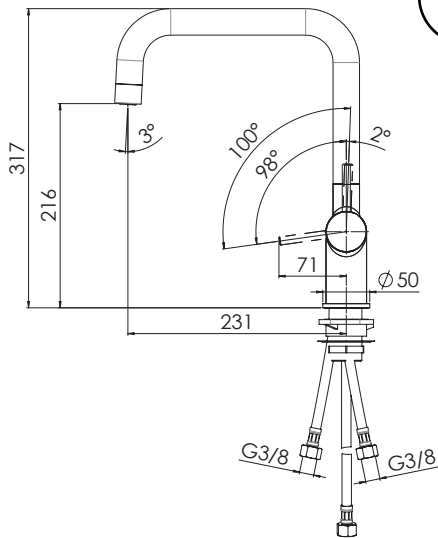

# INSTALLAZIONE IDRAULICA COMPLETAMENTO

## HYDRAULIC INSTALLATION COMPLETE

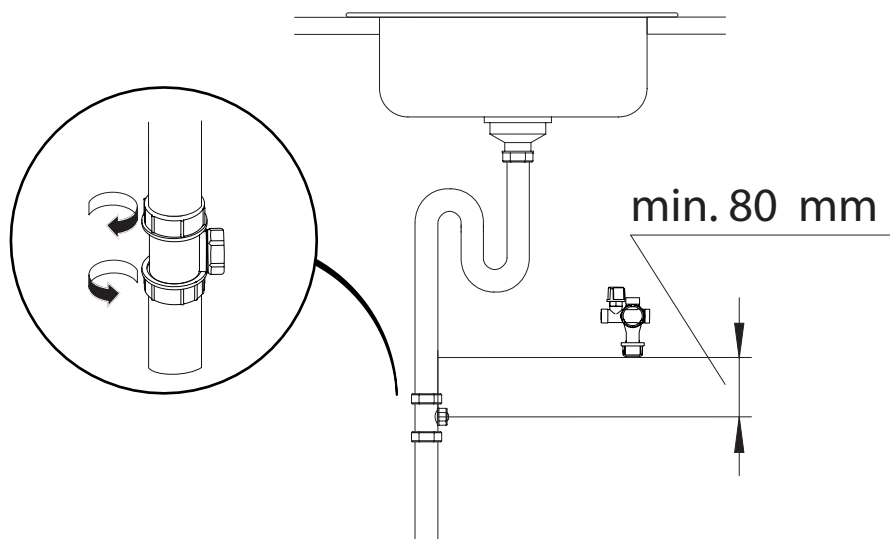
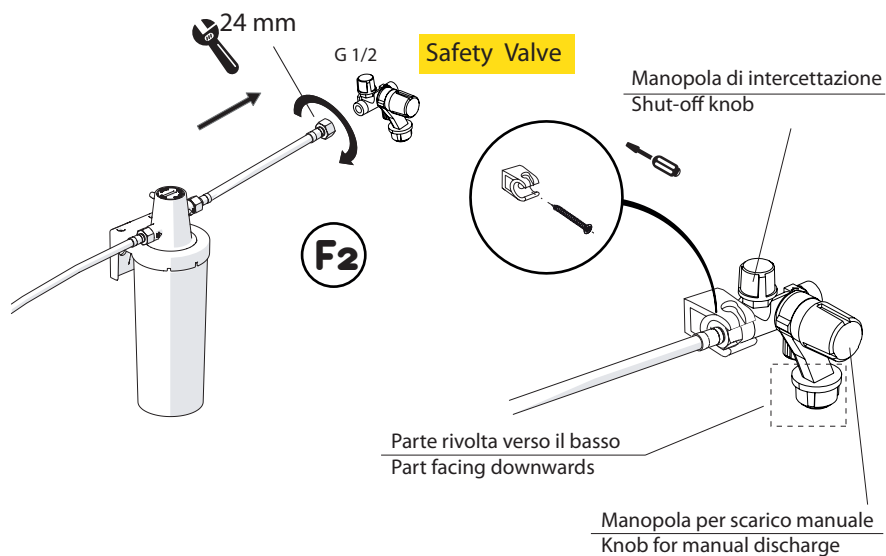

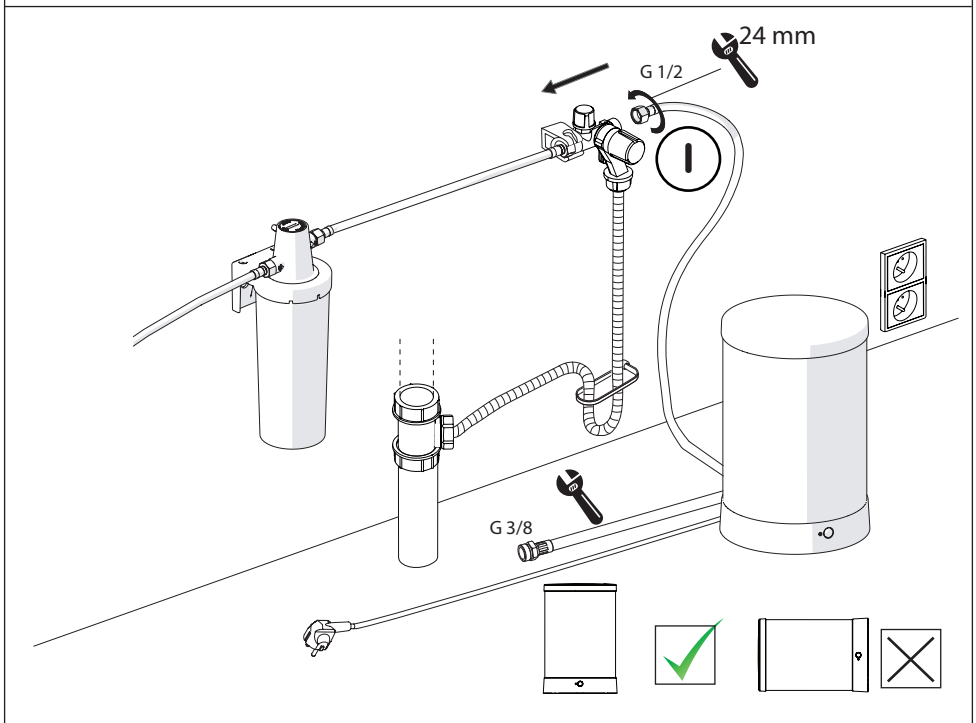
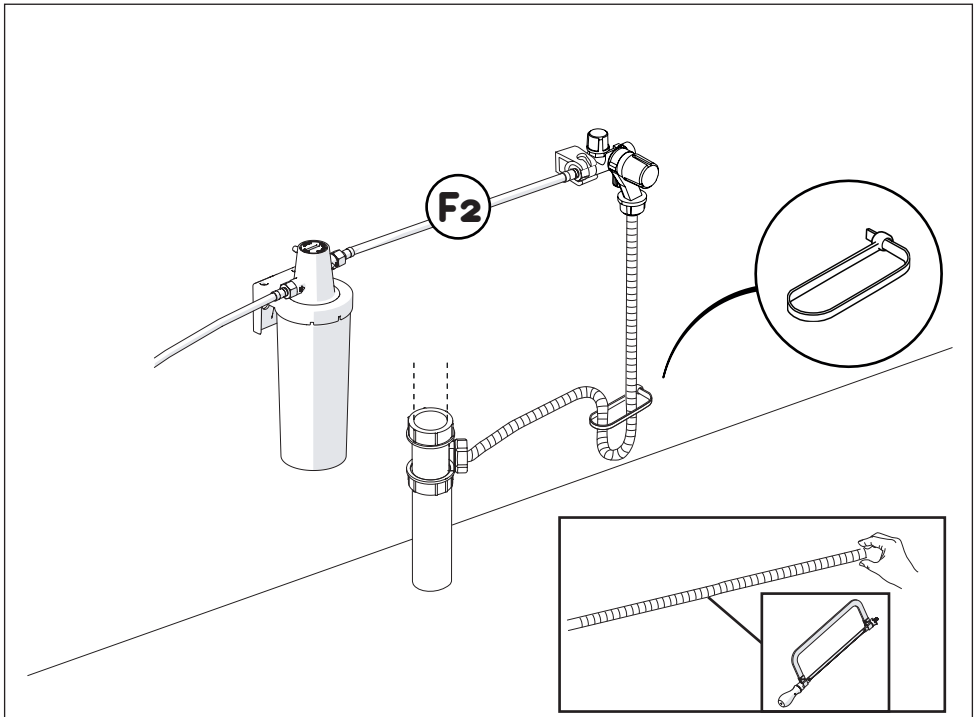



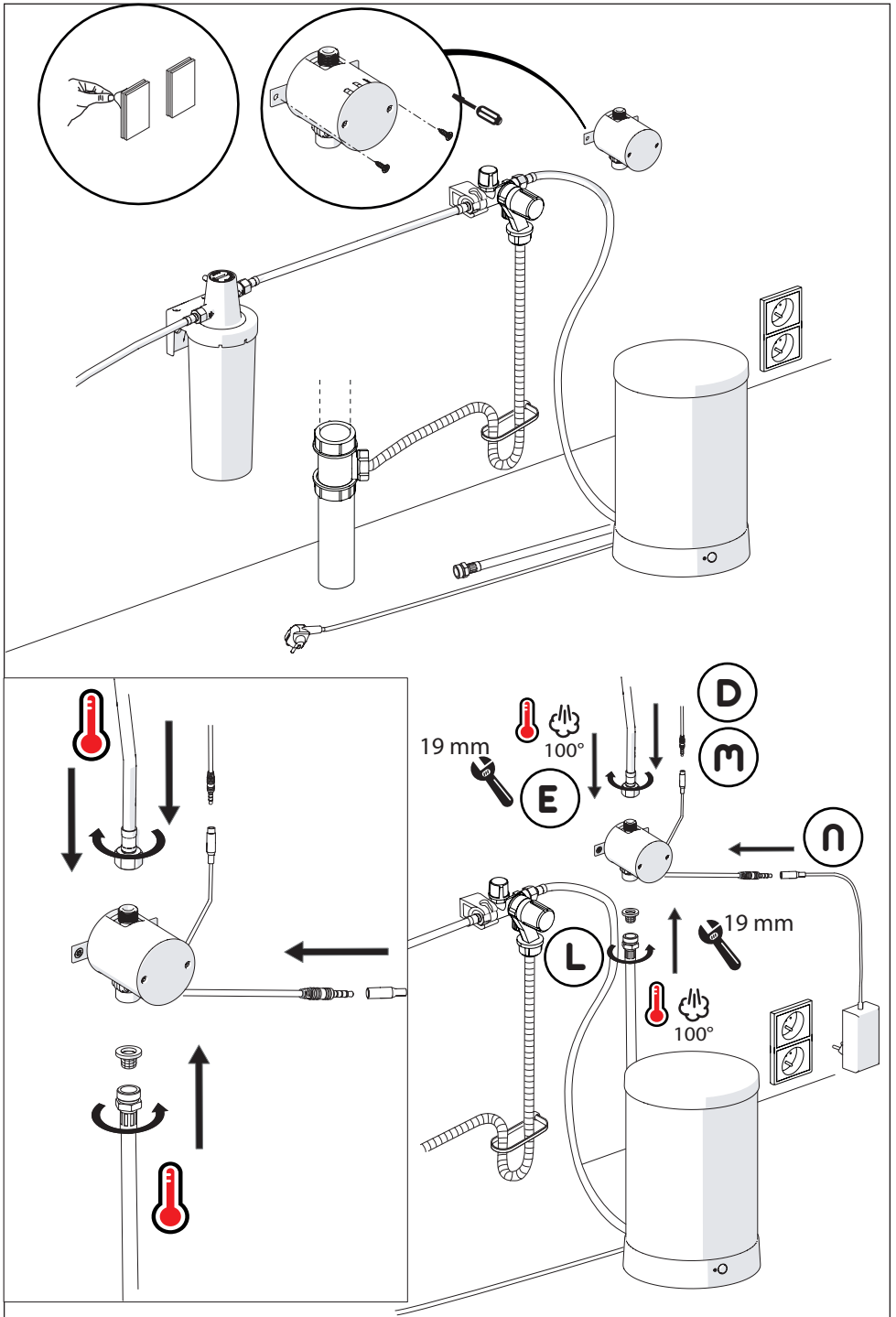



Aprire la valvola di ritegno/intercettazione e controllare che il sistema non presenti perdite.  
Open the check/shut off valve and check the system for leaks.

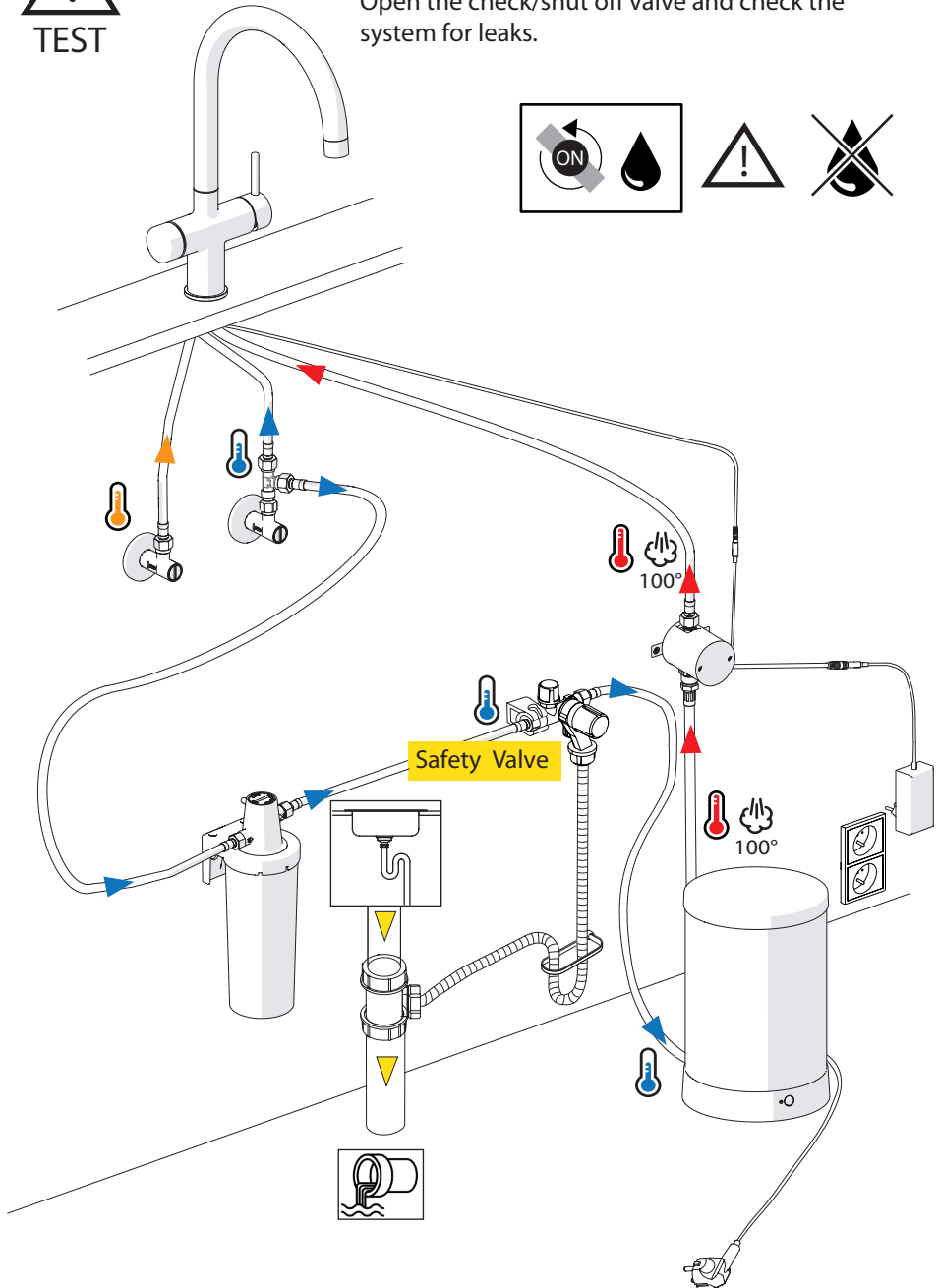
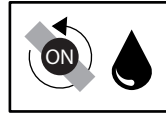

# SCHEMA IMPIANTO SETTING

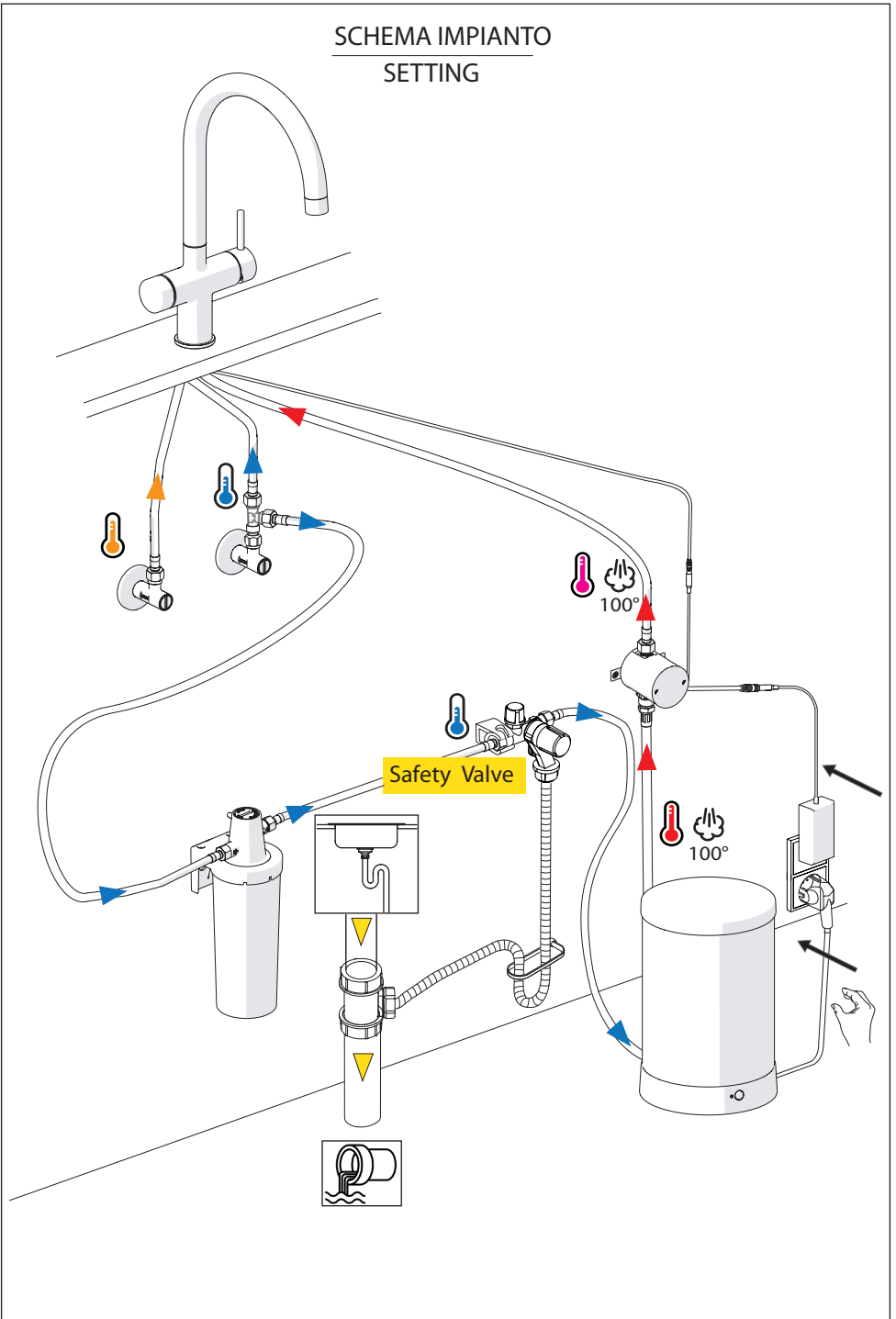

ESEMPIO DI CONFIGURAZIONE DI INSTALLAZIONE  
INSTALLATION CONFIGURATION EXAMPLE

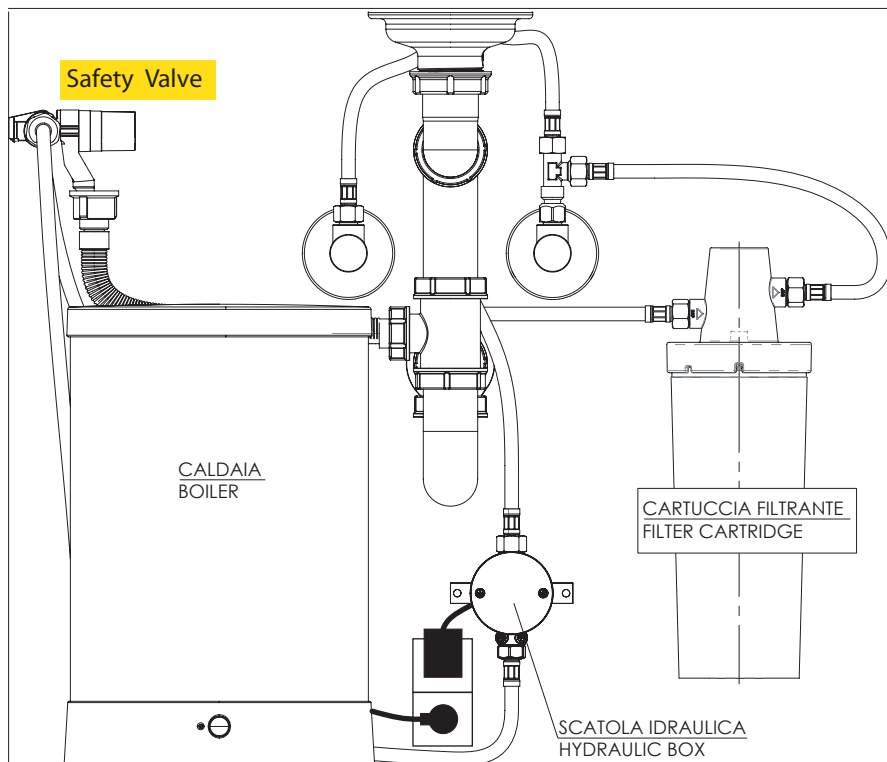

## FUNZIONAMENTO CALDAIA PRIMA ACCENSIONE BOILER OPERATION - SWITCHING ON FOR THE FIRST TIME

1

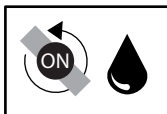

2

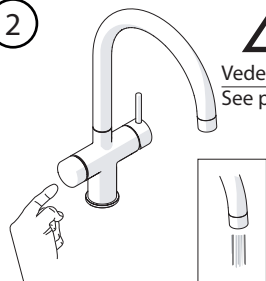

Vedere pag. 30-31  
See page.

Aziona la manopola di ebollizione del rubinetto.  
La caldaia si riempirà d'acqua.

L'aria uscirà dal rubinetto.

Risciacquare correttamente l'impianto:  
quando dal rubinetto fuoriesce un flusso laminare uniforme,  
l'impianto è correttamente risciacquato.

Operate the boiling knob of the tap.

The boiler will fill with water.

Air will come out of the tap.

Flush the system properly:

when there is a smooth laminar flow out of the tap,  
the system is properly flushed.

3

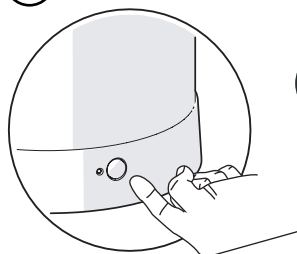

Accendere caldaia.  
Switch on the boiler.



LA CALDAIA SI ACCENDE **SEMPRE** SE E' **PIENA** D'ACQUA  
THE BOILER **ALWAYS** COMES ON IF IT IS **FULL** OF WATER



ROSSO  
RED

4



ROSSO  
RED

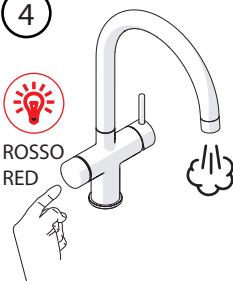

Riempimento acqua bollente  
Filling boiling water



Vedere pag. 30-31  
See page.

Ispezionare l'impianto per eventuali perdite dopo  
la messa in servizio.

Inspect the installation for leaks after  
commissioning.



5

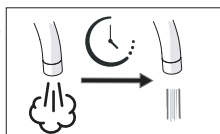

Per pulire il serbatoio aprire il rubinetto dell'acqua bollente  
fino a quando l'acqua diventa completamente fredda.

To clean the tank open the boiling water tap  
until the water gets completely cold.

**FUNZIONAMENTO MANIGLIA DI EBOLLIZIONE COLLEGATA ALLA CALDAIA**  
**OPERATION BOILING HANDLE CONNECTED TO THE BOILER**



ATTIVAZIONE  
ACTIVATION

2 POSSIBILITA'  
2 POSSIBILITIES

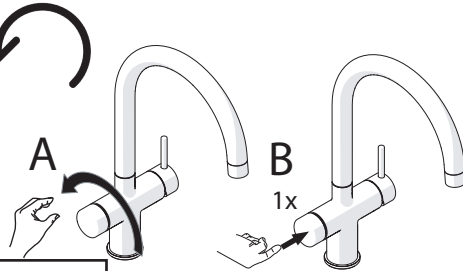
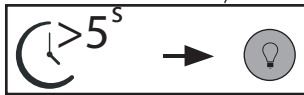

BIANCO  
WHITE

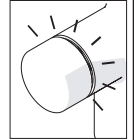

LUCE FISSA  
STEADY LIGHT



BOLLENTE  
BOILING

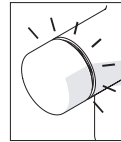

ROSSO  
RED



LUCE FISSA  
STEADY LIGHT

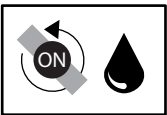

ATTIVAZIONE  
ACTIVATION

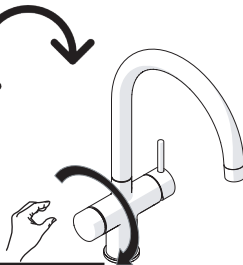
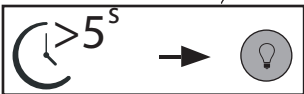

BIANCO  
WHITE

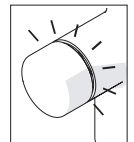

LUCE FISSA  
STEADY LIGHT



BOLLENTE  
BOILING

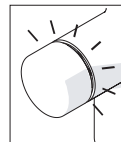
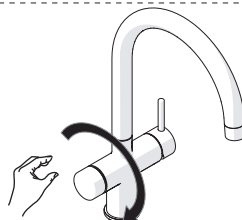







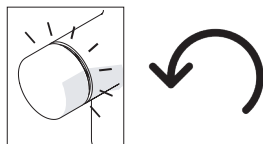







ROSSO  
RED

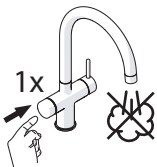
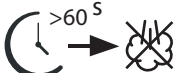

LUCE FISSA  
STEADY LIGHT



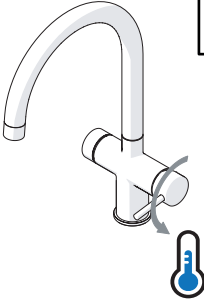



COLORE COLOR	CONDIZIONI CONDITION	GESTO GESTURE	RISULTATO LUMINOSO LIGHT OUTCOME
<b>ROSSO</b> <b>RED</b>	<p>Selezionare maniglia di ebollizione Select boiling handle tap</p> 	<p>Ruotare all'indietro Turn backwards</p>	 <b>LUCE FISSA</b> <b>STEADY LIGHT</b>
<b>ROSSO</b> <b>RED</b>	<p>Riempimento acqua bollente Filling boiling water</p>   <p>Disattivare: rilasciare la manopola Deactivate: Release the knob</p>	<p>Tenere premuto Keep pressed</p> 	   <p><b>ROSSO</b> <b>ROSSO</b> <b>RED</b> <b>RED</b></p> <p><u>lampeggiante</u> flashing</p>
	<p>Riempimento acqua bollente - 2° modalità Filling boiling water - 2° mode</p>   <p>Disattivare Deactivate</p> 	<p>Premere brevemente 2x Press briefly 2x</p> <p>Premere brevemente 1x Press briefly 1x</p>	   <p><b>ROSSO</b> <b>ROSSO</b> <b>RED</b> <b>RED</b></p> <p><u>Pulsante</u> Pulsating <u>meno luminoso</u> flashing less bright</p>



Dispositivo limitatore "dinamico" della portata d'acqua "50%"  
"Dynamic" flow rate restrictor "50%"





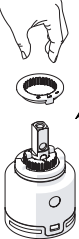

Per limitare la temperatura estrarre il limitatore e riposizionarlo nella posizione che si desidera  
Extract the limiter and put it in correct position to limit temperature

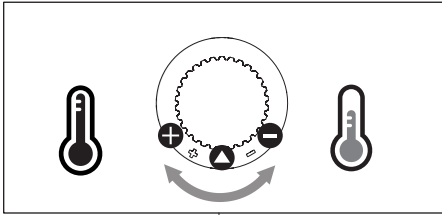

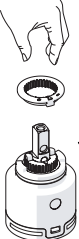



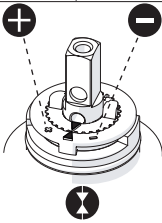
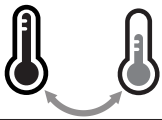

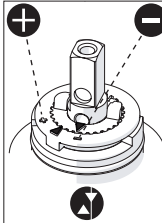
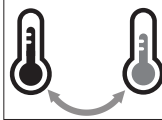

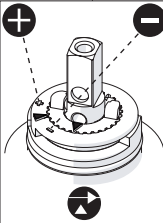



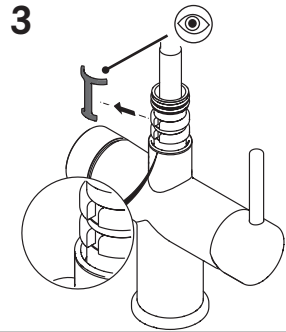
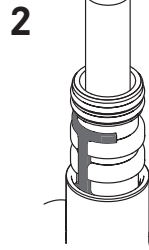
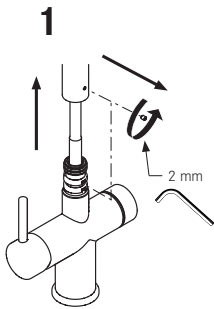
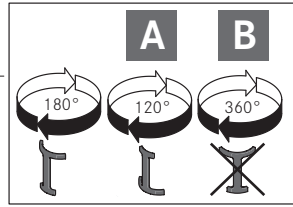
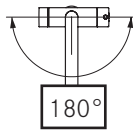
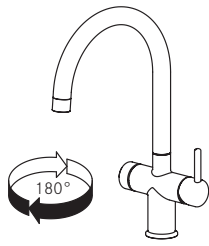

**A**

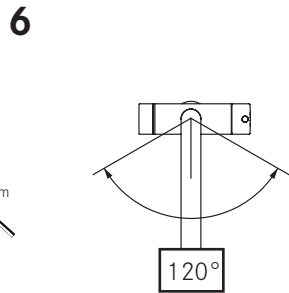
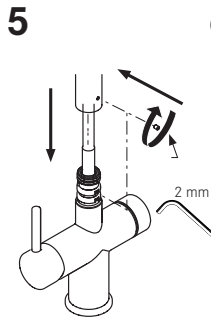
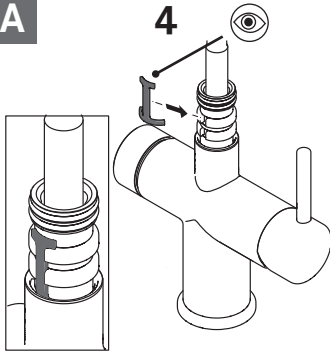

**B**

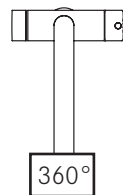
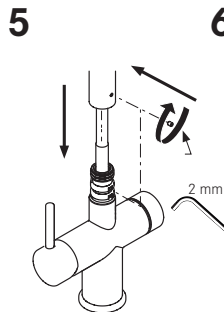
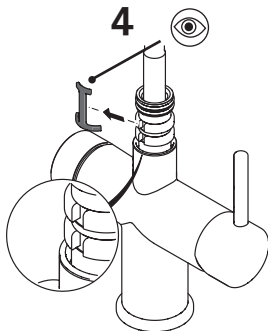

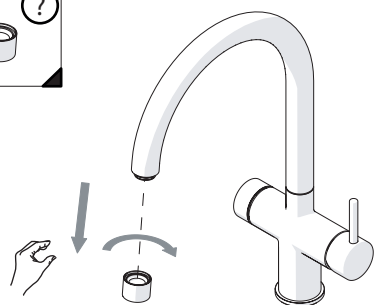
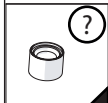
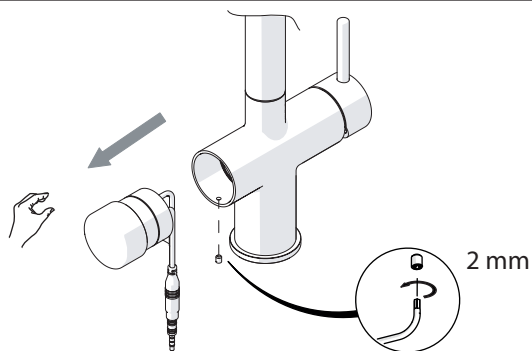
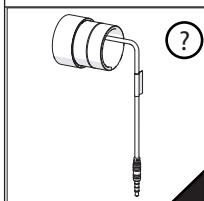
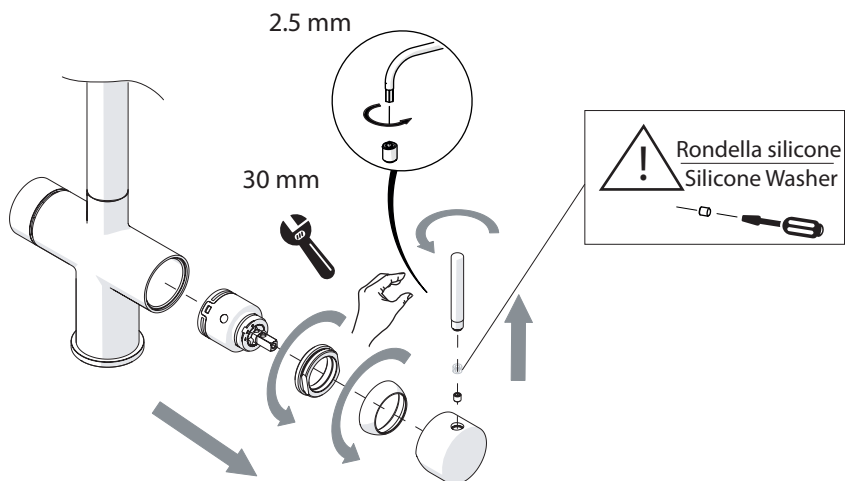
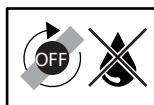

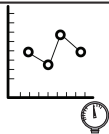

1

## PROVA USCITA AERATORE / TEST AERATOR

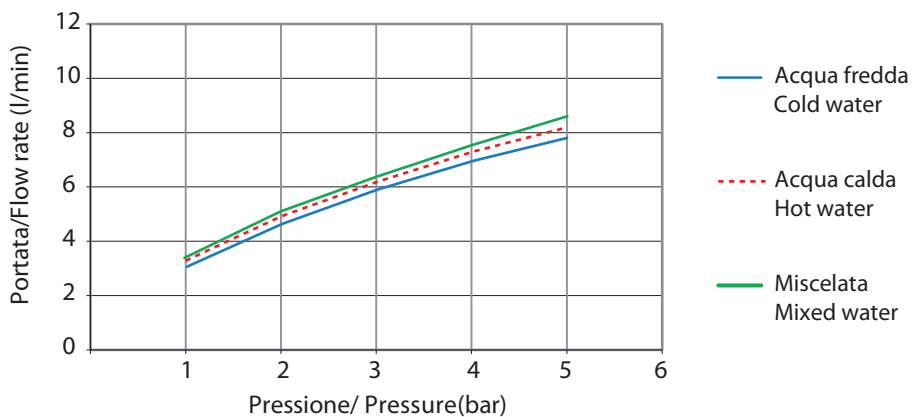

2

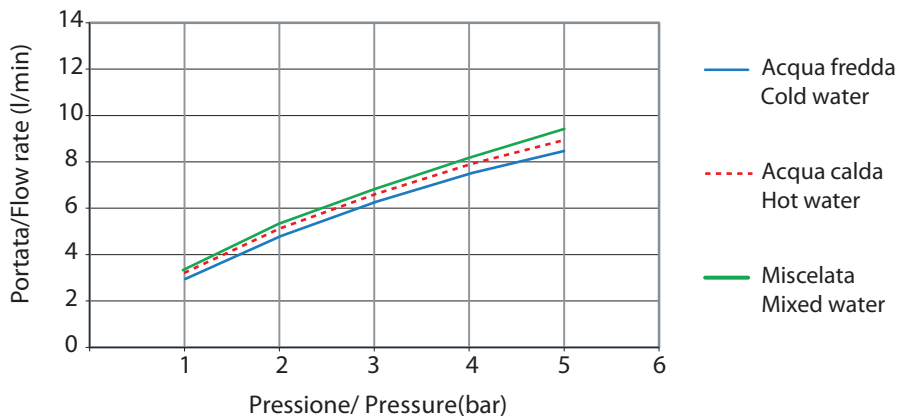

## PROVA USCITA AERATORE / TEST AERATOR



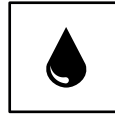

Portata acqua bollente mantenuto per 30 secondi a pressione di 3 bar = 4 l/min  
Boiling water flow rate held for 30 seconds at a pressure of 3 bar = 4 l/min

## PERDITE D'ACQUA DELL'IMPIANTO



Perdite nel collegamento	Ispezionare il/i giunto/i e serrare nuovamente, se necessario.
Tubo(i) che perde(i)	Ispezionare il/i flessibile/i e raddrizzare il/i flessibile/i attorcigliato/i.
Caldaia che perde	Staccare la spina della caldaia dalla presa di corrente. Chiudi l'approvvigionamento idrico.  
Rubinetto che perde	Chiudere l'alimentazione idrica. 

## SYSTEM WATER LEAKS

Connection leaking	Inspect the coupling(s) and re tighten, if necessary.
Hose(s) leaking	Inspect the hose(s) and replace the leaking hose(s).
Boiler leaking	Remove the plug of the boiler from the wall plug socket. Shut off the water supply.  
Tap leaking	Shut off the water supply. 

## AVVERTENZE USO DELLA CALDAIA

Non sollevare o trasportare mai la caldaia con i tubi flessibili o il cavo di alimentazione.

Quando la caldaia è spenta per almeno una settimana, si consiglia quanto segue:

- Accendere la caldaia. Attendere fino a quando l'acqua della caldaia è a temperatura.
- Aprire il rubinetto dell'acqua bollente e far fluire acqua bollente finché non fuoriesce acqua fredda del rubinetto.
- Riscaldare nuovamente l'acqua della caldaia.

### Mettere fuori servizio la caldaia

Qualora non avessi bisogno di acqua bollente per un periodo prolungato, come durante le vacanze, è possibile spegnere la caldaia (temporaneamente):

Utilizzare la modalità STANDBY della caldaia, oppure rimuovere la spina dalla presa a muro per evitare riscaldamento della caldaia.

### Caldaia fuori servizio

1. Staccare la spina della caldaia dalla parete presa elettrica.
2. Aprire il rubinetto dell'acqua bollente.
3. Attendere che l'acqua fredda finisca.
4. Chiudere il rubinetto dell'acqua bollente.
5. Chiudere la valvola di arresto.
6. Aprire il rubinetto dell'acqua bollente.
7. Attendere che l'acqua non finisca più.
8. Chiudere il rubinetto dell'acqua bollente.
9. Scollegare i tubi dalla caldaia.
10. Rimuovere la caldaia.
11. Far uscire l'acqua dai tubi e dalla caldaia per drenare nel lavandino.

## WARNINGS FOR USE OF THE BOILER

Never pick up or carry the boiler with the hoses or the mains lead.

When the boiler has been switched off for a week, we recommend that the following procedure is observed before use:

- Switch on boiler. Wait until the boiler water is up to temperature.
- Open the boiling water tap and flush the boiling water line until cold water comes out of the tap.
- Reheat the boiler water.

### Taking boiler out of service

If you do not expect to need any boiling water for a prolonged period, such as during holidays, you can switch off the boiler (temporarily):

Use the boiler STANDBY mode, or remove the plug from the wall plug socket to prevent heating of the boiler.







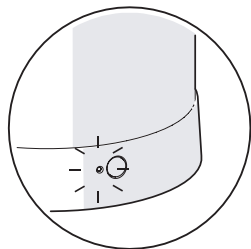

### Decommissioning boiler

1. Remove the plug of the boiler from the wall plug socket.
2. Turn on the boiling water tap.
3. Wait until cold water runs out.
4. Turn off the boiling water tap.
5. Close the stop valve.
6. Turn on the boiling water tap.
7. Wait until water no longer runs out.
8. Turn off the boiling water tap.
9. Disconnect the hoses from the boiler.
10. Remove the boiler.
11. Allow the water from the hoses and the boiler to drain into the sink.

## RIPARAZIONE GUASTI CALDAIA

### Indicazioni LED









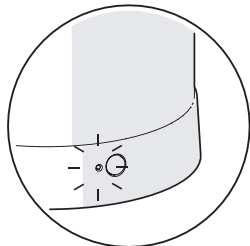

Colore	Messaggio	
Blu lampeggiante   	Mancanza di acqua nel boiler	Riempire acqua il boiler
Arancione lampeggiante   	Guasto nel sistema	Controllare il sistema completo, se l'allarme rimane, richiedere 

## TROUBLESHOOTING BOILER SYSTEM

### LED Indications



Color	Message	
Blue flashing   	No water in the boiler	Fill water in the boiler
Orange flashing   	System failure	Check the complete system, if the alarm remains, request 

## L'ACQUA DEL RUBINETTO NON BOLLE

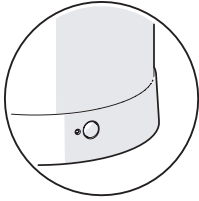

La spina della caldaia non è stata inserita in una presa di corrente a muro.	Inserire la spina in una presa a muro con messa a terra.
La presa a muro non ha alimentazione.	Controllare l'alimentazione elettrica. Il circuito elettrico è guasto a causa di un carico eccessivo. La caldaia non può essere collegata allo stesso circuito elettrico della lavastoviglie.
La caldaia è in OFF.	Accendere la caldaia (ON).
La caldaia non si è riscaldata completamente.	Attendere che la caldaia si sia riscaldata.
La caldaia è difettosa.	Richiedere 

## THE WATER FROM THE TAPS NOT BOILING



The plug of the boiler has not been inserted into a wall plug socket.	Insert the plug into an earthed wall plug socket.
The wall plug socket has no power supply.	Check the electricity supply. The electricity circuit has failed due to an excessive load. The boiler cannot be connected to the same electricity circuit as a dishwasher.
The boiler is OFF.	Switch the boiler ON.
The boiler has not heated up completely.	Wait until the boiler has heated up.
The boiler is defective.	Request 

## LA CALDAIA PROVOCA UN CORTOCIRCUITO

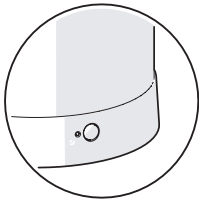

C'è un cortocircuito nel cablaggio elettrico o il riscaldatore elemento della caldaia.	Staccare la spina della caldaia dalla presa di corrente. Richiedere ☎️
Manca acqua in caldaia.	Riempire la caldaia con acqua.

## THE BOILER CAUSES A SHORT-CIRCUIT



There is a short-circuit in the electric wiring or the heater element of the boiler.	Remove the plug of the boiler from the wall plug socket. Request ☎️
No water in the boiler.	Fill the boiler with water.



## LA MANOPOLA ELETTRONICA NON RISPONDE



Problema software	Scollegare l'alimentazione per almeno 10 secondi.
Il connettore del cavo del rubinetto è non correttamente collegato.	Inserire saldamente il connettore del cavo.
La presa a muro non è alimentata	Controllare l'alimentazione elettrica. Il gruppo elettrico è guasto per un carico eccessivo. La caldaia non può essere collegata allo stesso gruppo elettrico di una lavastoviglie.
Il cavo o il connettore del rubinetto è danneggiato o difettoso.	Richiedere 

## ELECTRONIC KNOB DOES NOT RESPONDE



Software problem	Disconnect the power supply for at least 10 seconds.
The cable connector of the tap is not correctly connected.	Plug the cable connector securely.
The wall plug socket has no power supply.	Check the electricity supply. The electricity group has failed due to an excessive load. The boiler cannot be connected to the same electricity group as a dishwasher.
The cable or connector of the tap is damaged or defective	Request 

## RIPARAZIONE GUASTI SISTEMA FILTRO



L'apparecchio non eroga acqua filtrata	Alimentazione idrica o altre valvole di intercettazione chiuse	Controllare le valvole di intercettazione e, se necessario, aprirle
	Cartuccia filtrante non completamente avvitata nella testa di connessione	Ruotare la cartuccia filtrante di circa 1/2 giro e riposizionarla finché non si arresta
	Testa di connessione montata in modo errato	Direzione del flusso: controllare la freccia della direzione sulla testa di connessione e, se necessario, invertire la direzione del flusso
Bassa permeabilità all'acqua	La pressione del sistema è troppo bassa	Controllare la pressione del sistema
Perdita dalla connessione a vite	Guarnizione difettosa	Controllare la tenuta, se necessario sostituirla con una nuova

## TROUBLESHOOTING FILTER SYSTEM



Dispensing of filtered water is not possible	Water supply or other shut-off valves closed	Check shut-off valves and open if necessary
	Filter cartridge not completely screwed into the filter head	Unscrew the filter cartridge by half a turn, and then re-screw it into place to the proper stop.
	Filter head incorrectly mounted	Direction of flow – Check the direction arrow on filter head and reverse it if necessary
Low water throughput (permeability)	System pressure is too low	Check system pressure
Screw connection leaking	Gasket defective	Check the sealing gasket, and replace it with a new one if necessary

## AVVERTENZE USO DEL RUBINETTO ACQUA BOLLENTE WARNINGS USING THE TAP HOT WATER

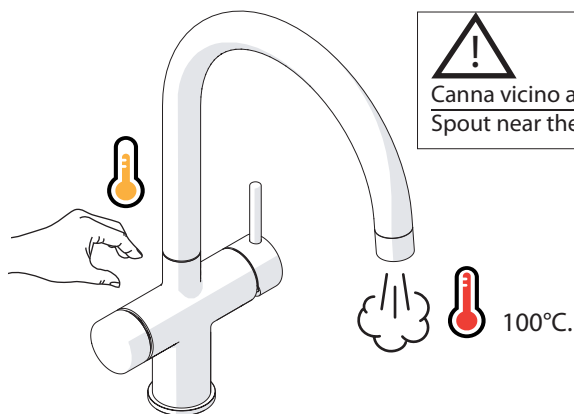
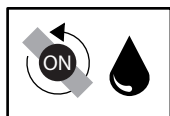

Per evitare ustioni e scottature prestare attenzione quando si utilizza acqua bollente. La temperatura dell'acqua può essere superiore a 100°C.

To avoid burns and scalding and pay attention when using boiling water. The temperature of the water may be higher than 100°C.

### TECNOLOGIA CORPO TIEPIDO WARM TECHNOLOGY



Durante l'erogazione dell'acqua bollente, se si tocca con mano il corpo, non c'è pericolo di ustioni, perchè il sistema rimane tiepido.

While dispensing boiling water, if you touch the body with your hand, there is no danger of burns, because the system remains warm.

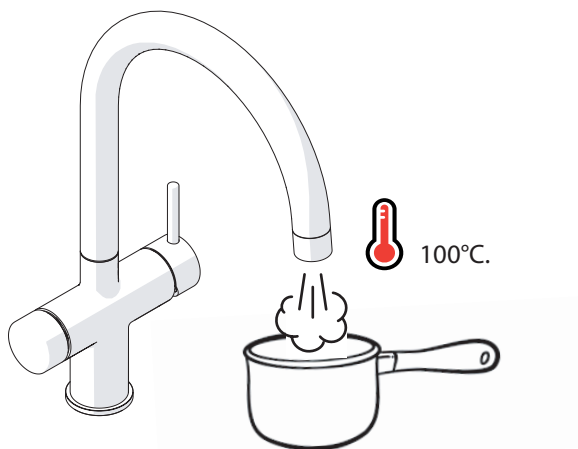
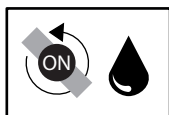

Tieni il pentolino da riempire vicino all'aeratore per impedire che l'acqua schizzi, evitando ustioni.

---

Keep the saucepan close to the aerator to prevent water from escaping splashes, avoiding burns.

Per un risultato ottimale durante la preparazione del caffè o tè, lasciare fuoriuscire circa 1 tazza d'acqua prima di riempire la pentola. In questo modo le bolle d'aria nell'acqua scompaiono e non ci sarà schiuma sulla superficie del caffè o tè.

---

For the optimum result when making coffee or tea, allow around 1 cup of water to run out before filling the pot. In this way the air bubbles in the water disappear so that no foam forms on the surface of the coffee or tea.





### SMALTIMENTO

Il simbolo sul prodotto o sulla confezione indica che il dispositivo non deve essere smaltito insieme ai rifiuti domestici. Smaltendo il dispositivo in modo corretto si contribuisce ad evitare conseguenze dannose per l'ambiente e la salute. Ulteriori informazioni sul riciclaggio del dispositivo sono disponibili presso l'autorità competente, il servizio locale di smaltimento dei rifiuti o il venditore del dispositivo. Smaltire il dispositivo, che deve essere smaltito, tramite un punto di raccolta rifiuti specializzato per dispositivi elettronici ed elettrici. Ai sensi dell'articolo del Decreto Legislativo n. 15 del 25 luglio, Attuazione della Direttiva 2002/96/CE relativa alla riduzione delle sostanze pericolose utilizzate nelle apparecchiature elettriche ed elettroniche e nello smaltimento dei rifiuti. Il simbolo della pattumiera barrata presente sull'apparecchio indica che al termine della sua vita utile il prodotto non deve essere smaltito insieme ai rifiuti domestici. Di conseguenza, quando l'apparecchio ha raggiunto la fine della sua vita utile, l'utente deve portarlo presso un idoneo centro di riciclaggio per rifiuti elettronici ed elettrotecnici, oppure restituirlo al rivenditore al momento dell'acquisto di un nuovo apparecchio di tipo equivalente. Una corretta raccolta differenziata dell'apparecchio rottamato per il successivo riciclaggio, trattamento e smaltimento ecocompatibile aiuta a prevenire potenziali impatti negativi sull'ambiente e sulla salute e facilita il riciclaggio dei materiali utilizzati nella costruzione dell'apparecchio.



### DISPOSAL

The symbol on the product or on the packaging indicates that the device must not be disposed of in the domestic waste. By disposing of the device in a proper way you help to avoid harmful consequences to environment and health. Further information about recycling the device is available from the competent authority, the local refuse disposal service or the vendor of the device. Dispose of the device, which is to be discarded, via a specialised waste collection point for electronic and electrical devices. In accordance with the article of Legislative Decree no. 15 dated 25 July, Implementation of Directive 2002/96/EC regarding the reduction of the hazardous substances used in electrical and electronic appliances and in waste disposal. The barred dustbin symbol on the appliance indicates that at the end of its working life the product must not be disposed of as household waste. Consequently, when the appliance has reached the end of its working life the user must take it to a suitable recycling centre for electronic and electrotechnical waste, or return it to the dealer when purchasing a new appliance of equivalent type. Proper separate waste collection of the scrapped appliance for subsequent recycling, treatment and environmentally-friendly disposal helps prevent a potentially negative impact on the environment and health and facilitates recycling of the materials used in appliance construction.

**OPTIONAL:  
CONTALITRI ELETTRONICO/ELECTRONIC LITER COUNTER**

**KVR93096/CLA**

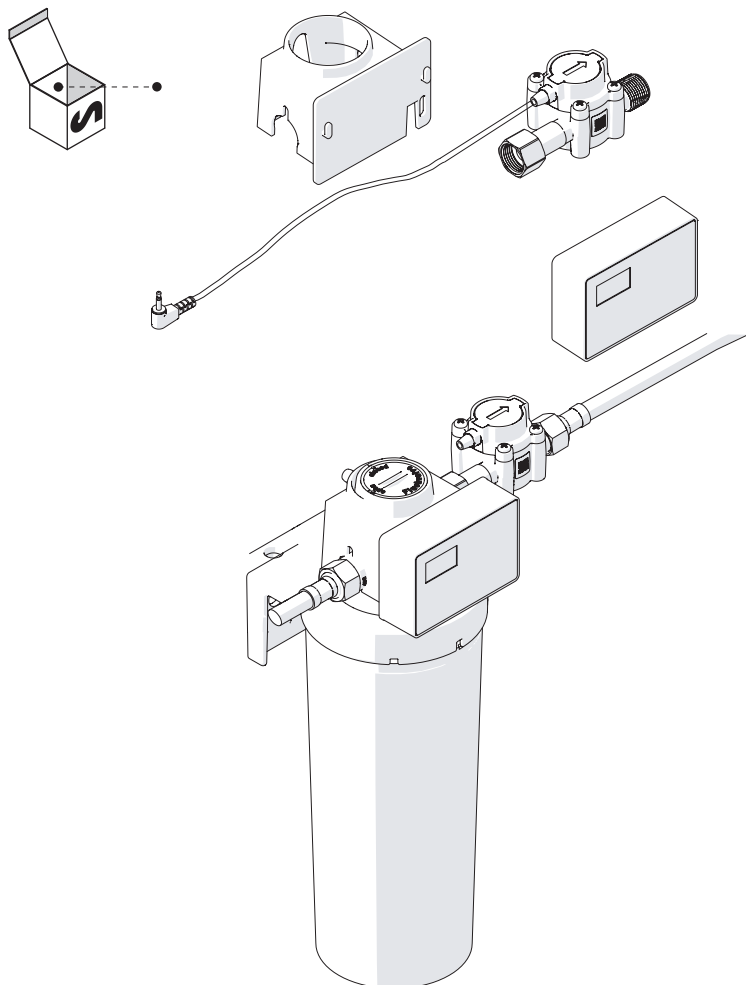

Ordinare filtro  
Order filter



# NOTE

Per TUTTE le indicazioni specifiche sulla cartuccia filtrante-Boiler fare riferimento alle istruzioni all'interno delle scatole.

For ALL specific indications on the filter cartridge-Boiler refer to the instructions inside the boxes.

PARTI DI RICAMBIO RUBINETTO CONSULTARE IL SITO [www.nobili.it](http://www.nobili.it)  
 SPARE PARTS TAP CONSULT THE SITE

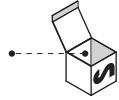

## PULIZIA CLEANING

### PULIZIA AERATORE CLEANING THE AERATOR

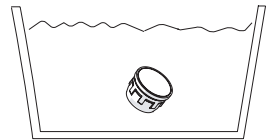
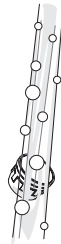

50% ACETO BIANCO+50% ACQUA  
 WHITE VINEGAR+50% WATER

 ACQUA WATER ✓	 SI CROMO YES CHROME NO PVD ALCOOL ALCOHOL ✓	 100% COTONE COTTON ✓	 SPUGNA SPONGE ✗	 DETERGENTI DETERGENT ✗
 TUTTE LE FINITURE ALL FINISHES ACQUA E SAPONE WATER AND SOAP ✓		 ASCIUGARE BENE SEMPRE ALWAYS DRY WELL ⚠		

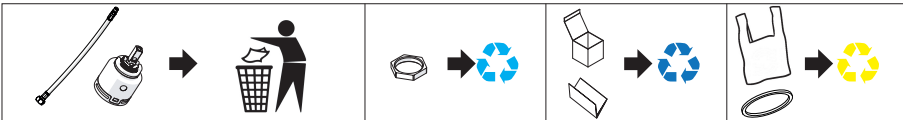

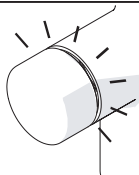

## SCHEMA LED MANIGLIA DI EBOLLIZIONE LED BOILING HANDLE SCHEME

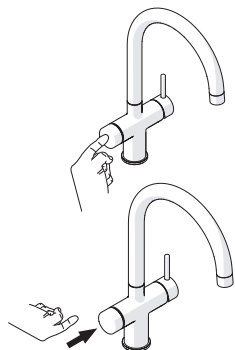

ROSSO  
RED



100°C



X 2



100°C

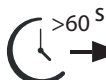

### VERIFICARE I REQUISITI MINIMI DI INSTALLAZIONE

- SCARICARE MANUALI E DOCUMENTAZIONE TECNICA
- CONSULTARE TUTORIAL DI INSTALLAZIONE
- TROVARE ASSISTENZA TECNICA SUL TERRITORIO
- COLLEGARSI CON SERVIZIO POST VENDITA NOBILI
- ORDINARE FILTRI
- CONSULTAZIONE GARANZIA

### CHECK THE MINIMUM INSTALLATION REQUIREMENTS

- DOWNLOAD MANUALS AND TECHNICAL DOCUMENTATION
- CONSULT INSTALLATION TUTORIAL
- FIND TECHNICAL ASSISTANCE IN THE TERRITORY
- CONNECT WITH NOBILI AFTER-SALES SERVICE
- ORDER FILTERS
- WARRANTY CONSULTATION



LE ISTRUZIONI DEVONO ESSERE CONSERVATE NELLE IMMEDIATE VICINANZE DEL PRODOTTO

THE INSTRUCTIONS MUST BE KEPT IN THE IMMEDIATE VICINITY OF THE PRODUCT

IISTRV0K133/EHT#---STD



REV0.01/2024