

Not included / Non incluso / Non Inclus / Nie zawarty/ No incluido / Nao incluido

1

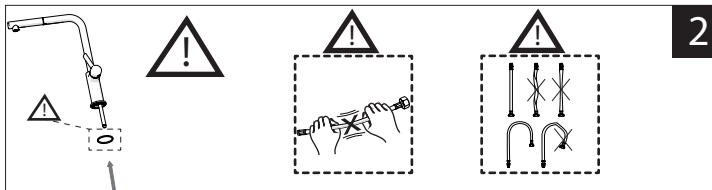

2

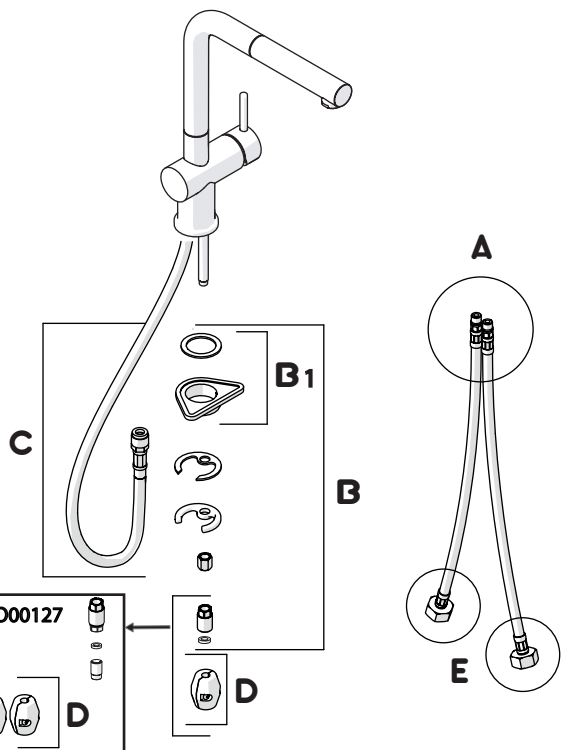
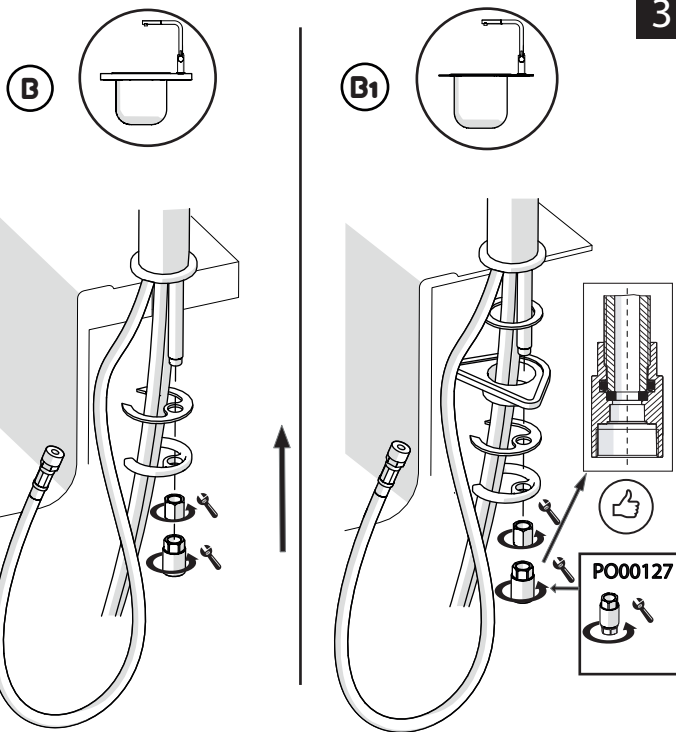
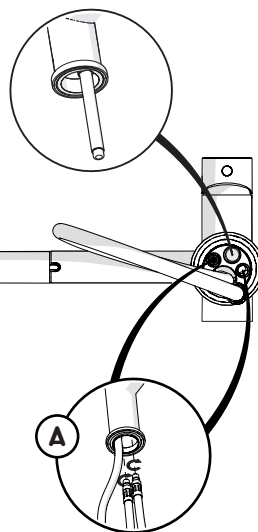

3

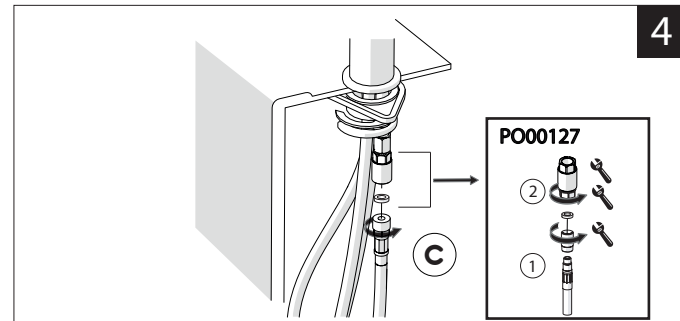

4

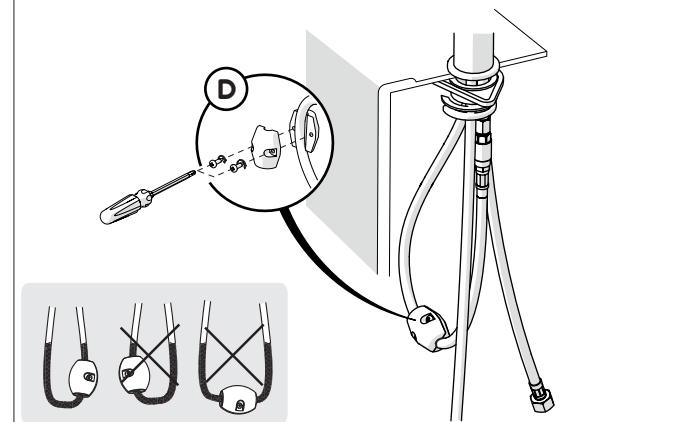

5

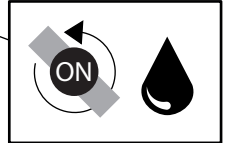
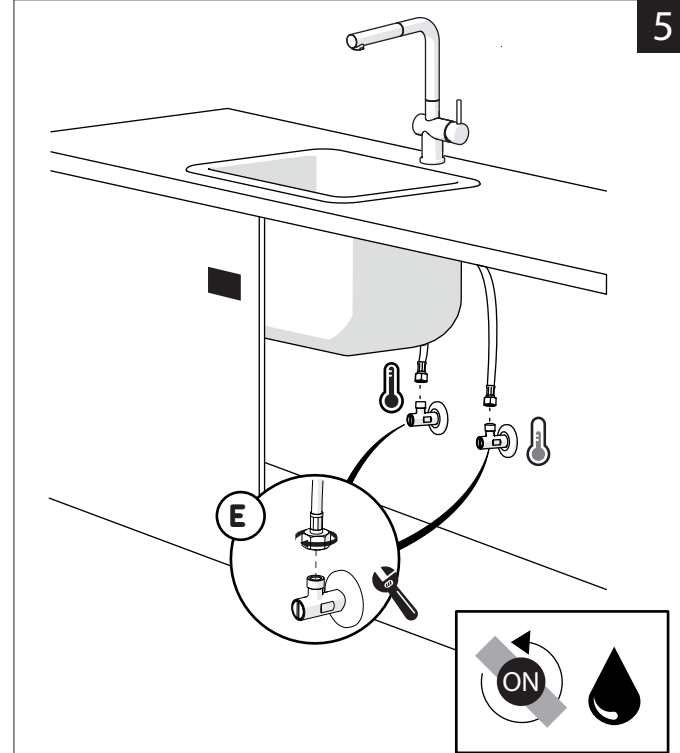

**-50%**

Dispositivo limitatore "dinamico" della portata d'acqua "50%"  
"Dinamic" flow rate restrictor "50%"

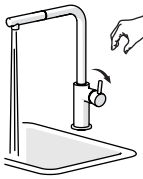
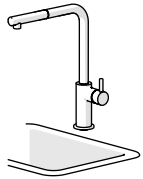

**ECO**



ON 50%

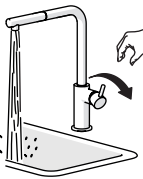

ON 100%



VALVOLA DI NON RITORNO ALL'INTERNO DOCCETTA  
NON-RETURN VALVE INSIDE HANDSHOWER

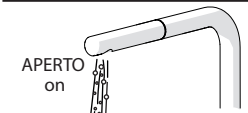
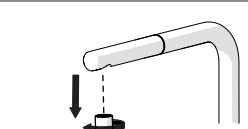

APERTO  
on

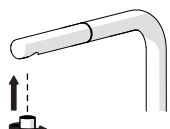

ESEMPI DISEGNO TECNICO  
EXAMPLES OF TECHNICAL DRAWING

**6**

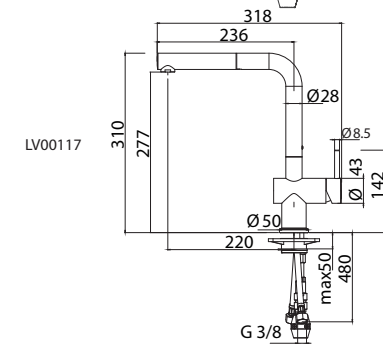
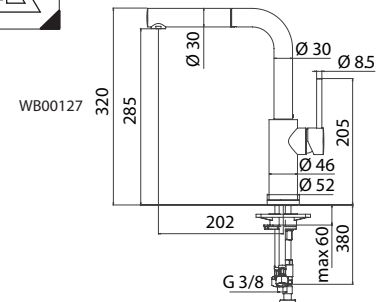

- OZ917/9T5
- LV00117
- WB00127
- PO00127

GENERICA/GENERIC



**7**

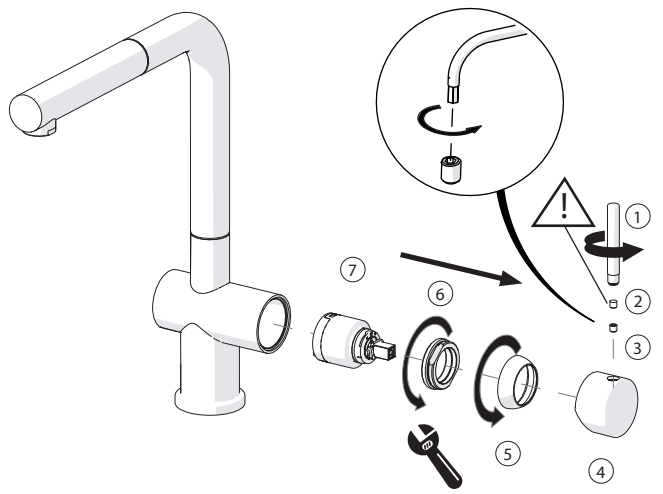
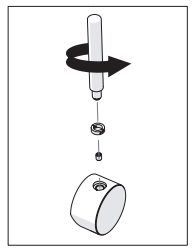
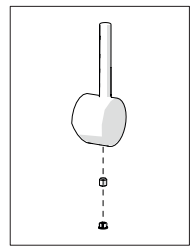

**8**

Per limitare la temperatura estrarre il limitatore e riposizionarlo nella posizione che si desidera

Extract the limiter and put it in correct position to limit temperature

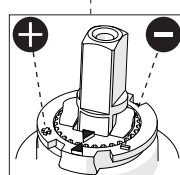
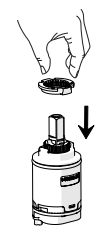
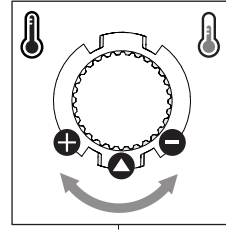
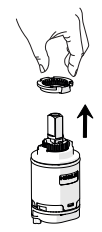

Nessuna limitazione di temperatura  
No limitation of temperature

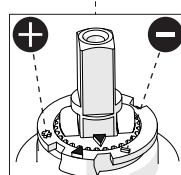

Limitazione parziale di temperatura  
Partial limitation of temperature

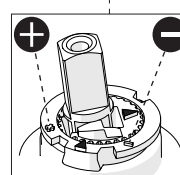

Massima limitazione Solo acqua fredda  
Maximum position Only cold water



www.grupponobili.it

PRIMA DI INIZIARE / BEFORE STARTING

	P bar		0.5 MIN		MAX 10		5		T ∞ °C		MAX 80		65 - 45
--	----------	--	------------	--	-----------	--	---	--	--------------	--	-----------	--	---------------

PULIZIA / CLEANING

	ACQUA WATER		ALCOOL		MICROFIBRA MICROFIBER		SPUGNA SPONGE		DETERGENTI DETERGENT
✓	✓	✓	✓	✓	✗	✗	✗		

IISTROZ917/9#---STD



REV3.03/2016