

Not included / Non incluso / Non Inclus / Nie zawarty/ No incluido / Nao incluido

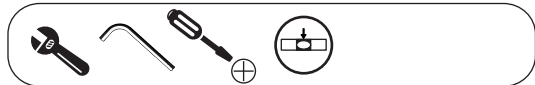

1

A

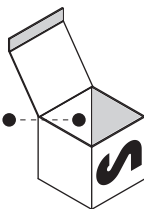

B

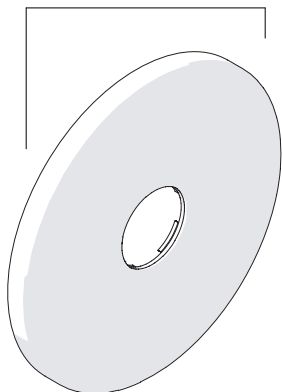

C

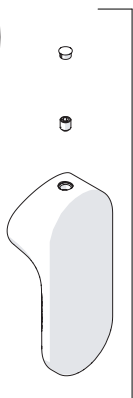

2



A

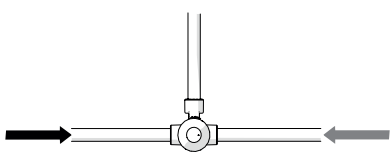
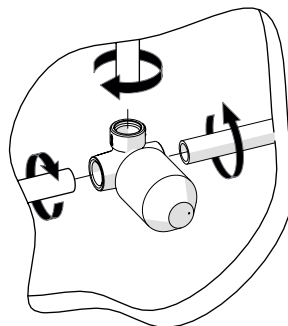

TEST PER I TUBI  
PRIMA DELLA CARTUCCIA (A)  
TEST FOR THE PIPES  
BEFORE CARTRIDGE (A)

ATTENZIONE!  
Durante il test la cartuccia deve essere  
in posizione "chiusa"!

ATTENTION!  
During test cartridge must be  
placed in "CLOSED POSITION"



TEST

TEST PER I TUBI  
DOPO LA CARTUCCIA (B)

TEST FOR THE PIPES  
AFTER CARTRIDGE (B)

ATTENZIONE!  
Secondo la norma europea EN817, in caso  
di test per i tubi dopo la cartuccia, la pressione  
deve essere a 4 bar per 1 minuto e la cartuccia  
in posizione "aperta"

ATTENTION!  
As per european rule EN817, in  
case of test for the pipes after  
cartridge, the pressure must be  
within 4 bar for 1 minute and the  
cartridge in "open position"

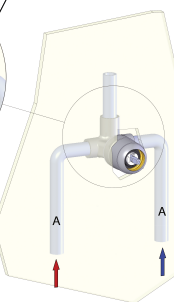
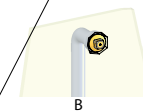
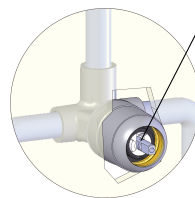

4

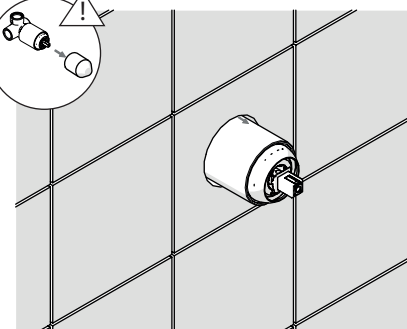
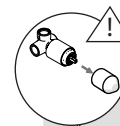
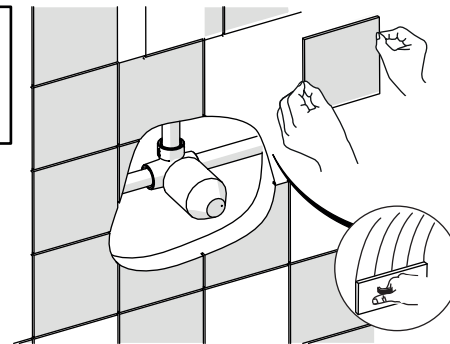

5

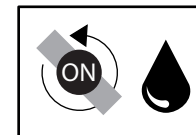
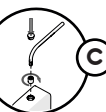
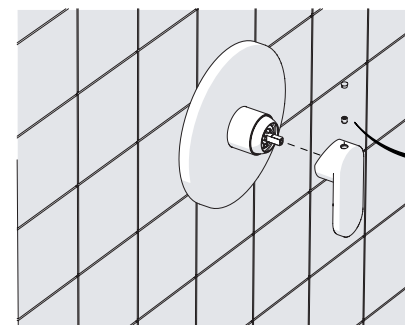
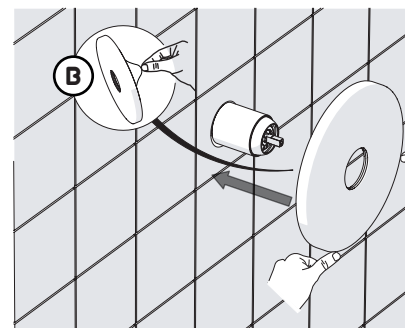



Dispositivo limitatore "dinamico" della portata d'acqua "50%"  
"Dynamic" flow rate restrictor "50%"

6

CLOSE ON 50% ON 100%

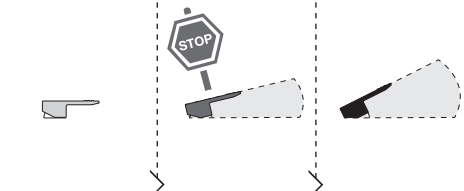

Posizione di chiusura  
Closed position

Posizione di risparmio acqua "50% portata"  
Position of water saving "50% capacity"

Posizione di apertura totale 100% portata  
100% Fully open flow

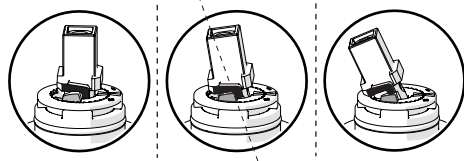

7

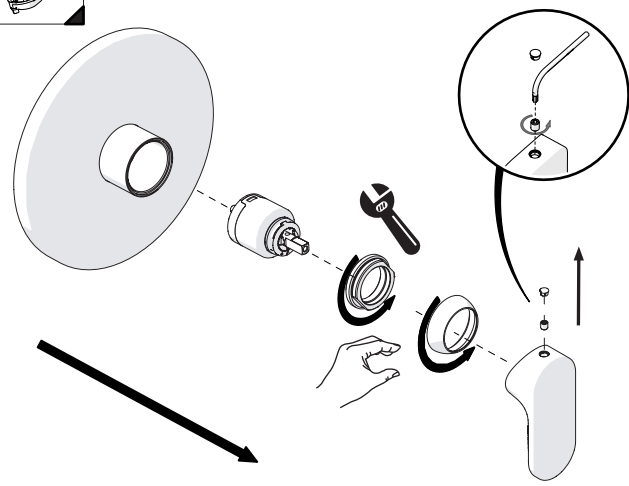

Per limitare la temperatura estrarre il limitatore e riposizionarlo nella posizione che si desidera  
Extract the limiter and put it in correct position to limit temperature

8

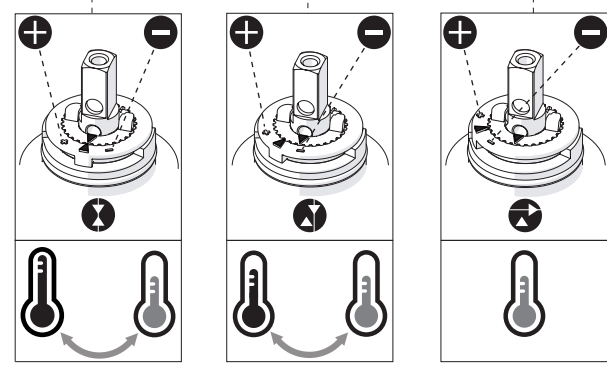
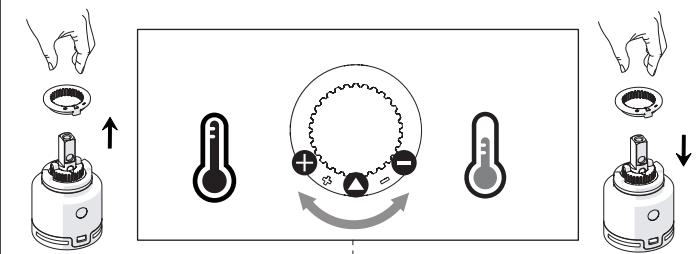

9

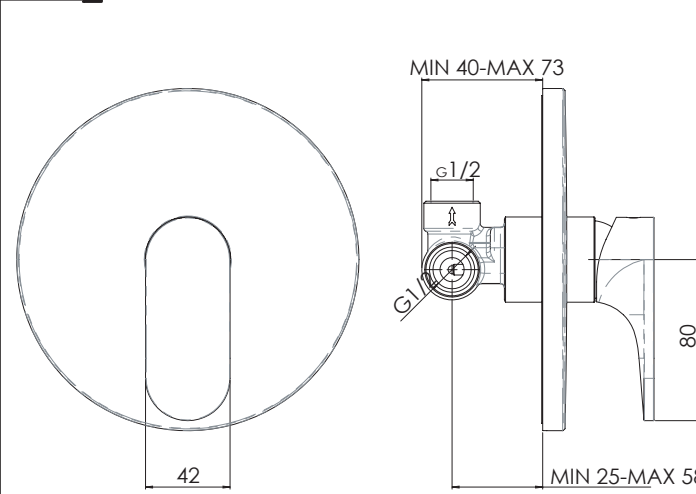

NOBILI S

YOYO

YO126108

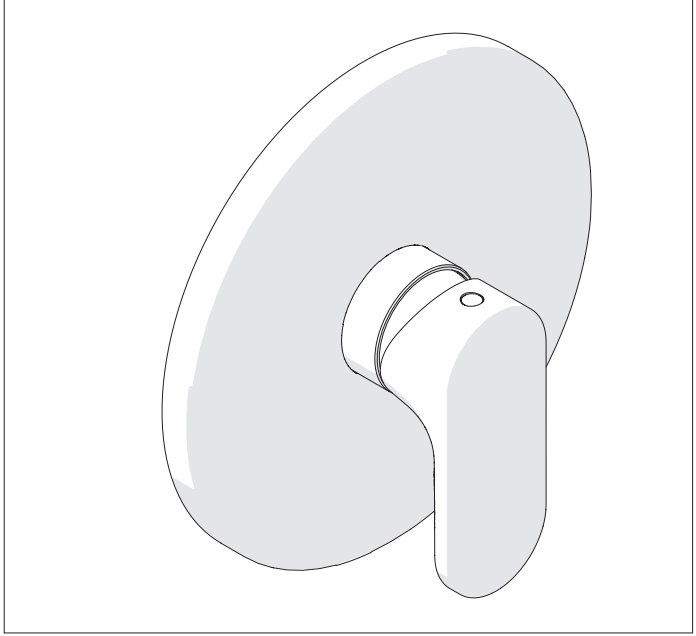

www.nobili.it

PRIMA DI INIZIARE / BEFORE STARTING



PULIZIA / CLEANING

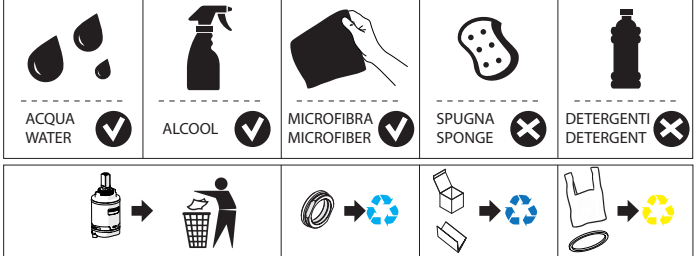

IISTRYO126108#---STD



REV0.10/2020