

INSTALLATION INSTRUCTION

Nova

Downlight

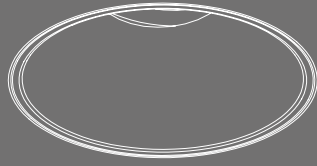

Dimensions

Nova Trimless

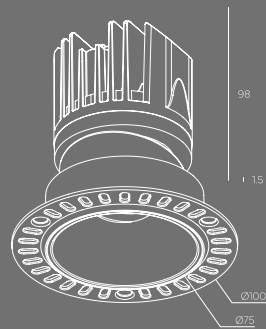

GENERAL WARNINGS

1. The safety of the appliance is only guaranteed if these instructions are fully observed both during installation and in normal use; they must therefore be retained.

2. The assembly, installation and commissioning of the appliance may only be carried out by trained personnel or authorised technicians, in compliance with these assembly instructions and all applicable standards and regulations for the respective field of application.

3. During the first installation and/or routine maintenance, check the electrical, mechanical, and thermal compatibility of the luminaire with its intended purpose, and after installation make sure it is securely fastened. Before any replacement of light sources, make sure that the electrical power is turned off and that the luminaire has had time to cool down.

4. To clean the device, use a soft cloth moistened by a common pH-neutral, alcohol-free, nonabrasive detergent.

5. The device is not suitable for outdoor installation.

6. The efficiency and longevity of the device are ensured by proper and periodic maintenance.

7. The luminaire may be used only when complete with all its components and intact in all its parts. Any modification work on the product, subsequent to its sale, may compromise electrical safety as well as invalidate the warranty.

8. The luminaire may be used only when complete with all its components and intact in all its parts. Any modification work on the product, subsequent to its sale, may compromise electrical safety as well as invalidate the warranty.

Sanaura

www.sanipexgroup.com

IP65

Total protection against any small objects and against powerful water jets



Electrical insulation class I

220/240 V
50/60 Hz

Mains voltage
at 220-240V / 50-60Hz

CC

Remoted CC driver

RG1

RG Value



Maximum allowable ambient temperature



Caution: danger of electric shock



The mains connection cable must always be routed out of the reach of children



Don't touch the LED source



Switch off mains voltage before luminaries installation

1 Product Wiring



CC (Constant Current) Driver - not dimmable				
Distance	5 m / 16 ft	10 m / 32 ft	20 m / 65 ft	50 m / 164 ft
Cable section	0,25 mm ² / AWG23	0,25 mm ² / AWG23	0,5 mm ² / AWG17	1 mm ² / AWG17
CC (Constant Current) Driver - dimmable				
Distance	5 m / 16 ft	10 m / 32 ft	15 m / 49 ft	-
Cable section	0,5 mm ² / AWG20	0,5 mm ² / AWG20	1 mm ² / AWG17	-

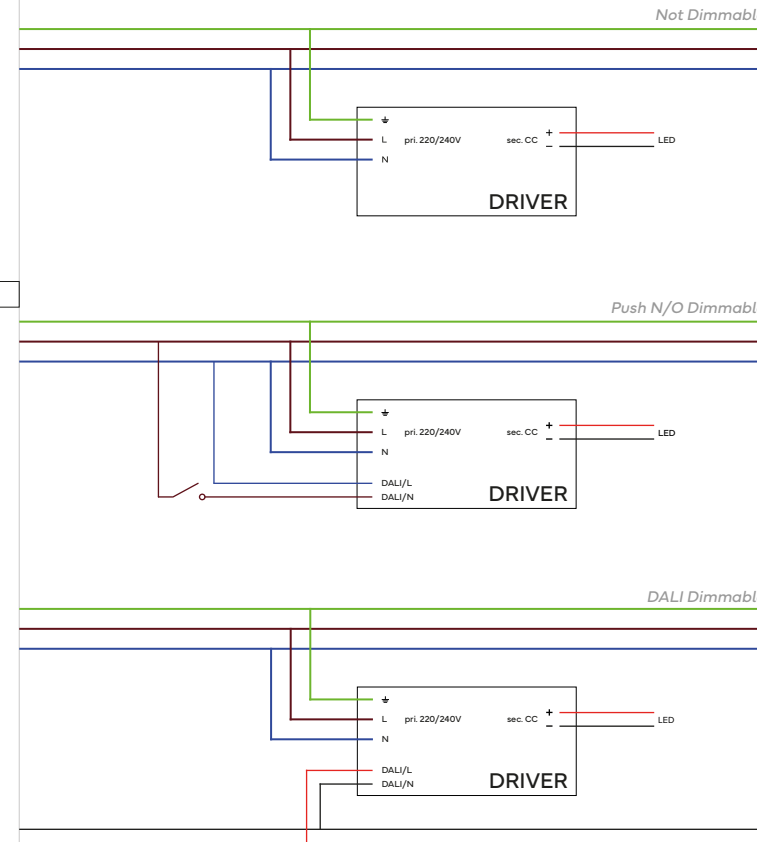

2 Hole drilling

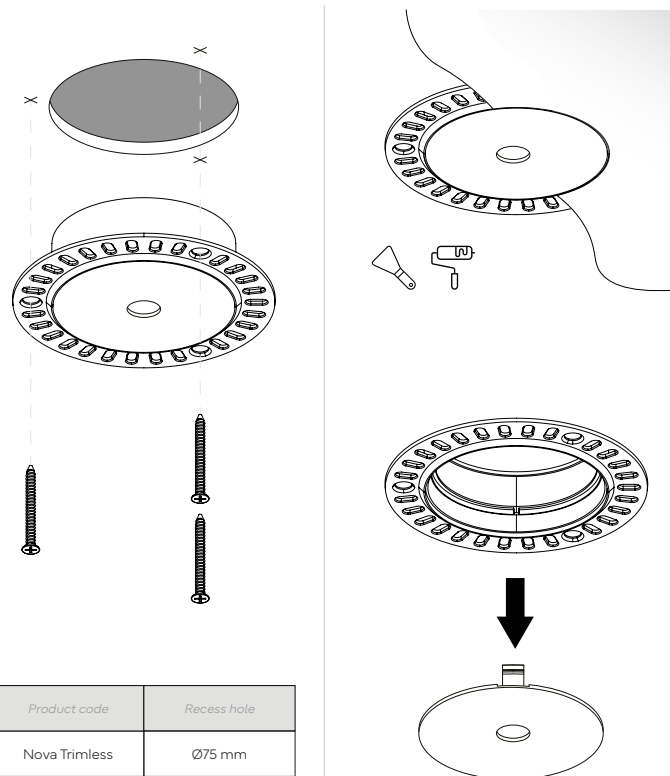

2 Source Adjustability

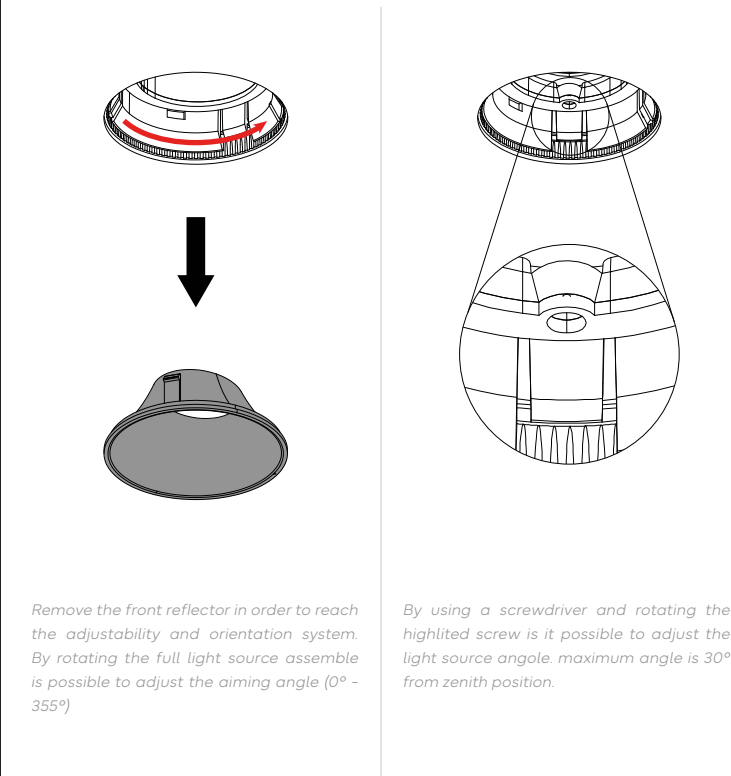

3 Reflector repositioning

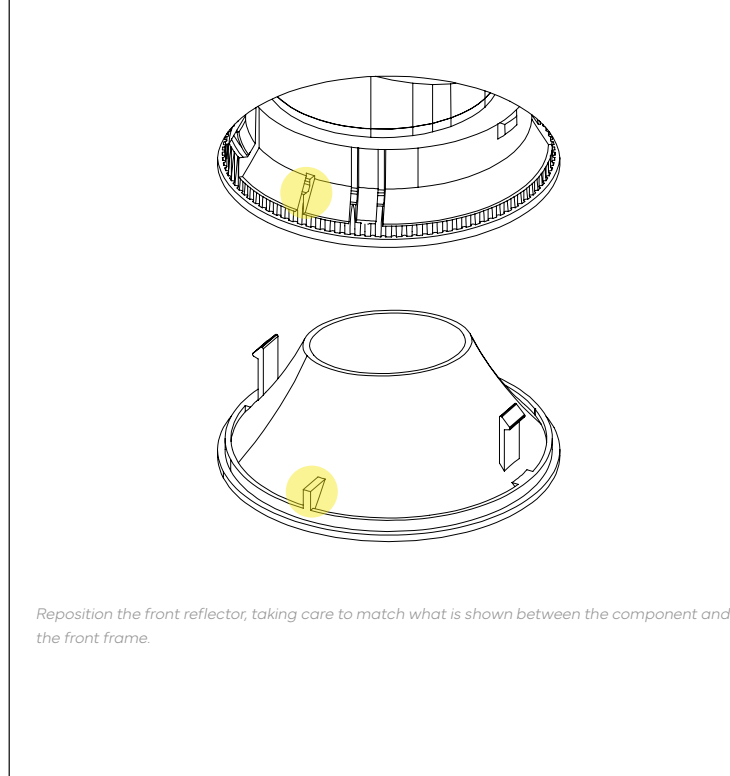

Energetic Class - Light Source

G 2700K / 3000K / 4000K

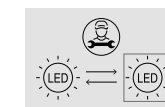
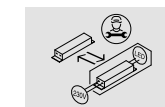

5 years Warranty up to

