

- FR** Mitigeur de lavabo mural à encastrer ( arrivées 1/2" et 1 sortie 1/2" ) avec bec.
- EN** Concealed wall-mounted basin mixer (1/2" inlet and 1 1/2" outlet) with spout.
- CN** 隱藏式壁掛面盆龍頭 ( 1/2 英寸入口和 1 1/2 英寸出口 ) , 帶出水嘴。
- DE** Wand-Waschtischmischer Unterputz ( 1/2" Zuläufe und 1 1/2" Ablauf) mit Auslauf.
- ES** Mezclador de lavabo empotrado en la pared (entrada de 1/2" y salida de 1 1/2") con caño.
- IT** Miscelatore da incasso per lavabo (ingresso da 1/2" e uscita da 1 1/2") con bocca di erogazione.
- NL** Inbouw wastafelmengkraan voor wandmontage (1/2" toevoer en 1 1/2" afvoer) met uitloop.
- RU** Настенный смеситель для раковины скрытого монтажа (вход 1/2" и выход 1 x 1/2") с изливом.

عم (صوب 1 1/2 جرحم و صوب 1/2 لخدم) طئاجلا ىل ع تبثم ي فخم ضوح طالخ  
ةوف: **AR**

**Outillage (Non-fourni)**  
Tools (Not provided)

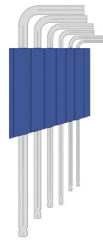

Compatible avec

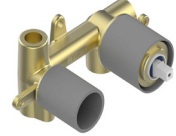

5840/MA  
5840/MA/W

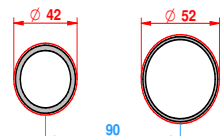

Ø de perçage conseillé  
recommended drilling o  
empfohlener abstand  
Ø de perforación aconsejado

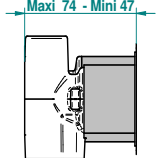

**Different type de queues / Different type of spout connection**

|  |   |   |                                |           |                          |  |
|--|---|---|--------------------------------|-----------|--------------------------|--|
|  |   |   |                                |           |                          |  |
| A2N - A2R - A2S - A2T<br>- A2U - A41 - A4J - A4K<br>- A4L - A7A - A7B - A7F<br>- A7G - A8M - A8N - A8P<br>- A8R - A8S - A9B - V1E<br>- E53 - G04 - G9A - G9B<br>- G9C - G9D - G9E - G9F<br>- G9G - G9H - G9J - G9K<br>- U1D - U4A - U4B - U4C<br>- U4F - U5A - U5D - U5G<br>- U5H - U5J - U5B - U5C<br>- U6M - U6N - U6P - U7A<br>- U7B - U7C - U7D - U7E<br>- U8A | A33 - A34 - A35 - A6A - A6B - A6G<br>- A6H - A6N - A6P - G1T - G1U<br>- G79 - G2J - G2K - G2T - G2U - G58<br>- G69 - G3P - G3Q - G3R - G3S<br>- G3T - G3U - G3V - G3W - G4R<br>- G4S - G6C - G6D - G6E - G6F<br>- G6G - G6H - G7R - G7E - G7F<br>- G7G - G7H - G7J - G7S - G7T - G7U<br>- G7V - G7W - G7X - G7Y - U2A -<br>U2B - U2L - U2M - U2N - U2P - U2R<br>- U3J - U3K - U3L - U4J - U4K -<br>U4L - U5K - U5L - U5N - U9A - U9B<br>- U9C - U9D - U9E - U9F - U9G -<br>U9H - U9I - U9J - U9K - U9L - U9M<br>- U9N - U9P - U9Q - U9R - U9S | D5A - G4P - G5A<br>- G5B - T5A - G5D<br>- G8A - G8B - U5P<br>- U6A - U6B - U6C -<br>U6D - U6E | G08 - G29 - G75 -<br>G3N - G47 | G7A - G7B | G7C - G7D - G7K<br>- G7L | U7G - U7H - U7J -<br>U7K - U7L - U7M<br>- U7N - U7P - U7S<br>- U7T |

Montage de mitigeur de lavabo mural  
Installation of wall-mounted washbasin mixer  
安装壁挂式洗脸盆龙头  
Montage von Wand-Waschtischmischer  
Instalación de mezclador mural para lavabo  
Installazione di un miscelatore per lavabo a parete  
Installatie van wandgemonteerde wastafelmengkraan  
Установка настенного смесителя для раковины  
طئاح ال ىل ع تثم ال لىسغ ال ضوح طالخ بيكرت

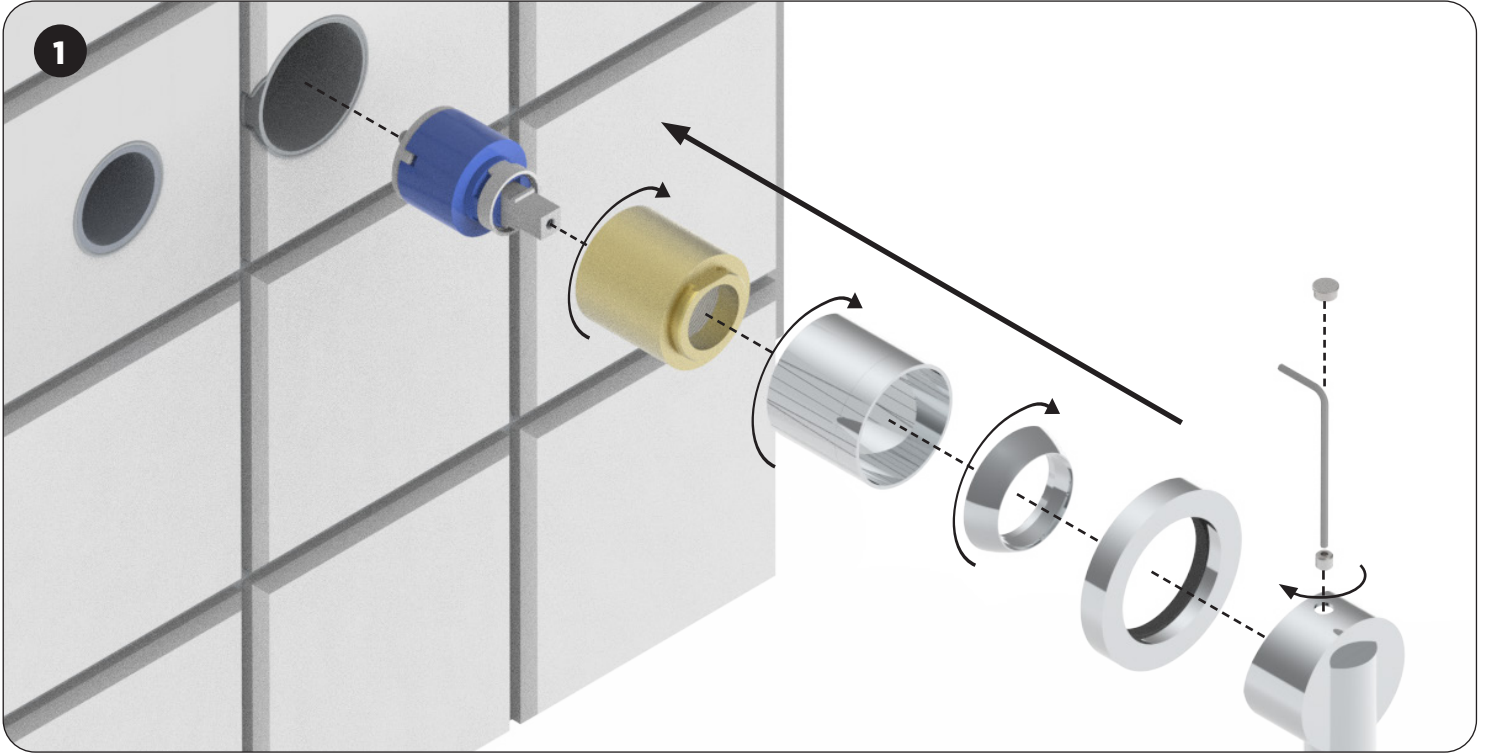

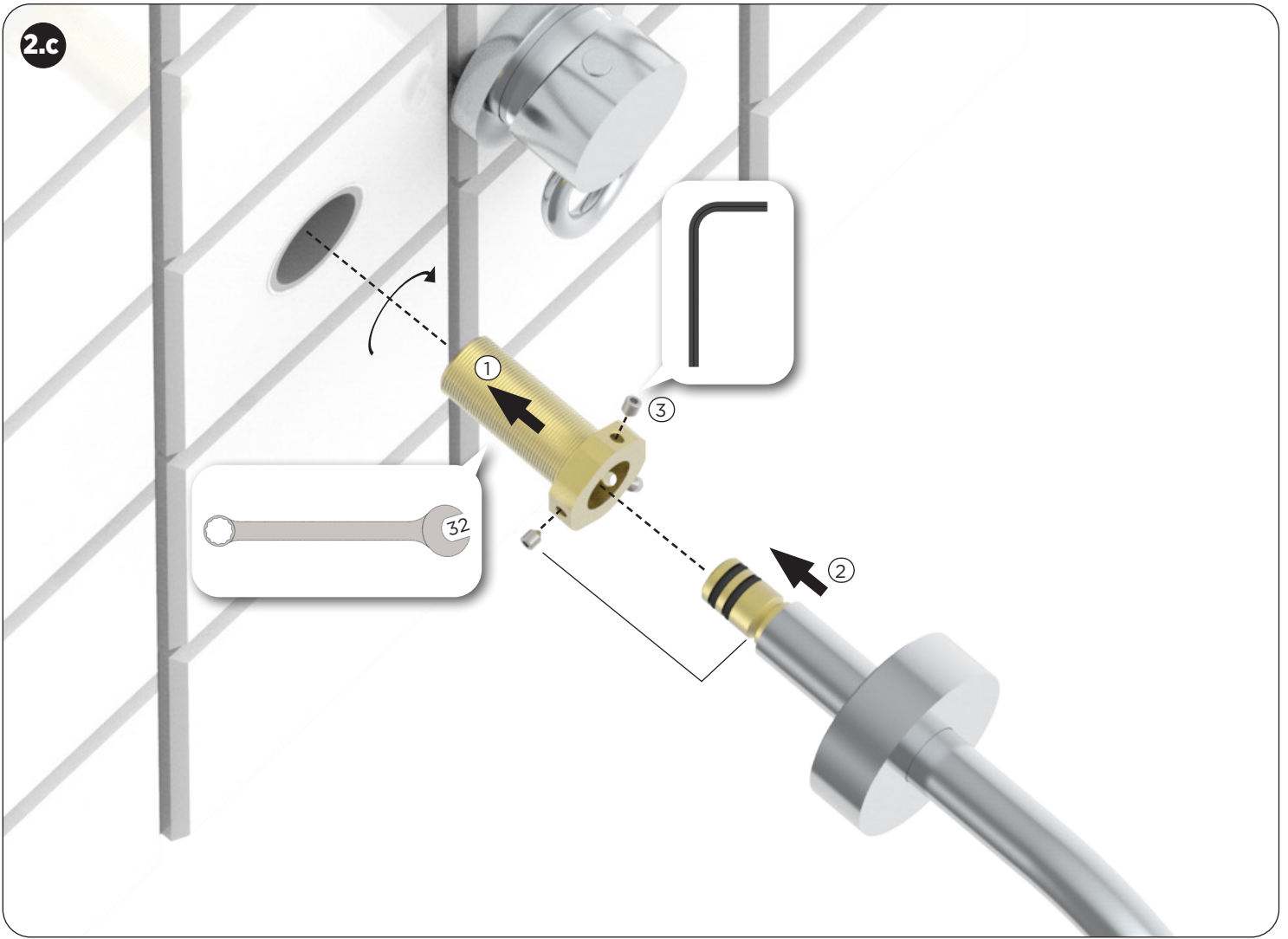

2.e



2.f



2.g

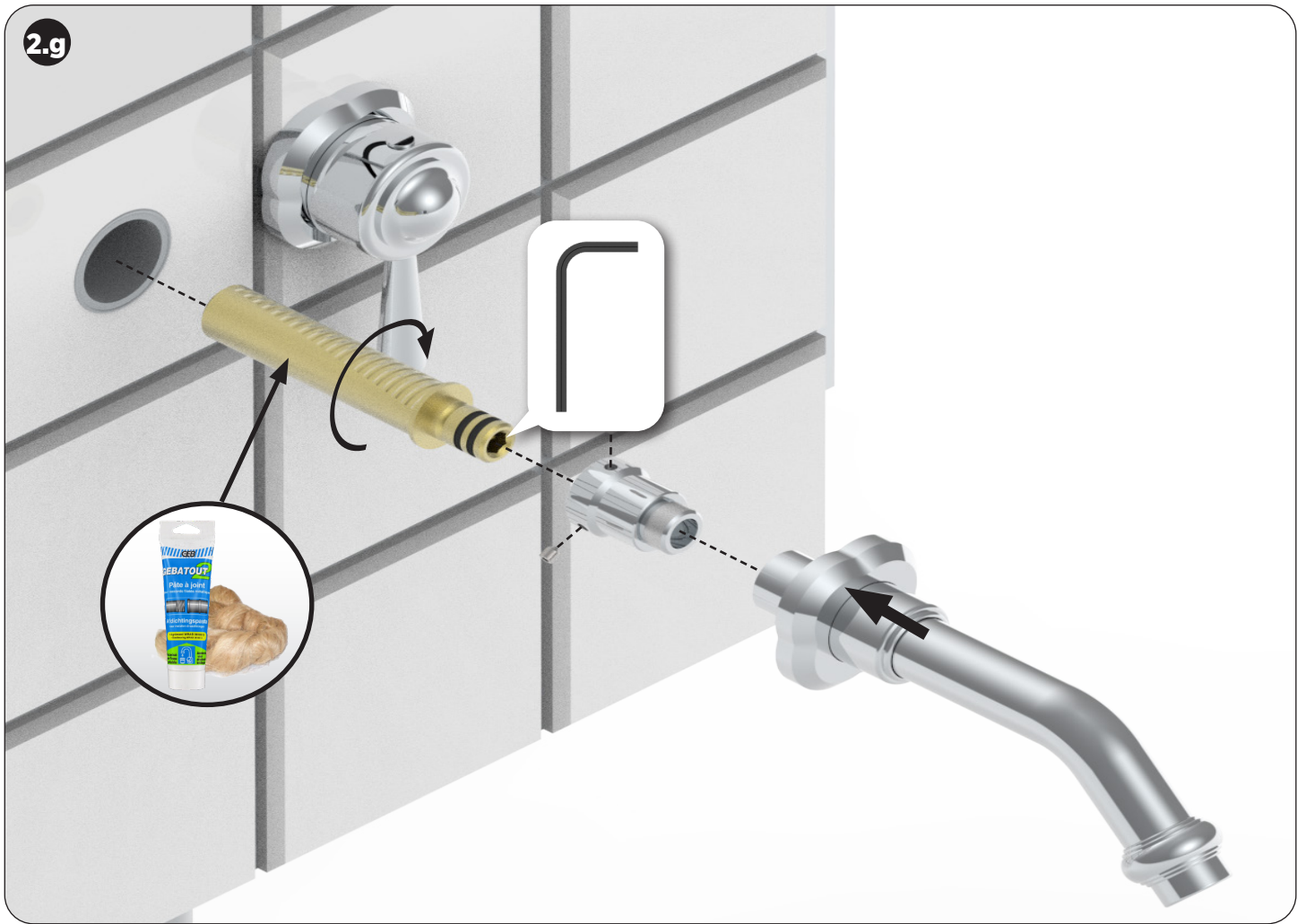

2.h

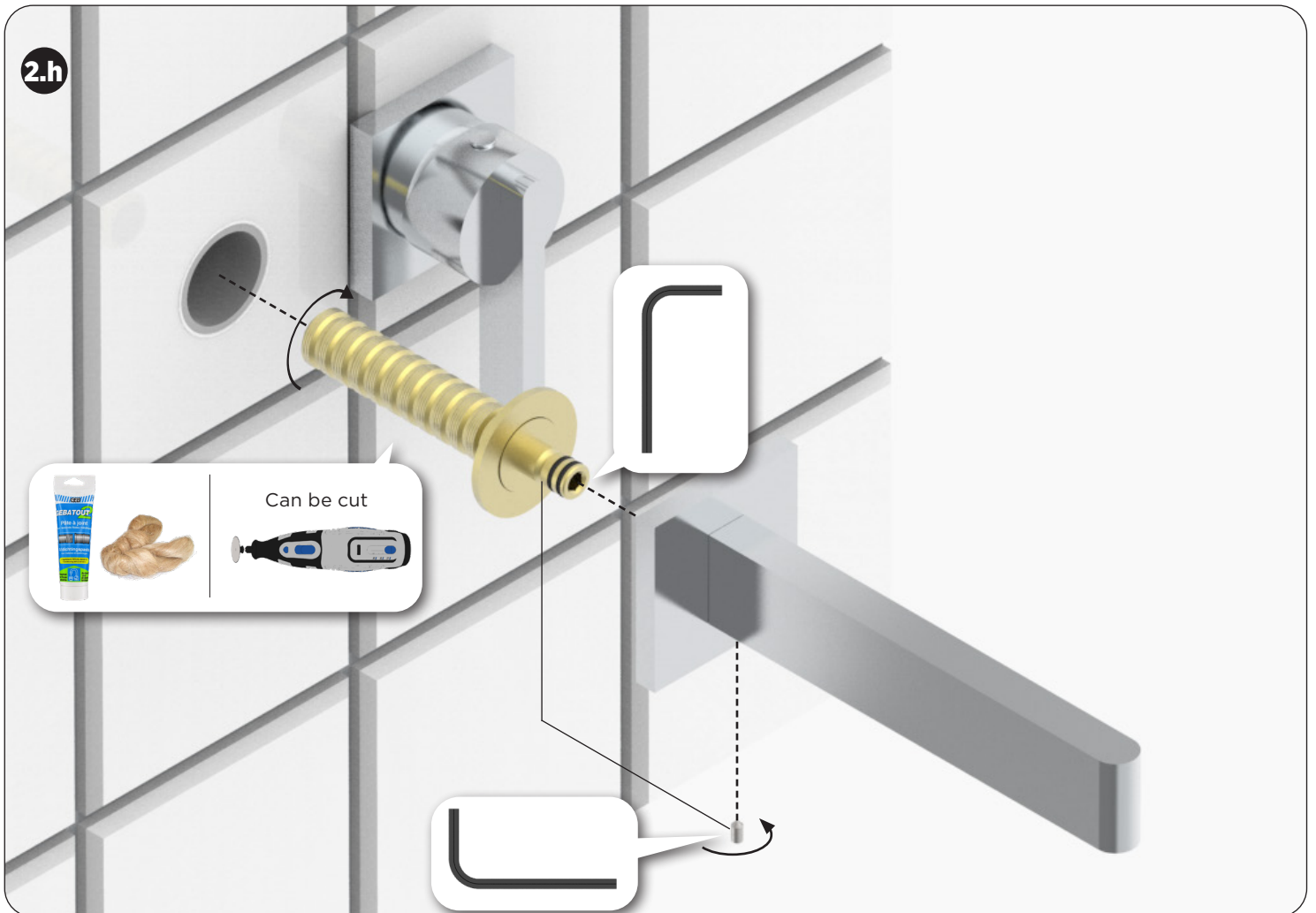

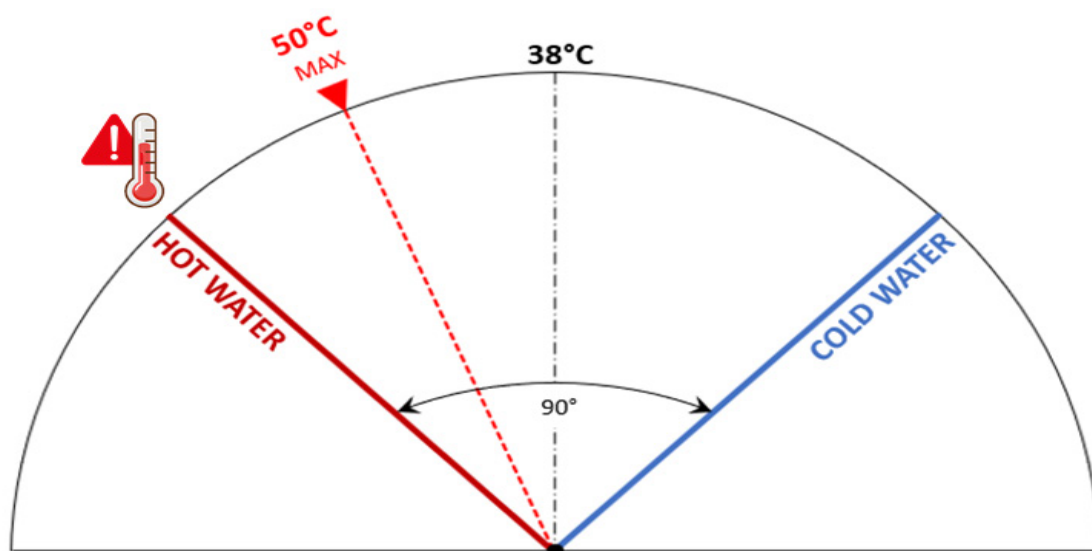
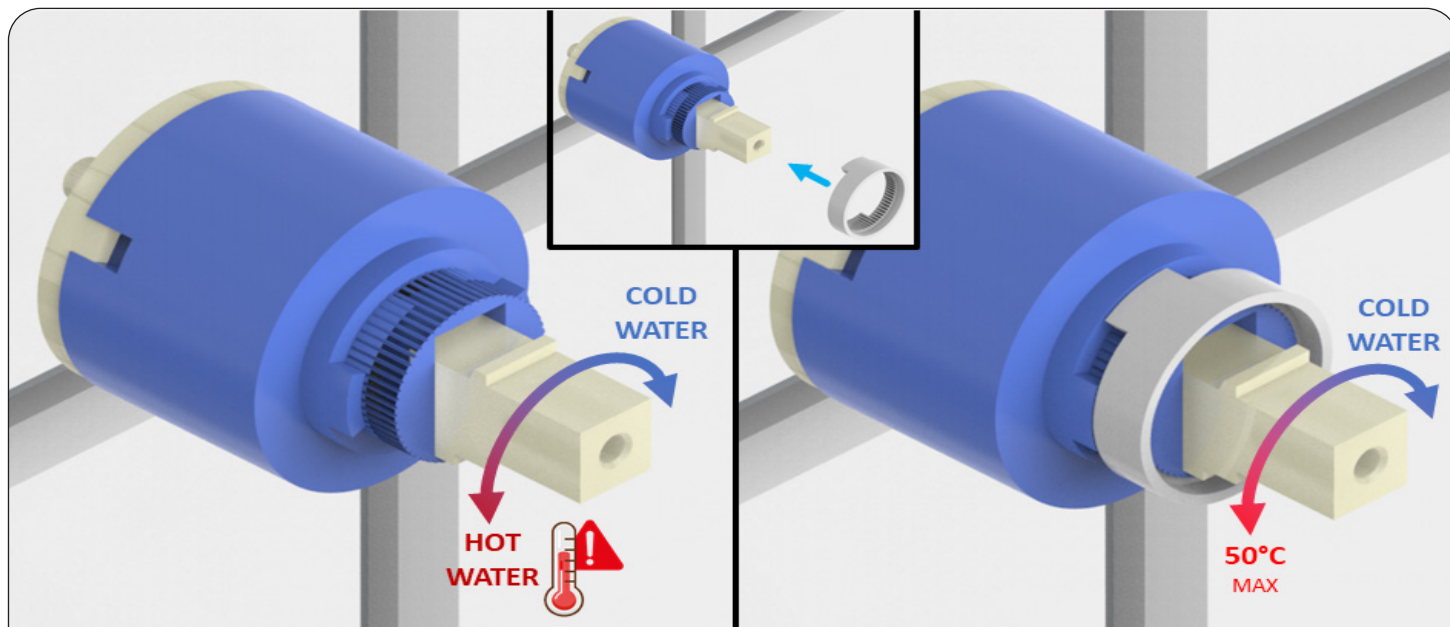

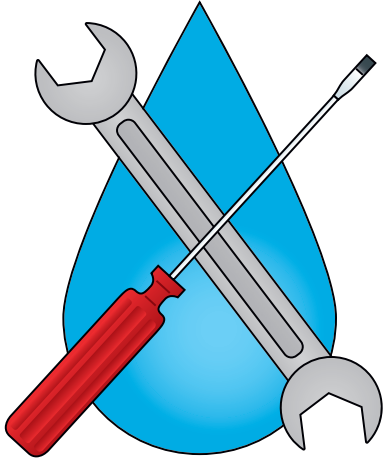

**Outils (Non-fourni)**

Tools (Not provided)

工具 (自备)

Werkzeuge

(Nicht mitgeliefert)

Herramientas (no suministradas)

Utensili (non forniti)

Gereedschap

(Niet meegeleverd)

инструменты (Не обеспечен)

الأدوات (غير مرفقة)

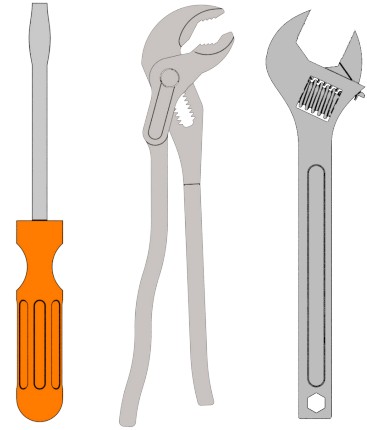

**FR** Les conditions générales de garantie, le nettoyage et l'entretien de la robinetterie apparaissent dans les conditions générales de vente.

**EN** The warranty policy, cleaning and maintenance of the valves appear in the general conditions of sale.

**CN** 质保条款，阀门的清洁和保养请参照一般销售准则

**DE** Die Garantiebedingungen, die Reinigung und die Instandhaltung der Armatur entnehmen Sie bitte den allgemeinen Geschäftsbedingungen.

**ES** Las condiciones generales de garantía, la limpieza y el mantenimiento del grifo aparecen en las condiciones generales de venta.

**IT** Le condizioni generali di garanzia, pulizia e manutenzione della rubinetteria sono indicate nelle condizioni generali di vendita.

**NL** De garantie voorwaarden, de schoonmaak en het onderhoud van de kranen worden vermeld in de algemene verkoopvoorwaarden.

**RU** Общие условия гарантии, чистка и техническое обслуживание клапанов указаны в общих условиях продажи.

**AR** تظهر الشروط العامة المتعلقة بالضمان والتنظيف وصيانة الصنبور في الشروط العامة للبيع.

**Remplacement de l'aérateur / replacement of aerator**

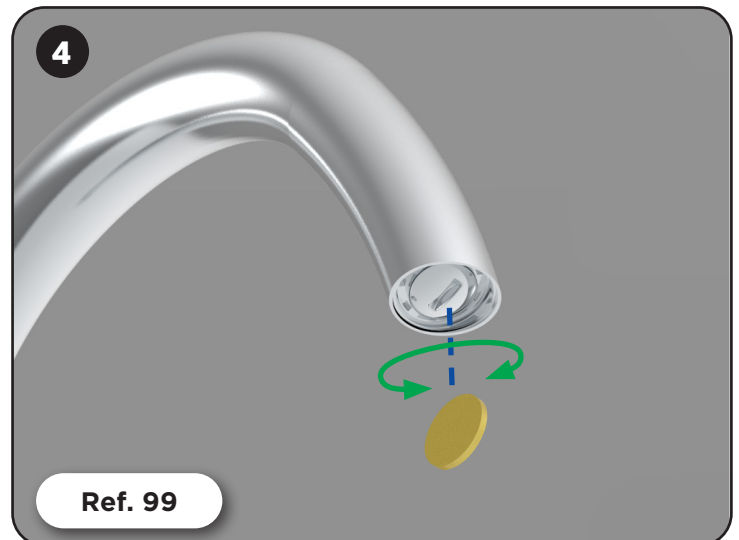
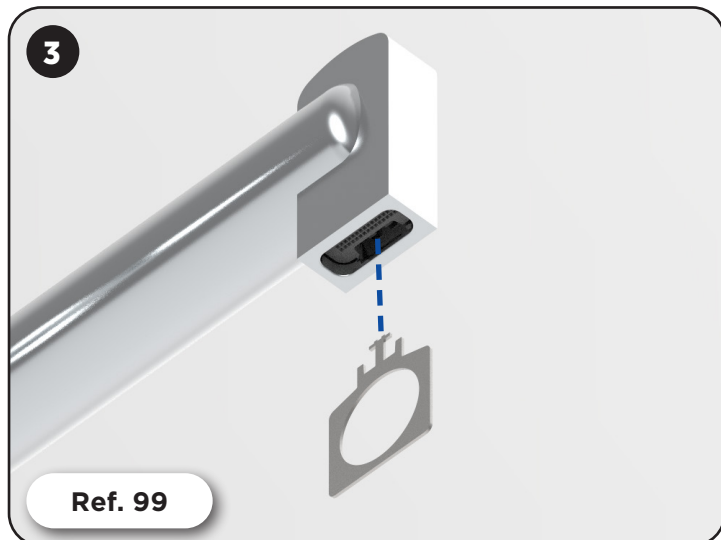
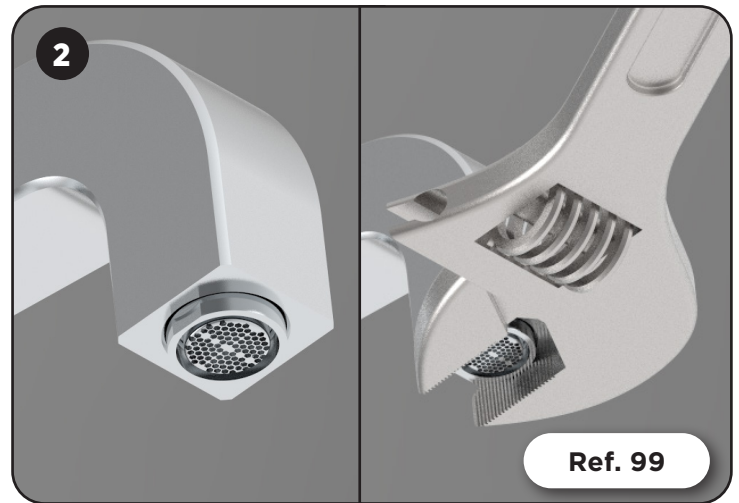
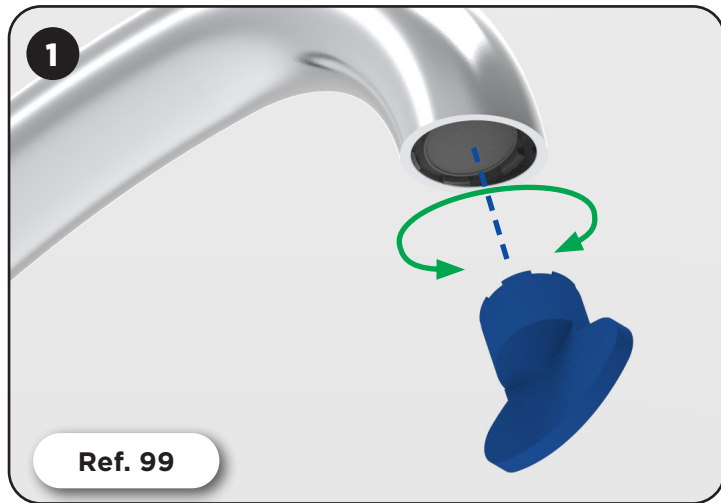

**THG**<sup>®</sup>  
P A R I S