

T O M
R O S S A U

MANUAL

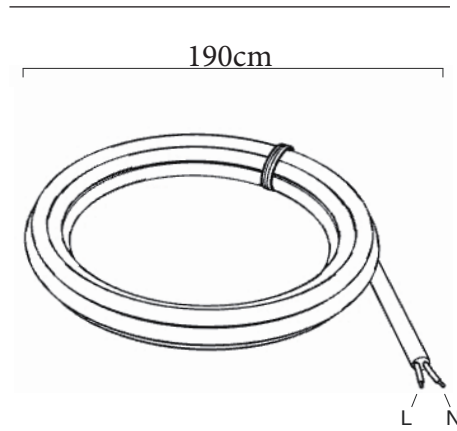

	L	N
DA	Brun	Blå
SV	Brun	Blå
EN	Brown	Blue
DE	Braün	Blau
IT	Marrone	Blu
FR	Brun	Bleu
ES	Marrón	Azul
FI	Ruskea	Sininen

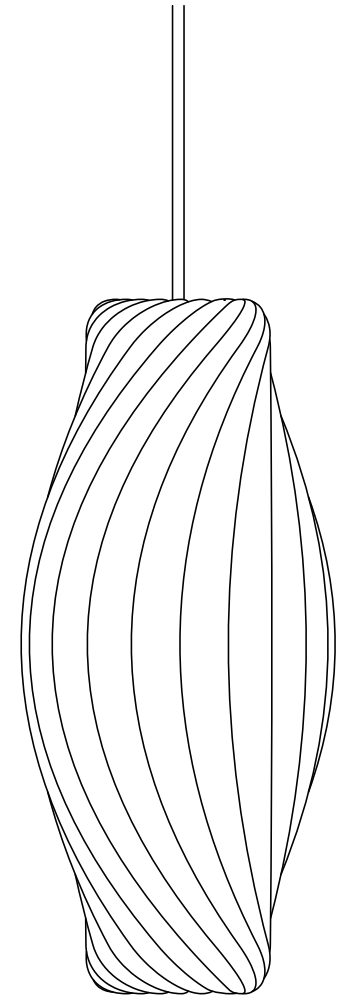
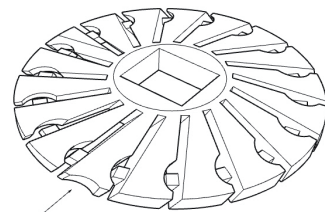

Tom Rossau A/S Frederiksberg Alle 5
1621 Copenhagen V Denmark

No.111

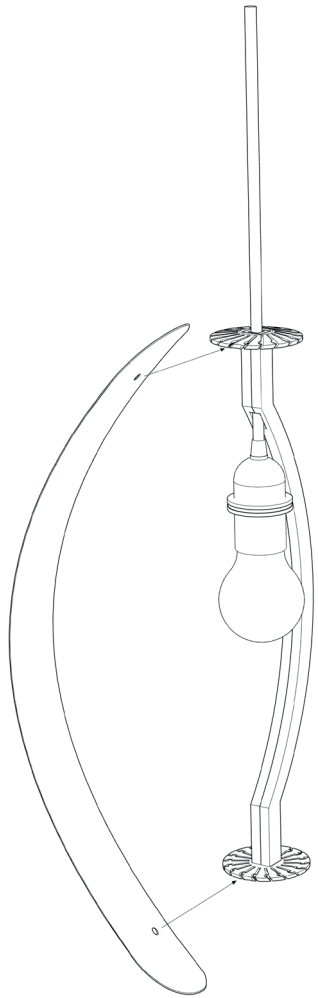

1) Remove all parts from the box and insert a lightbulb into the E14 socket

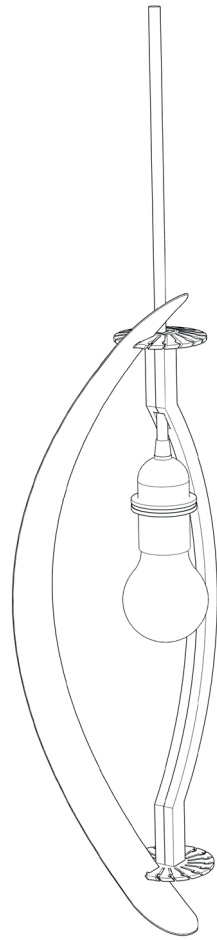

2) Start at the slits next to the indentation and attach one lamella at the time by gently sliding it into place at both ends

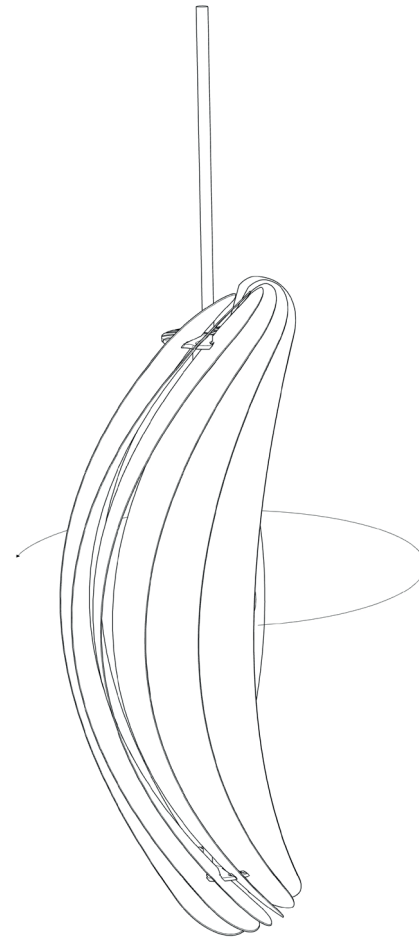

3) Repeat the process all the way around for each of the required lamellae

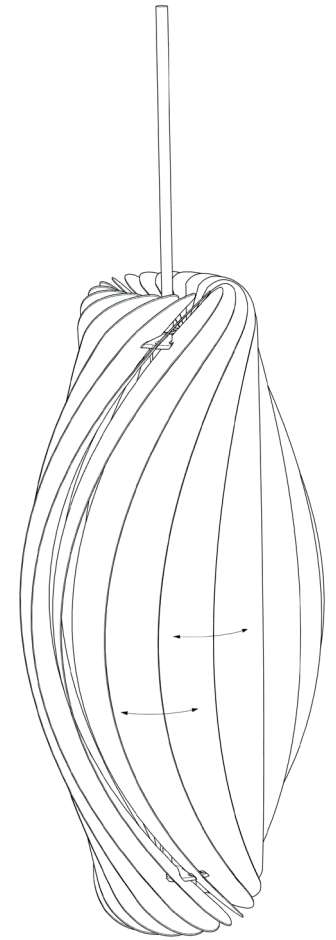

4) After installing the lamp at the desired spot, finish the lamp by leveling the space between each of the lamella