

zafferano

LAMPES A PORTER

ISTRUZIONI D'USO | INSTRUCTIONS FOR USE | GEBRAUCHSANWEISUNG |  
MODE D'EMPLOI | INSTRUCCIONES DE USO

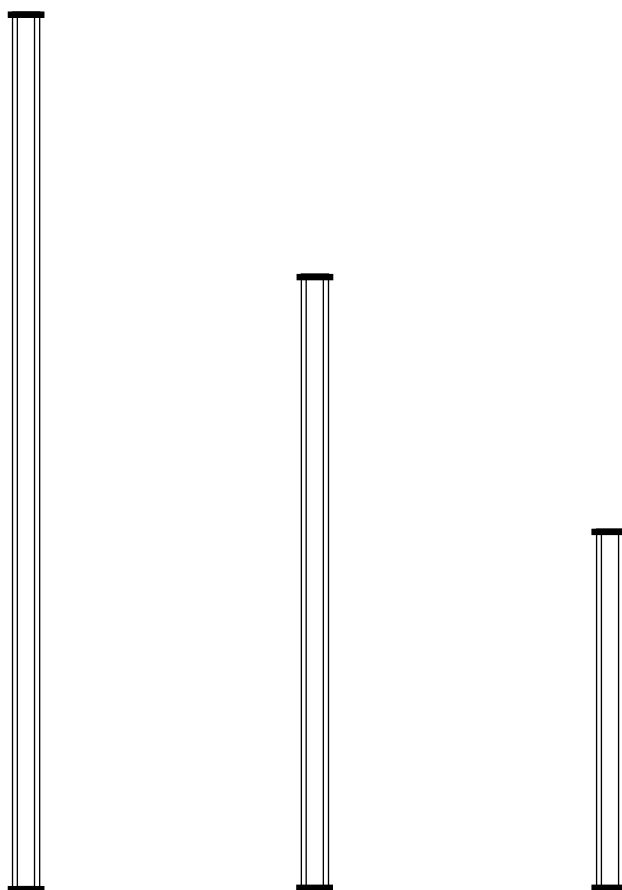





# Pencil

design Federico de Majo

Lampada ricaricabile | Rechargeable lamp | Aufladbare Lampe |  
Lampe rechargeable | Lámpara recargable



# INDICE | INDEX | ÍNDICE

	<b>IT</b>	<b>PAG</b>
	<b>Pencil LAMPADA RICARICABILE</b>	<b>1</b>
	ISTRUZIONI D'USO	2
	CONFIGURAZIONE MENU	3
	RESET DELLE IMPOSTAZIONI	3
	ISTRUZIONI DI MONTAGGIO - TAVOLO O TERRA	16
	ISTRUZIONI DI MONTAGGIO - TAVOLO	17
	ISTRUZIONI DI MONTAGGIO - SOSPENSIONE VERTICALE	18
	ISTRUZIONI DI MONTAGGIO - SOSPENSIONE ORIZZONTALE	19
	ISTRUZIONI DI MONTAGGIO - PARETE	20
	<b>EN</b>	
	<b>Pencil RECHARGEABLE LAMP</b>	<b>4</b>
	INSTRUCTIONS FOR USE	5
	CONFIGURATION MENU	6
	RESETTING THE SETTINGS	6
	ASSEMBLY INSTRUCTIONS - TABLE LAMP AND FLOOR LAMP	16
	ASSEMBLY INSTRUCTIONS - TABLE LAMP	17
	ASSEMBLY INSTRUCTIONS - VERTICAL PENDANT LAMP	18
	ASSEMBLY INSTRUCTIONS - HORIZONTAL PENDANT LAMP	19
	ASSEMBLY INSTRUCTIONS - WALL LAMP	20
	<b>DE</b>	
	<b>Pencil AUFLADBARE LAMPE</b>	<b>7</b>
	GEBRAUCHSANWEISUNG	8
	MENÜ-KONFIGURATION	9
	RESET DER EINSTELLUNGEN	9
	MONTAGEANLEITUNG - TISCH- ODER STEHLAMPE	16
	MONTAGEANLEITUNG - TISCHLAMPE	17
	IMONTAGEANLEITUNG - VERTIKALE AUFHÄNGUNG	18
	MONTAGEANLEITUNG - HORIZONTALE AUFHÄNGUNG	19
	MONTAGEANLEITUNG - WANDLAMPE	20
	<b>FR</b>	
	<b>Pencil LAMPE RECHARGEABLE</b>	<b>10</b>
	MODE D'EMPLOI	11
	CONFIGURATION MENU	12
	RÉINSTALLATION DES PARAMÈTRES	12
	INSTRUCTIONS DE MONTAGE - LAMPE DE TABLE OU DE SOL	16
	INSRUCTIONS DE MONTAGE - LAMPE DE TABLE	17
	INSTRUCTIONS DE MONTAGE - SUSPENSION VERTICALE	18
	INSTRUCTIONS DE MONTAGE - SUSPENSION HORIZONTALE	19
	INSTRUCTIONS DE MONTAGE - LAMPE MURALE	20
	<b>ES</b>	
	<b>Pencil LÁMPARA RECARGABLE</b>	<b>13</b>
	INSTRUCCIONES DE USO	14
	CONFIGURACIÓN MENÚ	15
	RESTABLECIMIENTO DE LAS CONFIGURACIONES	15
	INSTRUCCIONES DE MONTAJE - LÁMPARA DE MESA O SUELO	16
	INSTRUCCIONES DE MONTAJE - LÁMPARA DE MESA	17
	INSTRUCCIONES DE MONTAJE - SUSPENSIÓN VERTICAL	18
	INSTRUCCIONES DE MONTAJE - SUSPENSIÓN HORIZONTAL	19
	INSTRUCCIONES DE MONTAJE - LÁMPARA DE PARED	20

# Pencil

Lampada ricaricabile



**LED** 2700 - 4000K / CRI≥90 / 100-240V **IP65**

MISURE	CODICE	COLORE	WATT	LUMEN
h 146 x 5 cm / h 57,5 x 1,9 in	<b>LD0802B3</b>	bianco	LED: 16,5 MAX: 18	LED: 1860 lm (2700K) - 2100 lm (3350K) - 2340 lm (4000K) FLUSSO: 1340 lm (2700K) - 1500 lm (3350K) - 1700 lm (4000K)
	<b>LD0802N3</b>	grigio scuro		
	<b>LD0802R3</b>	corten		
h 98 x 5 cm / h 38,6 x 1,9 in	<b>LD0801B3</b>	bianco	LED: 11 MAX: 12	LED: 1240 lm (2700K) - 1400 lm (3350K) - 1570 lm (4000K) FLUSSO: 1050 lm (2700K) - 1180 lm (3350K) - 1350 lm (4000K)
	<b>LD0801N3</b>	grigio scuro		
	<b>LD0801R3</b>	corten		
h 46 x 5 cm / h 18,1 x 1,9 in	<b>LD0800B3</b>	bianco	LED: 5,5 MAX: 6	LED: 620 lm (2700K) - 700 lm (3350K) - 780 lm (4000K) FLUSSO: 530 lm (2700K) - 590 lm (3350K) - 680 lm (4000K)
	<b>LD0800N3</b>	grigio scuro		
	<b>LD0800R3</b>	corten		

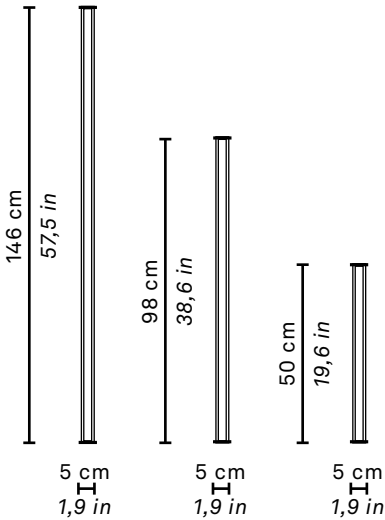

## 1. Dati tecnici:

- Volt: DC 19 V
- LED: 4014 - 3 STEP MAC ADAM
- Pacco batteria al litio inclusa: 26650 11,1 Vdc (**LD0802**-- 15000mA/H; **LD0801**-- 10000mA/H; **LD0800**-- 5000mA/H);
- Ricarica standard: 2,5A max;
- Ricarica: **LD0802**-- 12 h; **LD0801**-- 9 h; **LD0800**-- 6 h;
- Durata batteria: 100% - 8 h; 60% - 13 h; 30% - 28 h; 6% - 58 h;
- Classe: III
- Grado di protezione: IP65
- CRI≥90
- IK: 07







## 2. Carica batterie:

- Per caricare il prodotto è possibile usare un carica batterie con attacco 3,5 - 1,3; DC 19 V; 3.16A max, **NON INCLUSO**, si consiglia l'utilizzo di un caricatore certificato.
- Per un corretto caricamento della lampada si consiglia di: 1 - collegare il cavo all'adattatore; 2 - collegare il cavo alla lampada; 3 - collegare la spina alla presa elettrica; 4 - a carica completata scollegare la spina dalla presa elettrica e rimuovere il cavo.
- La lampada funziona correttamente anche se collegata alla corrente.

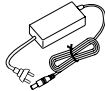
## 3. Configurazione di fabbrica:

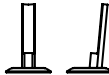
LUMINOSITÀ 100% - K 2700

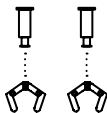
## NON INCLUSO

	<b>LD0800CS</b>	Caricabatterie con attacco 3,5 - 1,3; input:100-240V; output: DC 19 V
	<b>LD081400</b>	Base tavolo in PMMA
	<b>LD0810B3</b>	Base terra alluminio - bianco
	<b>LD0810N3</b>	Base terra alluminio - grigio scuro
	<b>LD0810R3</b>	Base terra alluminio - corten
	<b>LD0811B3</b>	Staffa sospensione verticale - bianco
	<b>LD0811N3</b>	Staffa sospensione verticale - grigio scuro
	<b>LD0811R3</b>	Staffa sospensione verticale - corten
	<b>LD0812B3</b>	Staffe sospensione orizzontale - bianco
	<b>LD0812N3</b>	Staffe sospensione orizzontale - grigio scuro
	<b>LD0812R3</b>	Staffe sospensione orizzontale - corten
	<b>LD0813B3</b>	Staffe parete alluminio - bianco
	<b>LD0813N3</b>	Staffe parete alluminio - grigio scuro
	<b>LD0813R3</b>	Staffe parete alluminio - corten

LED NON SOSTITUIBILE



Visita il nostro sito per ulteriori informazioni, e aggiornamenti sulle caratteristiche del prodotto.

DESIGNED BY ZAFFERANO SRL IN ITALY, MADE IN PRC.

Zafferano srl, Viale dell'Industria, 26 - 31055 Quinto di Treviso - TV - Italia

www.zafferanoitalia.com



#### 4. Consigli d'uso:

Questo prodotto serve esclusivamente a scopi di illuminazione e:

A) Non deve essere esposto a pesanti carichi meccanici o forti contaminazioni; B) può essere installato e usato solo previo controllo delle condizioni del prodotto; verificare che non risulti sporco e non abbia subito danneggiamenti durante lo stoccaggio; C) l'installazione e la manutenzione vanno eseguite ad apparecchio spento; D) modifiche o manomissioni del prodotto e il non rispetto delle indicazioni riportate possono rendere l'apparecchio pericoloso; E) i prodotti con grado di protezione 65 (IP65) sono idonei per uso esterno; F) per la pulizia di tutte le superfici metalliche e plastiche utilizzare un panno morbido asciutto; G) La ditta Zafferano declina ogni responsabilità per danni causati da un proprio prodotto montato in modo non conforme alle istruzioni.

#### 5. Attenzione:

- Il piano d'appoggio della lampada non deve superare i 15° di inclinazione o rischia la caduta.
- La batteria è fornita delle seguenti protezioni: cortocircuito, sovra scarica, sovralimentazione, sovracorrente, sovratensione.
- Per preservare l'integrità della batteria si consiglia di mantenere la carica tra il 20% minimo e 80% massimo; se la lampada non viene utilizzata per lunghi periodi, si consiglia di procedere periodicamente ad un ciclo di carica/scarica del prodotto.
- Si prega di fare riferimento alle leggi locali per un corretto smaltimento e riciclaggio della batteria.

## ISTRUZIONI D'USO

### Accensione / dimmerazione / spegnimento

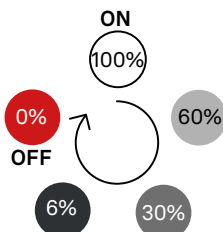
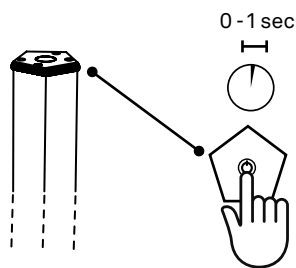

Rapidi tocchi per:

- accendere
  - cambiare la luminosità
  - spegnere il dispositivo
- La ripetizione degli step è ciclica.

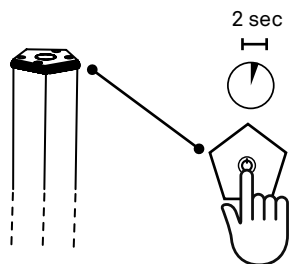

Tenendo premuto il touch per due secondi, la lampada si spegne memorizzando lo step di dimmerazione corrente e riproponendolo all'accensione successiva.

### TEMPERATURA COLORE

0 - 5 sec



2700K

5 - 10 sec



3350K

10 - 15 sec



4000K

Da lampada spenta, tenere premuto il touch:

- dopo 5 secondi si accende a 2700K
  - dopo 10 secondi passa a 3350K
  - dopo 15 secondi passa a 4000K
- La ripetizione degli step è ciclica.

Interrompendo il tocco durante una delle fasi, la lampada memorizza l'impostazione della fase corrente.

Visita il nostro sito per ulteriori informazioni, e aggiornamenti sulle caratteristiche del prodotto.

DESIGNED BY ZAFFERANO SRL IN ITALY, MADE IN PRC.

Zafferano srl, Viale dell'Industria, 26 - 31055 Quinto di Treviso - TV - Italia

[www.zafferanoitalia.com](http://www.zafferanoitalia.com)

## LED DI SEGNALAZIONE

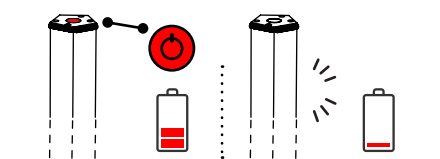

LED ROSSO FISSO: carica della batteria inferiore al 20% si consiglia la ricarica

Quando la carica è esaurita (1%), la lampada non si accende, ma emette tre flash bianchi di allerta - ricaricare

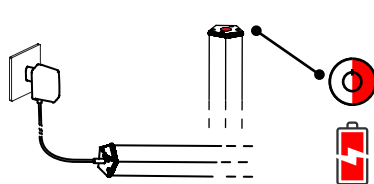

LED ROSSO LAMPEGGIANTE  
ricarica in corso

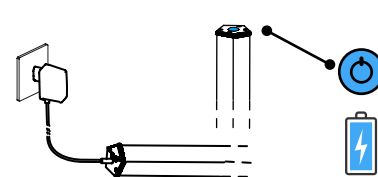

LED BLU FISSO  
batteria carica al 100% si consiglia di  
disconnettere dall'unità di ricarica

## RESET DELLE IMPOSTAZIONI Ripristino della configurazione di fabbrica

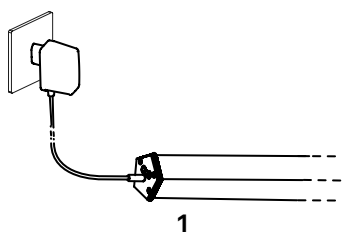

1  
Collegare la lampada alla  
presa di corrente

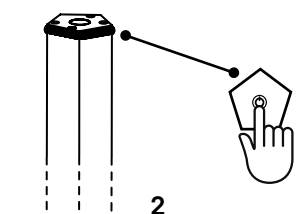

2  
Appoggiare il dito sul touch  
mantenendo la pressione

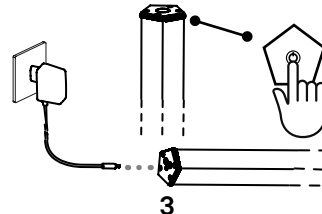

3  
Scollegare la lampada dalla  
presa di corrente

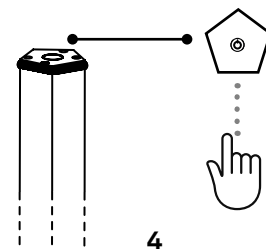

4  
Sollevare il dito dal touch

Visita il nostro sito per ulteriori informazioni, e aggiornamenti sulle caratteristiche del prodotto.

DESIGNED BY ZAFFERANO SRL IN ITALY, MADE IN PRC.

Zafferano srl, Viale dell'Industria, 26 - 31055 Quinto di Treviso - TV - Italia

[www.zafferanoitalia.com](http://www.zafferanoitalia.com)



# Pencil

Rechargeable lamp

LED 2700 - 4000K / CRI≥90 / 100-240V P65

MEASURE	CODE	COLOUR	WATT	LUMEN
h 146 x 5 cm / h 57,5 x 1,9 in	LD0802B3	white	LED: 16,5 MAX: 18	LED: 1860 lm (2700K) - 2100 lm (3350K) - 2340 lm (4000K) LAMP: 1340 lm (2700K) - 1500 lm (3350K) - 1700 lm (4000K)
	LD0802N3	dark grey		
	LD0802R3	corten		
h 98 x 5 cm / h 38,6 x 1,9 in	LD0801B3	white	LED: 11 MAX: 12	LED: 1240 lm (2700K) - 1400 lm (3350K) - 1570 lm (4000K) LAMP: 1050 lm (2700K) - 1180 lm (3350K) - 1350 lm (4000K)
	LD0801N3	dark grey		
	LD0801R3	corten		
h 46 x 5 cm / h 18,1 x 1,9 in	LD0800B3	white	LED: 5,5 MAX: 6	LED: 620 lm (2700K) - 700 lm (3350K) - 780 lm (4000K) LAMP: 530 lm (2700K) - 590 lm (3350K) - 680 lm (4000K)
	LD0800N3	dark grey		
	LD0800R3	corten		

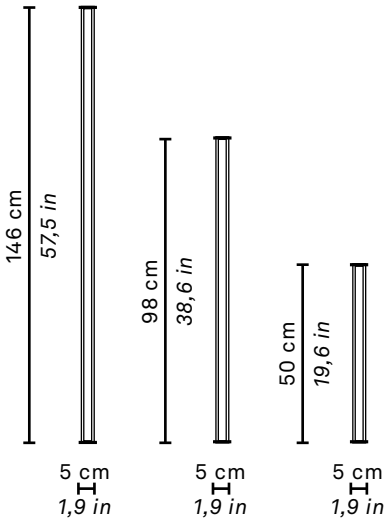

### 1. Technical data:

- Volt: DC 19 V
- LED: 4014 - 3 STEP MAC ADAM
- Lithium battery pack included: 26650 11,1 Vdc (LD0802-- 15000mA/H; LD0801-- 10000mA/H; LD0800-- 5000mA/H);
- Standard charge: 2.5A max
- Charge: LD0802-- 12 h; LD0801-- 9 h; LD0800-- 6 h;
- Battery life: 100% 8 h - 60% 13 h - 30% 28 h - 6% 58 h
- Class: III
- Protection rating: IP65
- CRI≥90
- IK: 07

### 2. Charger:

- To recharge the product, you can use a battery charger with a 3.5 1.3 connector; DC 19 V; 3.16A max, NOT INCLUDED. We recommend using a certified charger.
- To correctly charge the lamp, we recommend that you: 1- Connect the cable to the adaptor; 2- Connect the cable to the lamp; 3- Put the plug into the electrical socket; 4- When fully charged, disconnect the plug from the electrical socket and remove the cable.
- The lamp also operates properly when connected to the mains power supply.

### 4. Manufacturer's configuration:

100% LUMINOSITY - 2700K

### NOT INCLUDED

	LD0800CS	Battery charger with a 3.5 - 1.3 connector; input:100-240V; output: DC 19 V
	LD081400	Base for table lamp in PMMA
	LD0810B3	Base for table lamp or floor lamp in aluminium - white
	LD0810N3	Base for table lamp or floor lamp in aluminium - dark grey
	LD0810R3	Base for table lamp or floor lamp in aluminium - corten
	LD0811B3	Bracket for vertical pendant lamp in aluminium - white
	LD0811N3	Bracket for vertical pendant lamp in aluminium - dark grey
	LD0811R3	Bracket for vertical pendant lamp in aluminium - corten
	LD0811B3	Bracket for horizontal pendant lamp in aluminium - white
	LD0811N3	Bracket for horizontal pendant lamp in aluminium - dark grey
	LD0811R3	Bracket for horizontal pendant lamp in aluminium - corten
	LD0813B3	Bracket for wall lamp in aluminium - white
	LD0813N3	Bracket for wall lamp in aluminium - dark grey
	LD0813R3	Bracket for wall lamp in aluminium - corten

NON-REPLACEABLE LED



For more information and updates visit our website  
DESIGNED BY ZAFFERANO SRL IN ITALY, MADE IN PRC.

Zafferano srl, Viale dell'Industria, 26 - 31055 Quinto di Treviso - TV - Italy  
www.zafferanoitalia.com



#### 4. Tips for use:

This product is exclusively for lighting purposes and:

- A) It must not be exposed to heavy mechanical loads or contamination;
- B) It can be installed and used only after checking the state of the product; check that is not dirty and has not been damaged during storage;
- C) Installation and maintenance must be carried out when the appliance is switched off;
- D) Any alterations to the product, any tampering and any failure to comply with the instructions provided may make the appliance hazardous;
- E) Products with IP65 protection are suitable for outdoor use;
- F) All metal and plastic surfaces should be cleaned with a soft dry cloth;
- G) The company Zafferano shall not be held liable for any damage caused due to its products being assembled in any manner that does not comply with the instructions provided.

#### 5. Important!

- The support surface for the lamp must not exceed a 15° tilt or it will fall.
- The battery is provided with the following protection functions: short circuit, over discharge, over charge, over current, over voltage.
- To preserve the integrity of the battery, we recommend keeping the charge between minimum 20% and maximum 80%; if the lamp is not used for long periods, it is advisable to regularly charge/discharge the product.
- Please refer to local laws for the proper disposal and recycling of the battery.

## INSTRUCTIONS FOR USE

### Switching on / dimming / switching off

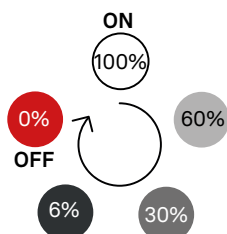
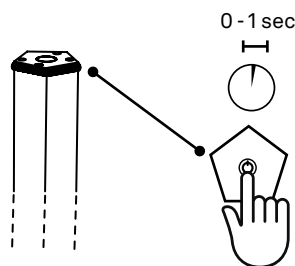

Quick taps to:

- turn on
- change the brightness
- turn off the lamp

The steps are repeated in a cycle.

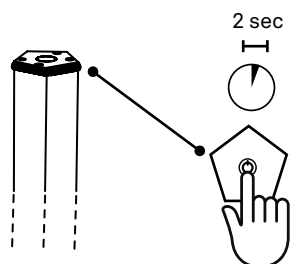

When you press and hold the touch button for two seconds, the lamp turns off, memorising the current dimmer setting and proposing it again the next time the lamp is turned on.

### COLOR TEMPERATURE

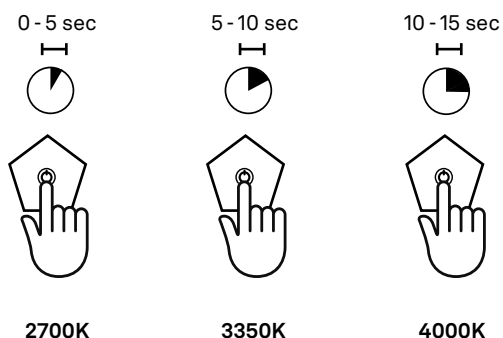

When the lamp is turned off, press and hold the touch button:

- after 5 seconds it turns on at 2700K
  - after 10 seconds it switches to 3350K
  - after 15 seconds it switches to 4000K
- The steps are repeated in a cycle.

If you release your touch during one of the steps, the lamp memorises the setting of the current step.



## INDICATOR LEDS

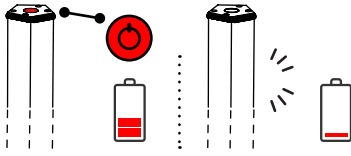

**PERMANENT RED LED**  
the battery charge is lower than 20%,  
charging is recommended.  
When the charge is depleted (1%), the  
lamp does not switch on but emits three  
white flashes as an alert to charge

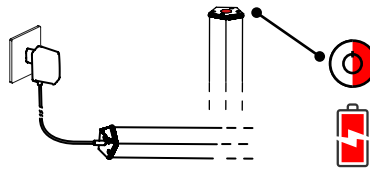

**FLASHING RED LED**  
charging in progress

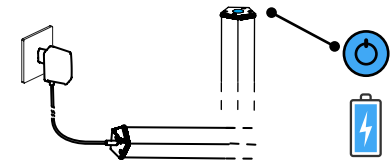

**PERMANENT BLUE LED**  
the battery is 100% charged,  
disconnection from the power charger  
is recommended

## RESETTING THE SETTINGS

Restoring the manufacturer's setting

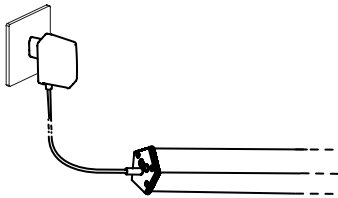

1

Plug the lamp into the  
electric socket

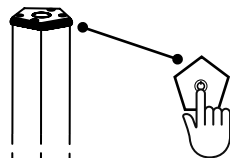

2

Place a finger on the touch  
sensor and keep it pressed  
down

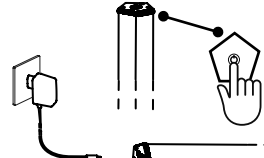

3

Unplug the lamp from the  
electric socket

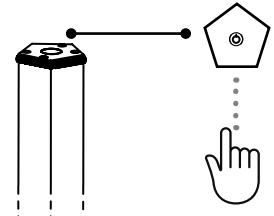

4

Remove your finger from the  
touch sensor



# Pencil

## Aufladbare Lampe



**LED** 2700 - 4000K / CRI≥90 / 100-240V **IP65**

ABMESSUNGEN	CODE	FARBE	WATT	LUMEN
h 146 x 5 cm / h 57,5 x 1,9 in	LD0802B3	weiß	LED: 16,5 MAX: 18	LED: 1860 lm (2700K) - 2100 lm (3350K) - 2340 lm (4000K) LAMP: 1340 lm (2700K) - 1500 lm (3350K) - 1700 lm (4000K)
	LD0802N3	dunkelgrau		
	LD0802R3	corten		
h 98 x 5 cm / h 38,6 x 1,9 in	LD0801B3	weiß	LED: 11 MAX: 12	LED: 1240 lm (2700K) - 1400 lm (3350K) - 1570 lm (4000K) LAMP: 1050 lm (2700K) - 1180 lm (3350K) - 1350 lm (4000K)
	LD0801N3	dunkelgrau		
	LD0801R3	corten		
h 46 x 5 cm / h 18,1 x 1,9 in	LD0800B3	weiß	LED: 5,5 MAX: 6	LED: 620 lm (2700K) - 700 lm (3350K) - 780 lm (4000K) LAMP: 530 lm (2700K) - 590 lm (3350K) - 680 lm (4000K)
	LD0800N3	dunkelgrau		
	LD0800R3	corten		

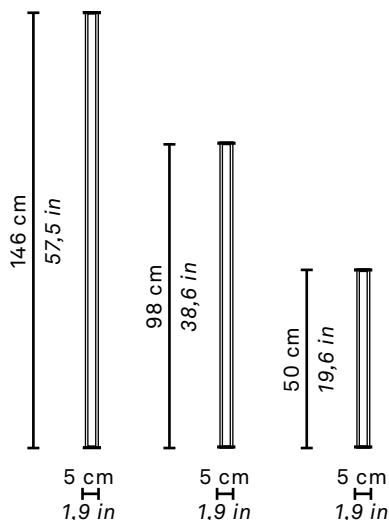

### 1. Technische Daten:

- Volt: DC 19 V
- LED: 4014 - 3 STEP MAC ADAM
- Eine Lithiumbatterie ist in der Lieferung enthalten: 26650 11,1 Vdc (LD0802-- 15000mA/H; LD0801-- 10000mA/H; LD0800-- 5000mA/H);
- Standardaufladung: 2.5A max
- Aufladezeit: LD0802-- 12 Std ; LD0801-- 9 Std ; LD0800-- 6 Std ;
- Batteriedauer: 100% 8 Std - 60% 13 Std - 30% 28 Std - 6% 58 Std
- Klasse: III
- Schutzgrad: IP65
- CRI≥90
- IK: 07

### 2. Ladegerät:

- Zum Aufladen des Produkts kann ein Ladegerät verwendet werden, mit: 3,5 - 1,3-Anschluss; DC 19 V; 3.16A max. NICHT ENTHALTEN. Wir empfehlen die Verwendung eines zertifizierten Ladegeräts.
- Um die Lampe korrekt aufzuladen, sollte man: 1- Das Kabel an den Adapter anschließen; 2- Das Kabel an die Lampe anschließen; 3- Den Stecker in die Steckdose stecken; 4- Wenn die Lampe aufgeladen ist, den Stecker aus der Steckdose ziehen und das Kabel von der Lampe trennen.
- Die Lampe funktioniert auch mit Stromanschluss korrekt.

### 3. Werkskonfiguration:

HELLIGKEIT 100% - K 2700

### NICHT ENTHALTEN

	LD0800CS	Ladegerät mit 3,5 - 1,3-Anschluss; input:100-240V; output: DC 19 V
	LD081400	Tischlampenfuß aus PMMA
	LD0810B3	Tischlampen- oder Stehlampenfuß aus Aluminium - weiß
	LD0810N3	Tischlampen- oder Stehlampenfuß aus Aluminium - dunkelgrau
	LD0810R3	Tischlampen- oder Stehlampenfuß aus Aluminium - corten
	LD0811B3	Vertikaler Aufhängebügel aus Aluminium - weiß
	LD0811N3	Vertikaler Aufhängebügel aus Aluminium - dunkelgrau
	LD0811R3	Vertikaler Aufhängebügel aus Aluminium - corten
	LD0812B3	Horizontale Aufhängebügel aus Aluminium - weiß
	LD0812N3	Horizontale Aufhängebügel aus Aluminium - dunkelgrau
	LD0812R3	Horizontale Aufhängebügel aus Aluminium - corten
	LD0813B3	Aluminium-Wandhalterungen - weiß
	LD0813N3	Aluminium-Wandhalterungen - dunkelgrau
	LD0813R3	Aluminium-Wandhalterungen - corten

LED NICHT AUSTAUSCHBAR



Zu weiteren Informationen und Aktualisierungen der Produktkennzeichen besuchen Sie bitte unsere Webseite.

DESIGNED BY ZAFFERANO SRL IN ITALY, MADE IN PRC.

Zafferano srl, Viale dell'Industria, 26 - 31055 Quinto di Treviso - TV - Italien

www.zafferanoitalia.com



#### 4. Hinweise zur Verwendung:

Dieses Produkt dient ausschließlich zur Beleuchtung und:

- A) Darf keinen starken mechanischen Belastungen oder starken Kontaminationen ausgesetzt werden; B) kann nur, nachdem der Zustand des Produkts kontrolliert wurde, installiert und verwendet werden; prüfen, dass es nicht schmutzig ist und während der Lagerung nicht beschädigt wurde; C) Das Gerät muss ausgeschaltet, installiert oder gewartet werden; D) Durch die Veränderung oder Manipulation des Produkts und die Nichteinhaltung dieser Anweisungen kann das Gerät gefährlich werden; E) Produkte mit Schutzgrad 65 (IP65) können im Freien verwendet werden; F) Zur Reinigung aller Metall- oder Plastikoberflächen ein trockenes, weiches Tuch verwenden; G) Die Firma Zafferano lehnt jede Verantwortung für Schäden ab, die durch eines ihrer Produkte, das nicht gemäß der gelieferten Anweisungen montiert wurde, entstehen.

#### 5. Achtung:

- Die Standfläche der Lampe darf keine höhere Neigung als 15° besitzen, sonst fällt diese um.
- Die Batterie ist abgesichert gegen: Kurzschluss, Überentlastung, Überbelastung, Überstrom, Überspannung.
- Um die Lebensdauer des Akkus zu erhalten, sollte sein Ladestand zwischen 20 und 80 Prozent liegen. Wenn die Lampe lange Zeit nicht benutzt wird, sollte der Akku regelmäßig ent- und wieder aufgeladen werden.
- Die Batterie muss entsprechend der geltenden, lokalen Vorschriften zur Abfallentsorgung und -wiederverwertung behandelt werden.

## GEBRAUCHSANWEISUNG

### Ein- / Dimmen / Ausschalten

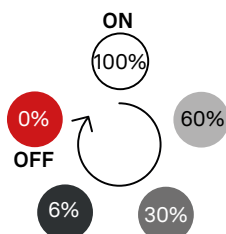
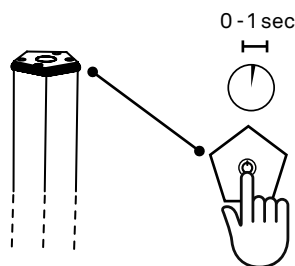

Kurz drücken, zum:

- Einschalten
- Helligkeit anpassen
- Gerät ausschalten

Die Aufeinanderfolge ist zyklisch.

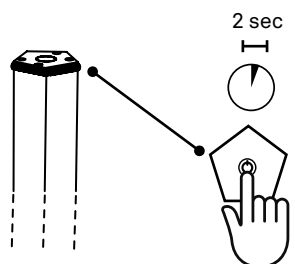

Wenn Sie den Berührungsschalter zwei Sekunden lang gedrückt halten, schaltet sich die Lampe aus, speichert die aktuelle Dimmstufe und geht beim nächsten Einschalten mit dieser wieder an.

## FARBTEMPERATUR

0 - 5 sec



2700K

5 - 10 sec



3350K

10 - 15 sec



4000K

Halten Sie den Berührungsschalter bei ausgeschalteter Lampe gedrückt:

- nach 5 Sekunden geht sie bei 2700K an
- nach 10 Sekunden schaltet sie auf 3350K
- nach 15 Sekunden schaltet sie auf 4000K

Die Aufeinanderfolge ist zyklisch.  
Wird der Berührungsschalter während einer der Phasen losgelassen, speichert die Lampe die aktuelle Einstellung.

Zu weiteren Informationen und Aktualisierungen der Produktkennzeichen besuchen Sie bitte unsere Webseite.

DESIGNED BY ZAFFERANO SRL IN ITALY, MADE IN PRC.

Zafferano srl, Viale dell'Industria, 26 - 31055 Quinto di Treviso - TV - Italien

[www.zafferanoitalia.com](http://www.zafferanoitalia.com)

## LEDANZEIGE

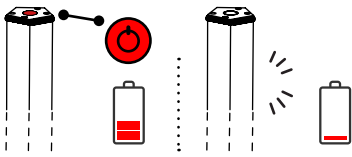

**LED LEUCHTET ROT**  
Batterieladung unter 20%. Die Batterie sollte aufgeladen werden  
Wenn die Batterie entladen ist (1%), geht die Lampe nicht an, blinkt aber dreimal weiß auf - aufladen

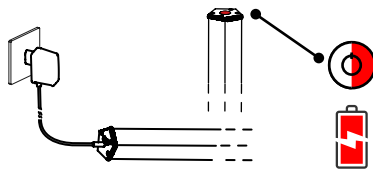

**LED BLINKT ROT**  
Wird aufgeladen

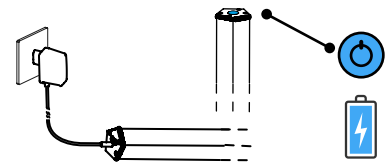

**LED LEUCHTET BLAU**  
Batterie zu 100% aufgeladen.  
Die Batterie vom Ladegerät trennen

## RESET DER EINSTELLUNGEN

Wiederherstellung der Werkskonfiguration

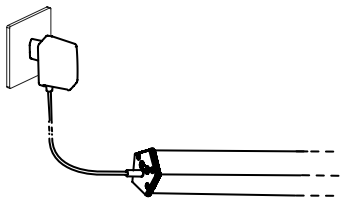

**1**  
Den Stecker der Lampe in die Steckdose stecken

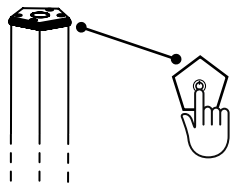

**2**  
Mit dem Finger auf das Touchfeld drücken

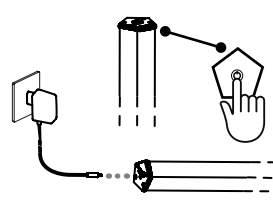

**3**  
Den Stecker der Lampe aus der Steckdose ziehen

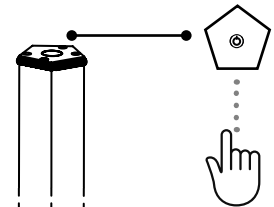

**4**  
Den Finger vom Touchfeld nehmen



# Pencil

Lampe rechargeable

LED 2700 - 4000K / CRI≥90 / 100-240V IP65

MISURE	CODE	COULEUR	WATT	LUMEN
h 146 x 5 cm / h 57,5 x 1,9 in	LD0802B3	blanc	LED: 16,5 MAX: 18	LED: 1860 lm (2700K) - 2100 lm (3350K) - 2340 lm (4000K) FLUX: 1340 lm (2700K) - 1500 lm (3350K) - 1700 lm (4000K)
	LD0802N3	gris foncé		
	LD0802R3	corten		
h 98 x 5 cm / h 38,6 x 1,9 in	LD0801B3	blanc	LED: 11 MAX: 12	LED: 1240 lm (2700K) - 1400 lm (3350K) - 1570 lm (4000K) FLUX: 1050 lm (2700K) - 1180 lm (3350K) - 1350 lm (4000K)
	LD0801N3	gris foncé		
	LD0801R3	corten		
h 46 x 5 cm / h 18,1 x 1,9 in	LD0800B3	blanc	LED: 5,5 MAX: 6	LED: 620 lm (2700K) - 700 lm (3350K) - 780 lm (4000K) FLUX: 530 lm (2700K) - 590 lm (3350K) - 680 lm (4000K)
	LD0800N3	gris foncé		
	LD0800R3	corten		

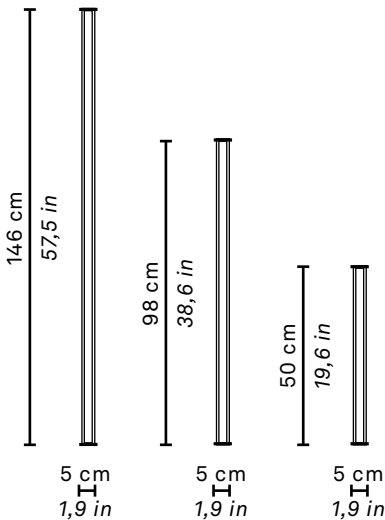

### 1. Données techniques:

- Voltage: DC 19 V
- LED: 4014 - 3 STEP MAC ADAM
- Batteries au lithium inclus: 26650 11,1 Vdc (LD0802-- 15000mA/H; LD0801-- 10000mA/H; LD0800-- 5000mA/H);
- Standard recharge: 2,5A max;
- Recharge: LD0802-- 12 h; LD0801-- 9 h; LD0800-- 6 h;
- Durée de la batterie: 100% 8 h - 60% 13 h - 30% 28 h - 6% 58 h
- Classe: III
- Degré de protection: IP65
- CRI≥90
- IK: 07











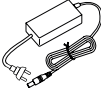

### 2. Chargeur de batterie:

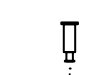
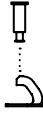
- Pour recharger le produit, il est possible d'utiliser un chargeur de batterie avec une attache 3,5 - 1,3; DC 19 V; 3.16A max, NON INCLUS, il est conseillé d'utiliser un chargeur certifié.
- Pour recharger la lampe correctement, il est conseillé de: 1- brancher le câble à l'adaptateur; 2- brancher le câble à la lampe; 3- insérer la fiche dans la prise de courant; 4- lorsque la lampe est rechargée, retirer la fiche de la prise de courant et enlever le câble.
- La lampe fonctionne correctement, même si elle est raccordée au courant.

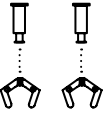
### 3. Configuration d'usine:

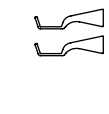
LUMINOSITE 100% - K 2700

### NON INCLUS

	<b>LD0800CS</b> Chargeur de batterie avec attache 3,5 - 1,3; input:100-240V; output: DC 19 V
	<b>LD081400</b> Base pour table en PMMA
	<b>LD0810B3</b> Base pour table ou pour sol en aluminium - blanc
	<b>LD0810N3</b> Base pour table ou pour sol en aluminium - gris foncé
	<b>LD0810R3</b> Base pour table ou pour sol en aluminium - corten
	<b>LD0811B3</b> Etrier pour suspension verticale en aluminium - blanc
	<b>LD0811N3</b> Etrier pour suspension verticale en aluminium - gris foncé
	<b>LD0811R3</b> Etrier pour suspension verticale en aluminium - corten
	<b>LD0812B3</b> Etriers pour suspension horizontale en aluminium - blanc
	<b>LD0812N3</b> Etriers pour suspension horizontale en aluminium - gris foncé
	<b>LD0812R3</b> Etriers pour suspension horizontale en aluminium - corten
	<b>LD0813B3</b> Etriers pour fixation murale en aluminium - blanc
	<b>LD0813N3</b> Etriers pour fixation murale en aluminium - gris foncé
	<b>LD0813R3</b> Etriers pour fixation murale en aluminium - corten

LED NON REMPLAÇABLE



Visitez notre site pour recevoir d'autres informations et des mises à jour sur les caractéristiques du produit

DESIGNED BY ZAFFERANO SRL IN ITALY, MADE IN PRC.

Zafferano srl, Viale dell'Industria, 26 - 31055 Quinto di Treviso - TV - Italie

www.zafferanoitalia.com



#### 4. Conseils d'utilisation:

Ce produit sert exclusivement pour éclairer et:

- A) Ne doit pas être exposé à de lourdes charges mécaniques ou à de fortes contaminations; B) Peut être installé et utilisé uniquement après avoir contrôlé les conditions du produit; vérifier s'il n'est pas sale et s'il n'a pas subi de dommages durant le stockage; C) L'installation et l'entretien doivent être effectués lorsque l'appareil est éteint; D) Les modifications ou les altérations du produit et le non-respect des indications fournies peuvent rendre l'appareil dangereux; E) Les produits avec un degré de protection 65 (IP65) sont adaptés à une utilisation externe; F) Pour le nettoyage de toutes les surfaces métalliques et plastiques, utiliser un chiffon souple et sec; G) La société Zafferano décline toute responsabilité pour les dommages provoqués par un produit monté de manière non conforme par rapport aux instructions.

#### 5. Attention:

- Le plan d'appui de la lampe ne doit pas dépasser 15° d'inclinaison, sinon elle risque de tomber.
- La batterie est fournie avec les protections suivantes: court-circuit, sous-charge, surcharge, surintensité, surtension.
- Pour préserver l'intégrité de la batterie, il est conseillé de maintenir la charge entre 20% minimum et 80% maximum; si la lampe n'est pas utilisée pendant de longues périodes, il est conseillé de procéder périodiquement à un cycle de charge/décharge du produit.
- Se référer aux lois locales pour une élimination correcte et le recyclage de la batterie.

## MODE D'EMPLOI

### Allumer / varier / éteindre

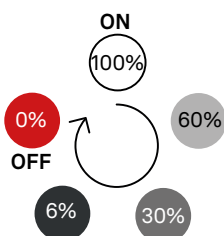
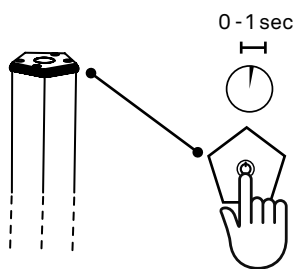

Toucher rapidement pour :

- allumer
- changer la luminosité
- éteindre le dispositif

La répétition des niveaux est cyclique.

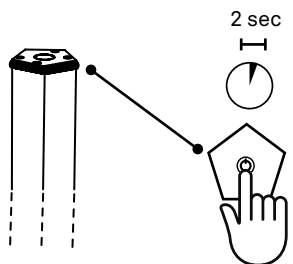

En appuyant sur le touch pendant deux secondes, la lampe s'éteint en mémorisant le niveau de réglage dimmer courant et en le repropasant lors du prochain allumage.

## TEMPÉRATURE DE COULEUR

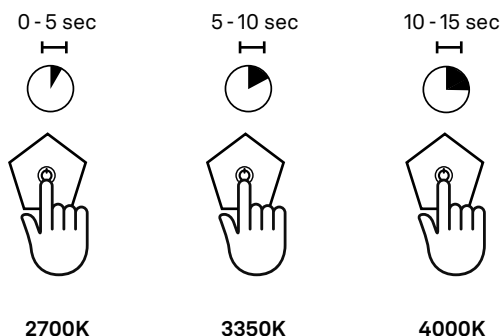

Lorsque la lampe est éteinte, appuyer sur le touch:

- après 5 secondes, elle s'allume à 2700K
- après 10 secondes, elle passe à 3350K
- après 15 secondes, elle passe à 4000K

En arrêtant de toucher pendant l'une des phases, la lampe mémorise le réglage de la phase courante.

Visitez notre site pour recevoir d'autres informations et des mises à jour sur les caractéristiques du produit

DESIGNED BY ZAFFERANO SRL IN ITALY, MADE IN PRC.

Zafferano srl, Viale dell'Industria, 26 - 31055 Quinto di Treviso - TV - Italie

[www.zafferanoitalia.com](http://www.zafferanoitalia.com)



## LED DE SIGNALISATION

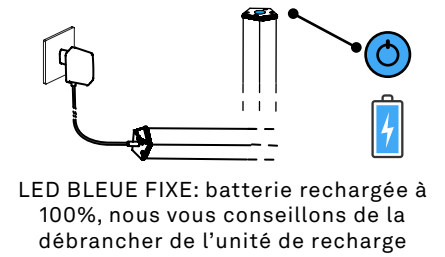
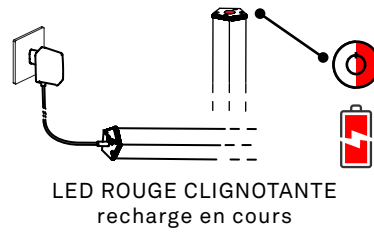
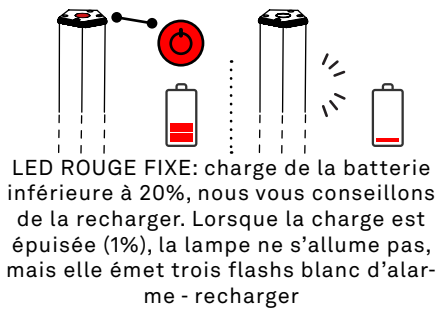

## RÉINSTALLATION DES PARAMÈTRES

Rétablissement de la configuration d'usine

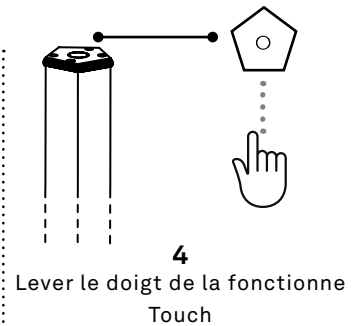
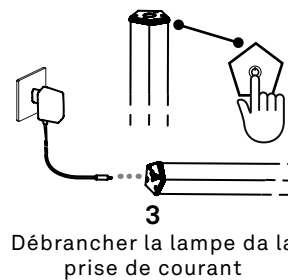
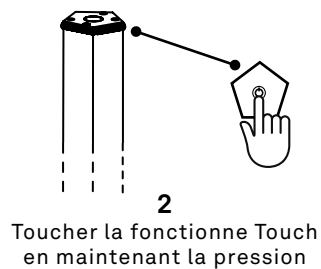
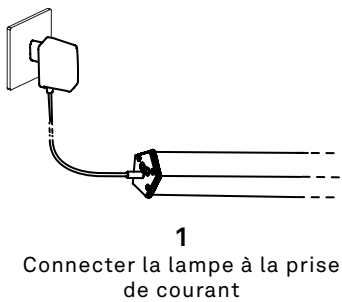

# Pencil

## Lámpara recargable



LED 2700 - 4000K / CRI≥90 / 100-240V IP65

DIMENSIONES	CÓDIGO	COLOR	WATT	LUMEN
h 146 x 5 cm / h 57,5 x 1,9 in	LD0802B3	blanco	LED: 16,5 MAX: 18	LED: 1860 lm (2700K) - 2100 lm (3350K) - 2340 lm (4000K) LÁMPARA: 1340 lm (2700K) - 1500 lm (3350K) - 1700 lm (4000K)
	LD0802N3	gris oscuro		
	LD0802R3	corten		
h 98 x 5 cm / h 38,6 x 1,9 in	LD0801B3	blanco	LED: 11 MAX: 12	LED: 1240 lm (2700K) - 1400 lm (3350K) - 1570 lm (4000K) LÁMPARA: 1050 lm (2700K) - 1180 lm (3350K) - 1350 lm (4000K)
	LD0801N3	gris oscuro		
	LD0801R3	corten		
h 46 x 5 cm / h 18,1 x 1,9 in	LD0800B3	blanco	LED: 5,5 MAX: 6	LED: 620 lm (2700K) - 700 lm (3350K) - 780 lm (4000K) LÁMPARA: 530 lm (2700K) - 590 lm (3350K) - 680 lm (4000K)
	LD0800N3	gris oscuro		
	LD0800R3	corten		

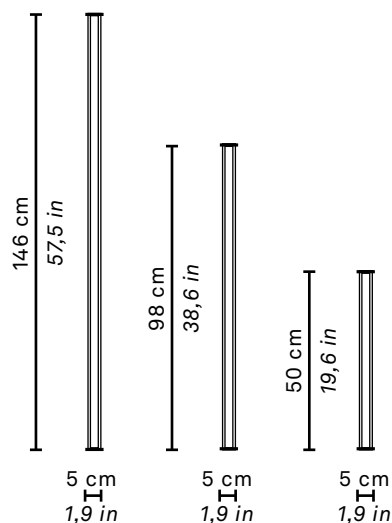

### 1. Datos técnicos:

- Voltios: 19 V
- LED: 4014 - 3 STEP MAC ADAM
- Batería de litio incluida: 26650 11,1Vdc (LD0802-- 15000mA/H; LD0801-- 10000mA/H; LD0800-- 5000mA/H);
- Recarga standard: 2,5A max;
- Recarga: LD0802-- 12 h; LD0801-- 9 h; LD0800-- 6 h;
- Duración de la batería: 100% 8 h - 60% 13 h - 30% 28 h - 6% 58 h
- Clase: III
- Grado de protección: IP65
- CRI≥90
- IK: 07









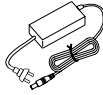

### 2. Cargador de baterías:

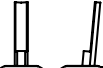
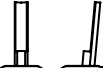
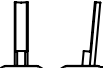
- Para cargar el producto es posible usar el cargador de baterías con enganche 3,5 - 1,3; DC 19 V; 3.16A max, NO INCLUIDO, se aconseja el uso de un cargador certificado.
- Para una carga correcta de la lámpara se aconseja: 1- conecte el cable al adaptador; 2- conecte el cable a la lámpara; 3- conecte el enchufe a la toma de corriente; 4- una vez completada la carga, retire el enchufe de la toma eléctrica y retire el cable.
- La lámpara funciona correctamente, aunque esté conectada a la corriente.

### 4. Configuración de fábrica:

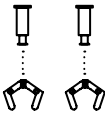
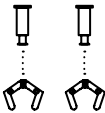
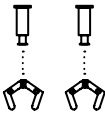
- BRILLO 100% - K 2700

### NO INCLUIDO

	<b>LD0800CS</b>	Cargador de baterías con enganche 3,5 - 1,3; input:100-240V; output: DC 19 V
	<b>LD081400</b>	Base para mesa en PMMA
	<b>LD0810B3</b>	Base para mesa o suelo de aluminio - blanco
	<b>LD0810N3</b>	Base para mesa o suelo de aluminio - gris oscuro
	<b>LD0810R3</b>	Base para mesa o suelo de aluminio - corten
	<b>LD0811B3</b>	Soporte para suspensión vertical de aluminio - blanco
	<b>LD0811N3</b>	Soporte para suspensión vertical de aluminio - gris oscuro
	<b>LD0811R3</b>	Soporte para suspensión vertical de aluminio - corten
	<b>LD0812B3</b>	Soportes para suspensión horizontal de aluminio - blanco
	<b>LD0812N3</b>	Soportes para suspensión horizontal de aluminio - gris oscuro
	<b>LD0812R3</b>	Soportes para suspensión horizontal de aluminio - corten
	<b>LD0813B3</b>	Soportes para pared de aluminio - blanco
	<b>LD0813N3</b>	Soportes para pared de aluminio - gris oscuro
	<b>LD0813R3</b>	Soportes para pared de aluminio - corten

LED NO REEMPLAZABLE



Visite nuestro sitio web para más informaciones y actualizaciones sobre las características del producto

DESIGNED BY ZAFFERANO SRL IN ITALY, MADE IN PRC.

Zafferano srl, Viale dell'Industria, 26 - 31055 Quinto di Treviso - tv - Italia

www.zafferanoitalia.com



#### 4. Consejos de uso:

Este producto debe utilizarse exclusivamente para iluminación y:

A) No debe ser expuesto a cargas mecánicas pesadas o contaminaciones fuertes; B) solo puede ser instalado y utilizado previo control de las condiciones del producto; verificar que no resulte estar sucio y no ha haya sido dañado durante el almacenamiento; C) la instalación y el mantenimiento deben realizarse con el aparato apagado; D) las modificaciones o las manipulaciones del producto y el incumplimiento de las indicaciones mostradas pueden hacer que el aparato sea peligroso; E) los productos con grado de protección 65 (IP65) son adecuados para uso externo; F) para la limpieza de todas las superficies metálicas y de plástico utilizar un paño suave y seco; G) La empresa Zafferano declina cualquier responsabilidad por los daños causados por un producto suyo montado de manera no conforme con las instrucciones.

#### 5. Atención:

- La superficie de apoyo de la lámpara no debe superar los 15° de inclinación para evitar su caída.
- La batería se entrega con las siguientes protecciones: cortocircuito, sobredescarga, sobrecarga, sobrecorriente, sobretensión.
- Para preservar la integridad de la batería se aconseja mantener la carga entre un mínimo del 20% y un máximo del 80%; si la lámpara no se utiliza durante períodos prolongados se aconseja realizar periódicamente un ciclo de carga/descarga del producto.
- Remítase a las normativas de ley locales para una eliminación y reciclaje correctos de la batería.

## INSTRUCCIONES DE USO

### Encendido / atenuación / apagado

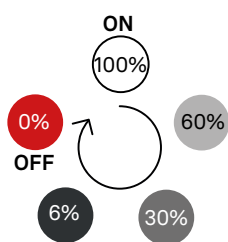
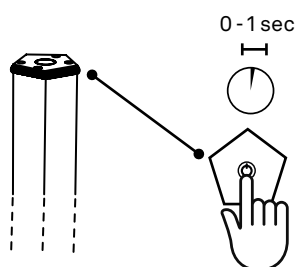

Toques rápidos para:  
- encender  
- cambiar la luminosidad  
- apagar el dispositivo  
La repetición de los pasos es cíclica.

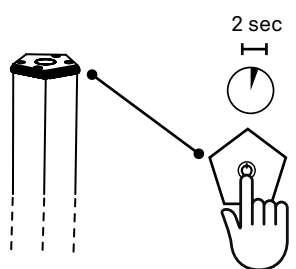

Manteniendo apretado el toque durante dos segundos, la lámpara se apaga memorizando el paso de atenuación actual y proponiéndolo otra vez en el siguiente encendido.

## TEMPERATURA DEL COLOR

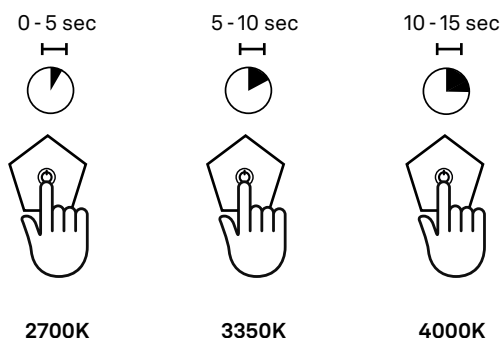

Con la lámpara apagada, mantener apretado el toque:  
- después de 5 segundos se enciende a 2700K  
- después de 10 segundos pasa a 3350K  
- después de 15 segundos pasa a 4000K  
La repetición de los pasos es cíclica.

Interrumpiendo el paso durante una de las fases, la lámpara memoriza la configuración de la fase actual.



## LED DE SEÑALIZACIÓN

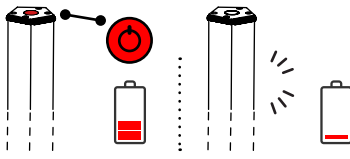

**LED ROJO FIJO** carga de la batería inferior al 20%, se recomienda recargar. Cuando la carga está agotada (1%), la lámpara no se enciende, sino que emite tres destellos blancos de alerta - recargar

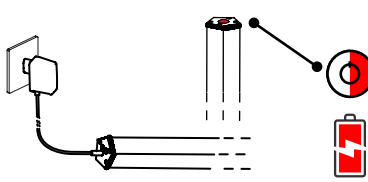

**LED ROJO INTERMITENTE** recarga en curso

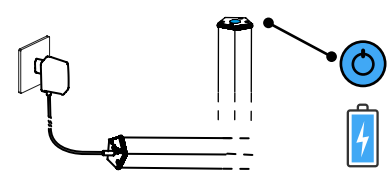

**LED AZUL FIJO** batería cargada al 100%, es aconsejable desconectar de la unidad de recarga

## RESTABLECIMIENTO DE LAS CONFIGURACIONES

Restablecimiento de la configuración de fábrica

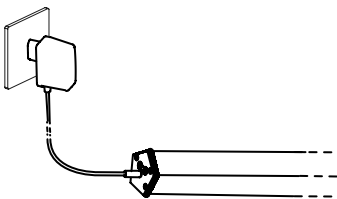

1

Conectar la lámpara a la toma de corriente

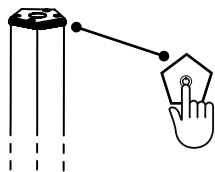

2

Apoyar el dedo en el elemento táctil manteniendo la presión

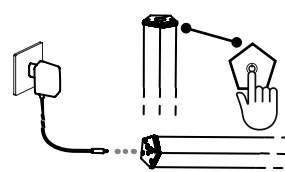

3

Desconectar la lámpara de la toma de corriente

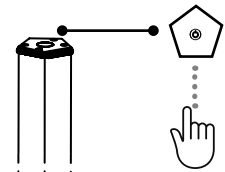



4

Levantar el dedo del elemento táctil

**ISTRUZIONI DI MONTAGGIO | ASSEMBLY INSTRUCTIONS | MONTAGEANLEITUNG | IN-  
STRUCTIONS DE MONTAGE | INSTRUCCIONES DE MONTAJE**

Lampada da tavolo o terra | table lamp and floor lamp | Tisch- oder Stehlampe |  
lampe de table ou de sol | ámpara de mesa o suelo

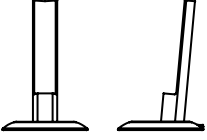
NON INCLUSO | NOT INCLUDED | NICHT ENTHALTEN |  
NON INCLUS | NO INCLUIDO

	LD0810B3	Base per tavolo o terra in alluminio   Base for table lamp or floor lamp in aluminium   Tischlampen- oder Stehlampenfuß aus Aluminium   Base pour table ou pour sol en aluminium   Base para mesa o suelo de aluminio		LD0800CS	Caricabatterie con attacco 3,5 - 1,3   Battery charger with a 3.5 - 1.3 connector   Ladegerät mit 3,5 - 1,3-Anschluss   Chargeur de batterie avec attache 3,5 - 1,3   Cargador de baterías con enganche 3,5 - 1,3
	LD0810N3				
	LD0810R3				

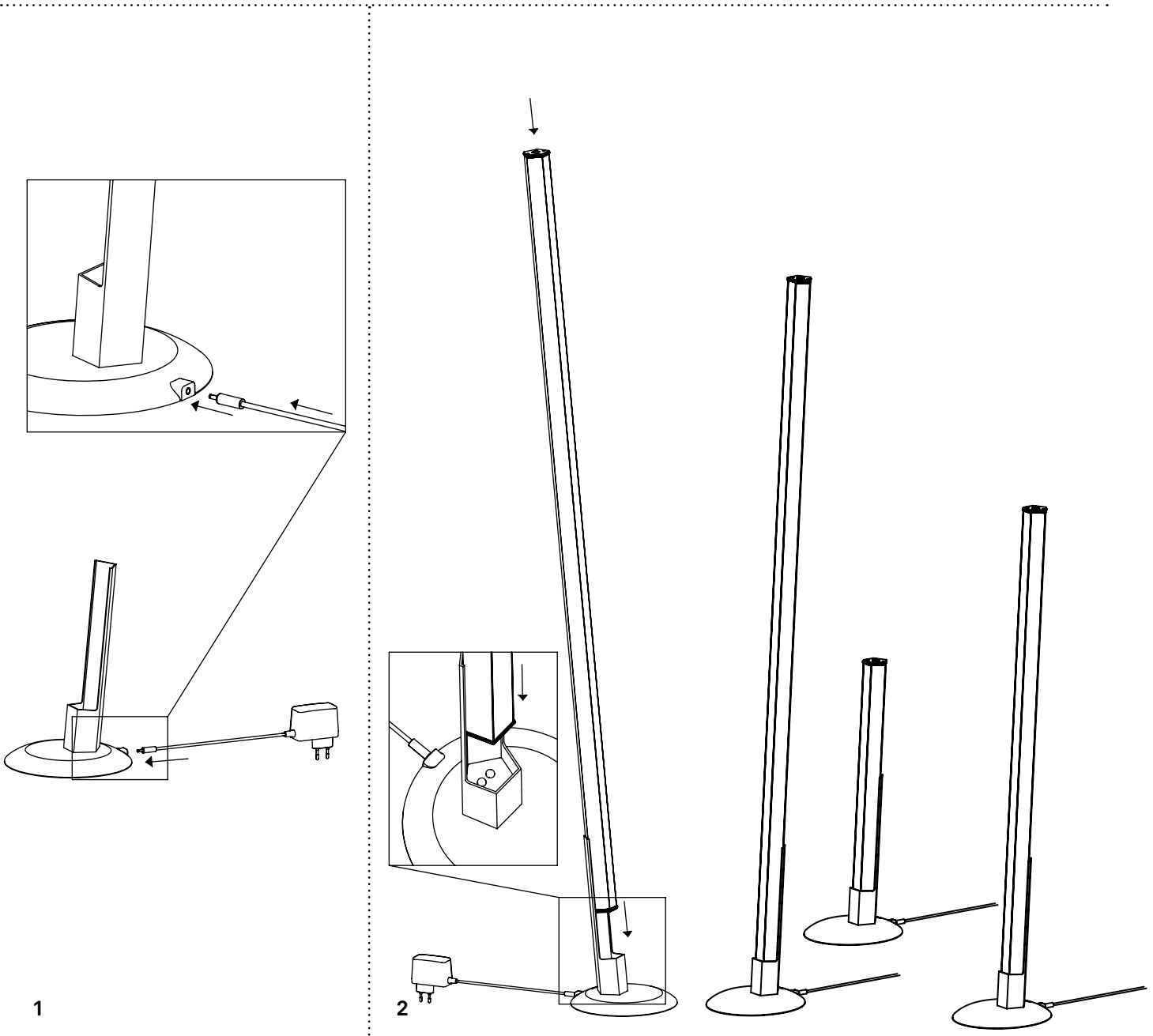

Visita il nostro sito per ulteriori informazioni, e aggiornamenti sulle caratteristiche del prodotto. | For more information and updates visit our website | Zu weiteren Informationen und Aktualisierungen der Produktkennzeichen besuchen Sie bitte unsere Webseite | Visitez notre site pour recevoir d'autres informations et des mises à jour sur les caractéristiques du produit | Visite nuestro sitio web para más informaciones y actualizaciones sobre las características del producto.

DESIGNED BY ZAFFERANO SRL IN ITALY, MADE IN PRC.

Zafferano srl, Viale dell'Industria, 26 - 31055 Quinto di Treviso - TV - Italia

www.zafferanoitalia.com

Lampada da tavolo | table lamp | Tischlampe | lampe de table | lámpara de mesa

NON INCLUSO | NOT INCLUDED | NICHT ENTHALTEN |  
NON INCLUS | NO INCLUIDO

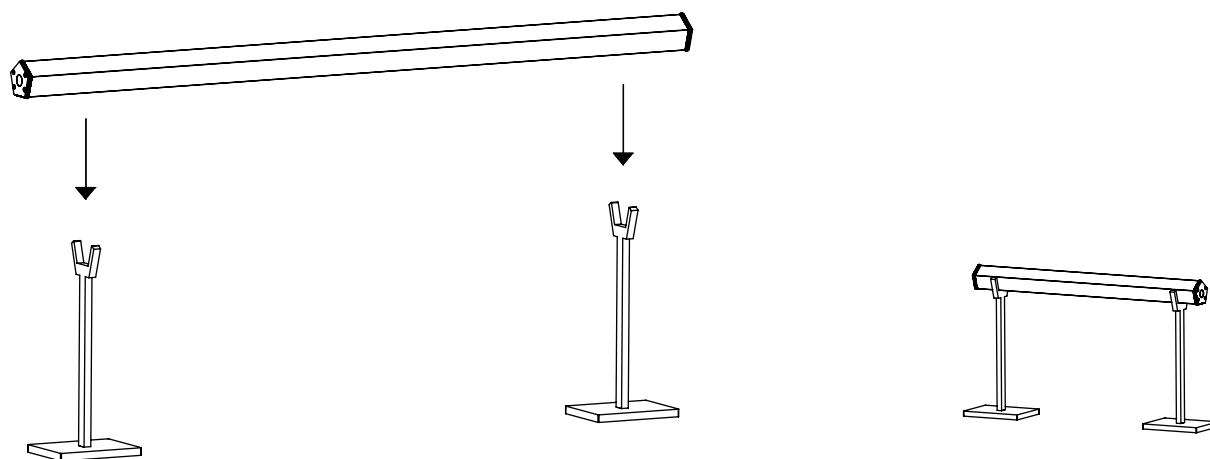
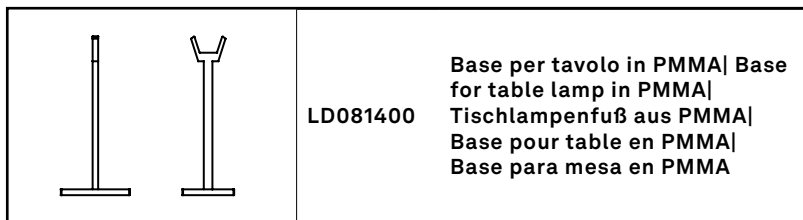

Orientamento del fascio luminoso  
Light beam direction  
Ausrichtung des Lichtstrahls  
Orientation du faisceau lumineux  
Orientación del haz luminoso

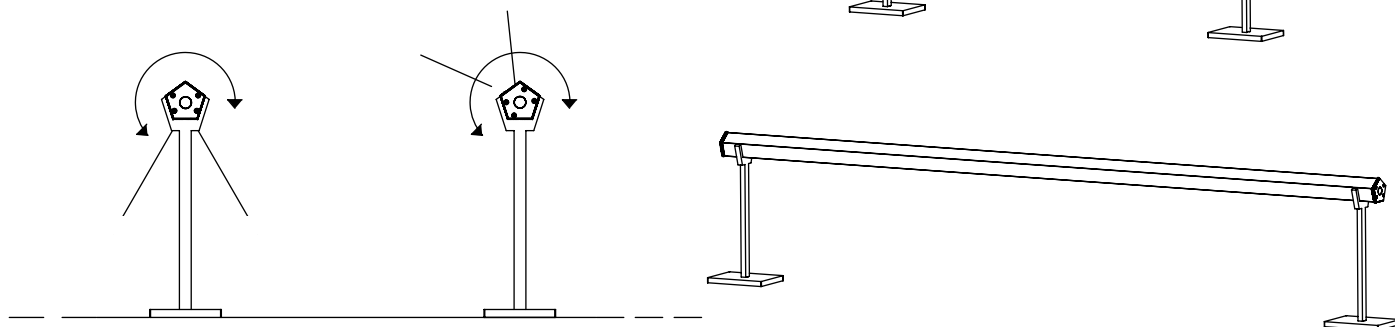

1



Visita il nostro sito per ulteriori informazioni, e aggiornamenti sulle caratteristiche del prodotto. | For more information and updates visit our website | Zu weiteren Informationen und Aktualisierungen der Produktkennzeichen besuchen Sie bitte unsere Webseite | Visitez notre site pour recevoir d'autres informations et des mises à jour sur les caractéristiques du produit | Visite nuestro sitio web para más informaciones y actualizaciones sobre las características del producto.

DESIGNED BY ZAFFERANO SRL IN ITALY, MADE IN PRC.  
Zafferano srl, Viale dell'Industria, 26 - 31055 Quinto di Treviso - TV - Italia  
[www.zafferanoitalia.com](http://www.zafferanoitalia.com)

Sospensione verticale | vertical pendant lamp | vertikale Aufhängung |  
suspension verticale | suspensión vertical

NON INCLUSO | NOT INCLUDED | NICHT ENTHALTEN |  
NON INCLUS | NO INCLUIDO

		LD0811B3	Staffa in alluminio con cavo in acciaio regolabile (h max 5 m) per sospensione  Aluminium bracket with adjustable steel cable (max. H. 5 m) for pendant lamp  Aluminiumbügel mit regulierbarem Stahlseil (h max. 5 m) zur Aufhängung  Etrier en aluminium avec câble en acier réglable (h max. 5 m) pour suspension  Soporte de aluminio con cable de acero ajustable (h máx. 5 m) para suspensión
		LD0811N3	
		LD0811R3	

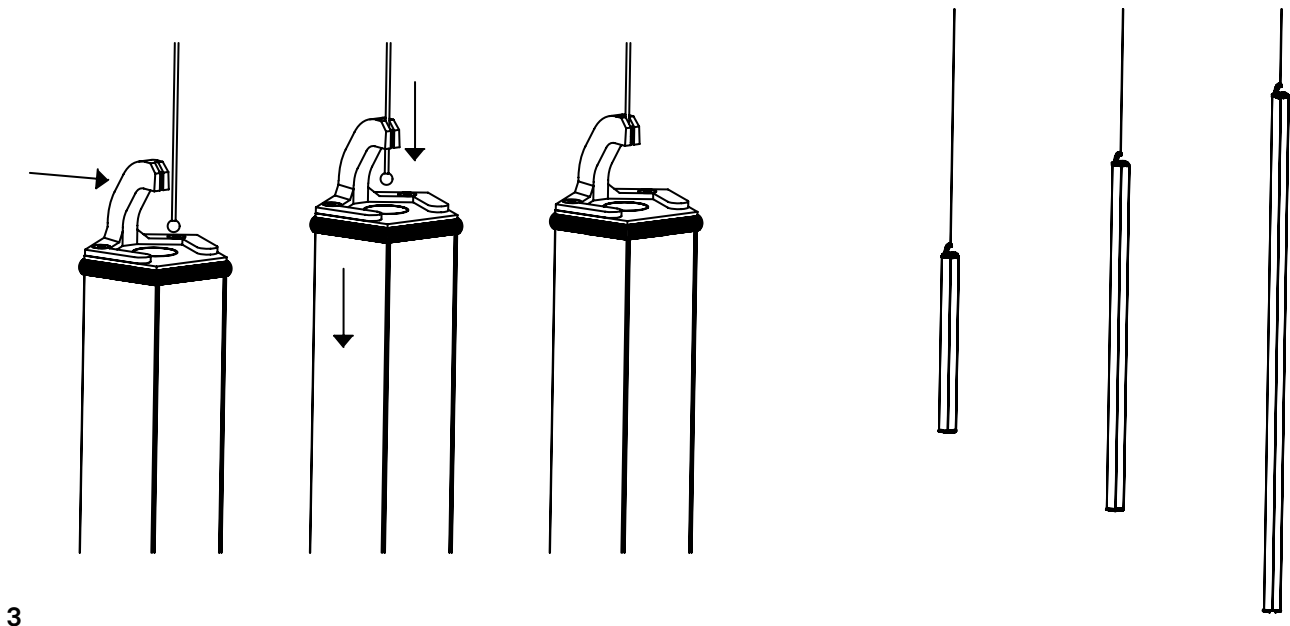
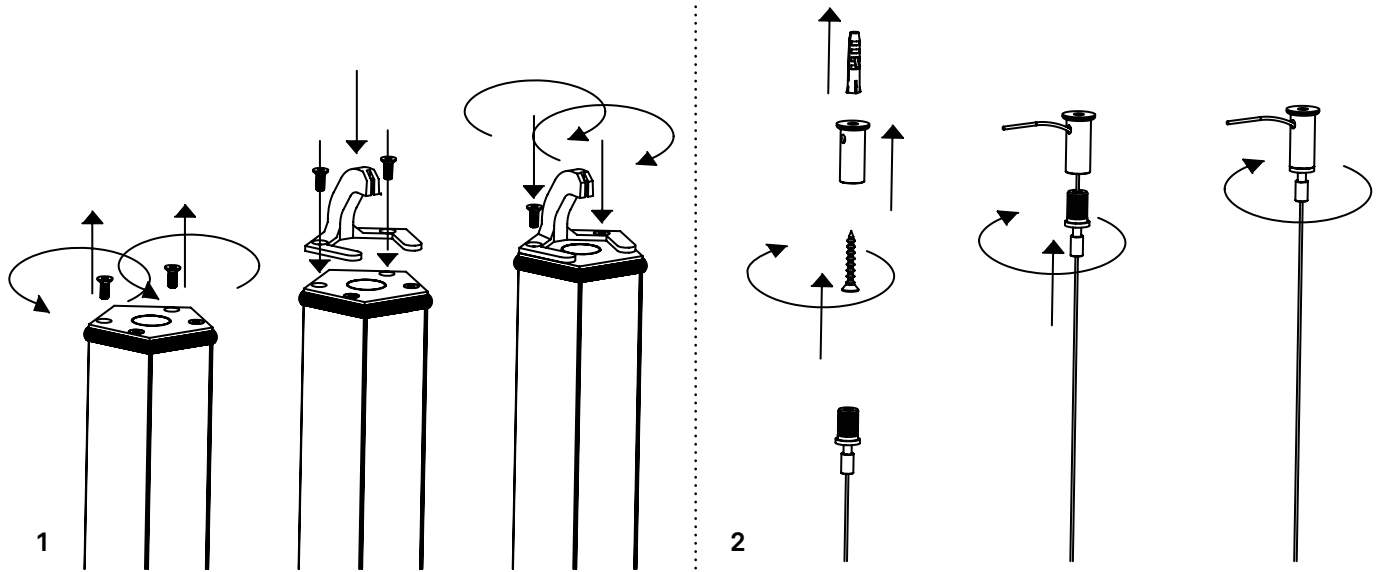

Visita il nostro sito per ulteriori informazioni, e aggiornamenti sulle caratteristiche del prodotto. | For more information and updates visit our website | Zu weiteren Informationen und Aktualisierungen der Produktkennzeichen besuchen Sie bitte unsere Webseite | Visitez notre site pour recevoir d'autres informations et des mises à jour sur les caractéristiques du produit | Visite nuestro sitio web para más informaciones y actualizaciones sobre las características del producto.

Sospensione orizzontale | horizontal pendant lamp | horizontale Aufhängung |  
suspension horizontale | suspensión horizontal

NON INCLUSO | NOT INCLUDED | NICHT ENTHALTEN |  
NON INCLUS | NO INCLUIDO

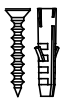
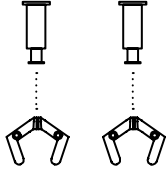
		<b>LD0812B3</b> Coppia di staffe in alluminio con cavo in acciaio regolabile (h max 5 m) per sospensione  Pair of aluminium brackets with adjustable steel cable (max. H. 5 m) for pendant lamp  Aluminiumbügelpaar mit regulierbarem Stahlseil (h max. 5 m) zur Aufhängung  Couple d'étriers en aluminium avec câble en acier réglable (h max. 5 m) pour suspension   Par de soportes de aluminio con cable de acero ajustable (h máx. 5 m) para suspensión
		<b>LD0812N3</b>
		<b>LD0812R3</b>

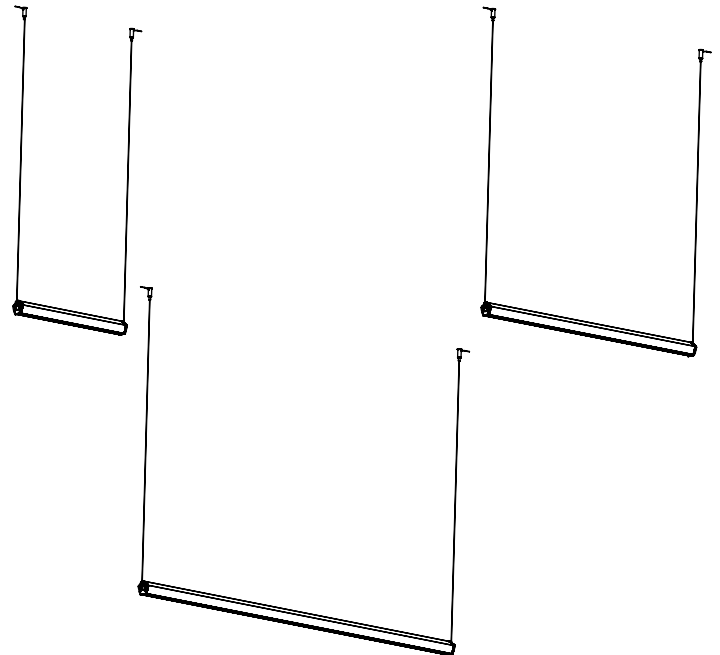
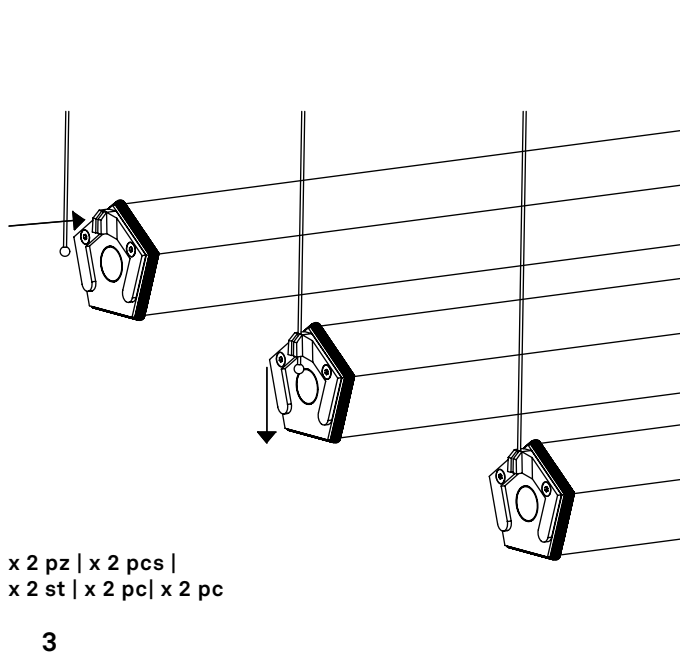
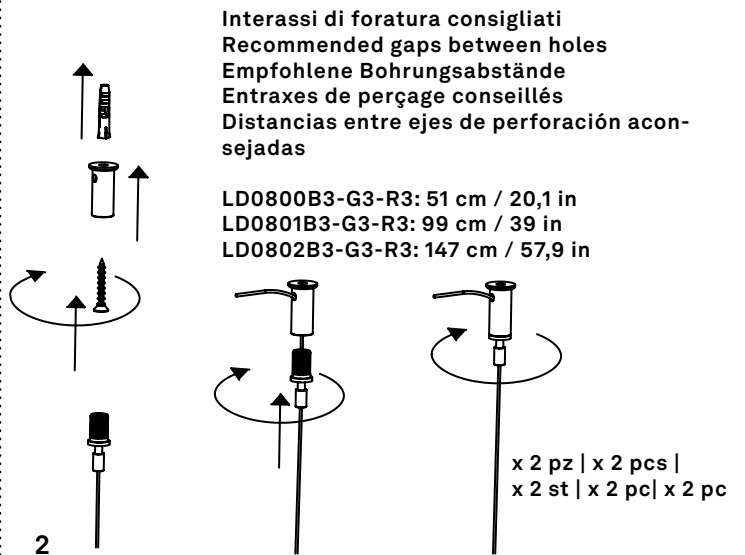
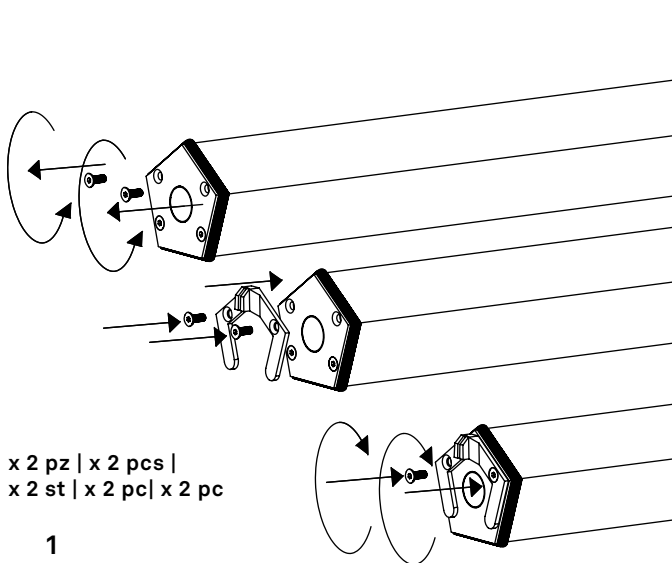

Visita il nostro sito per ulteriori informazioni, e aggiornamenti sulle caratteristiche del prodotto. | For more information and updates visit our website | Zu weiteren Informationen und Aktualisierungen der Produktkennzeichen besuchen Sie bitte unsere Webseite | Visitez notre site pour recevoir d'autres informations et des mises à jour sur les caractéristiques du produit | Visite nuestro sitio web para más informaciones y actualizaciones sobre las características del producto.



DESIGNED BY ZAFFERANO SRL IN ITALY, MADE IN PRC.

Zafferano srl, Viale dell'Industria, 26 - 31055 Quinto di Treviso - TV - Italia

www.zafferanoitalia.com

Lampada da parete | wall lamp | Wandlampe | lampe murale | lámpara de pared

NON INCLUSO | NOT INCLUDED | NICHT ENTHALTEN |  
NON INCLUS | NO INCLUIDO

		<b>LD0813B3</b> Coppia di staffe per parete in alluminio  Pair of aluminium brackets for wall lamp  Zwei Aluminium-Wandhalterungen
		<b>LD0813N3</b> Couple d'étriers en aluminium pour fixation murale  Par de soportes de aluminio para pared
		<b>LD0813R3</b>

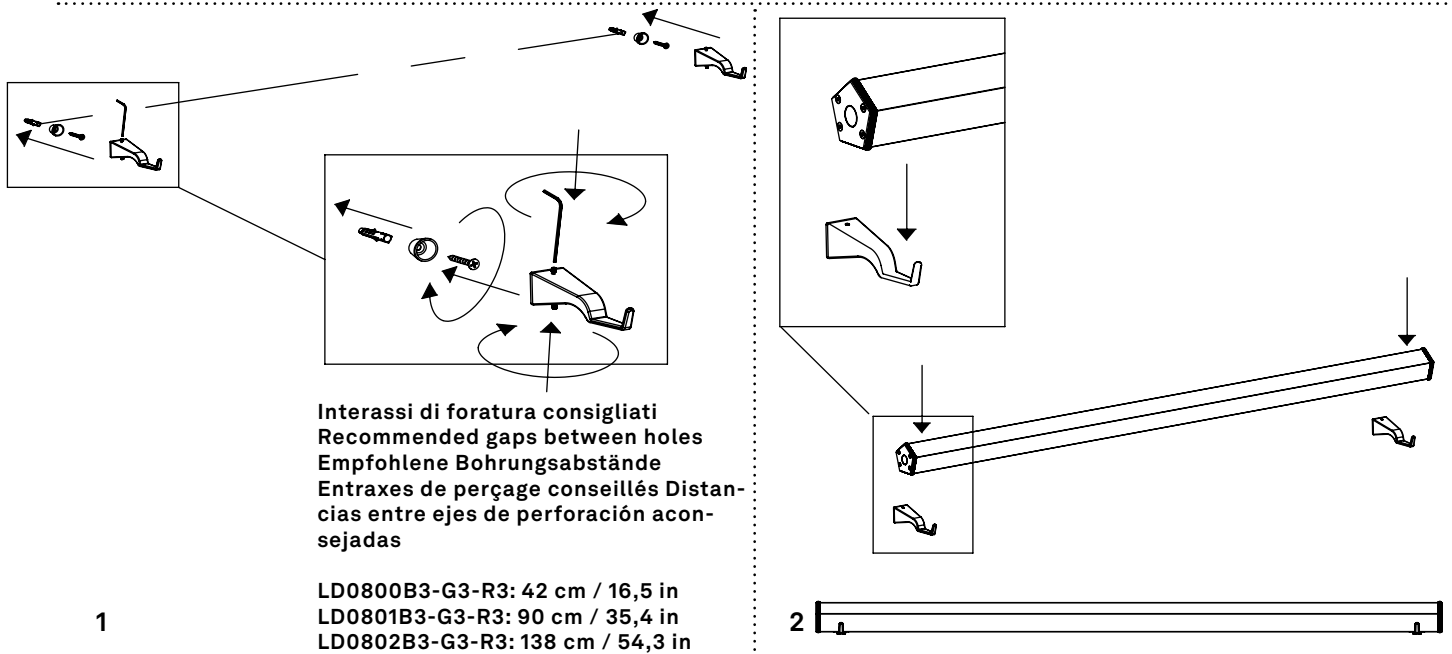

Orientamento del fascio luminoso  
Light beam direction  
Ausrichtung des Lichtstrahls  
Orientation du faisceau lumineux  
Orientación del haz luminoso

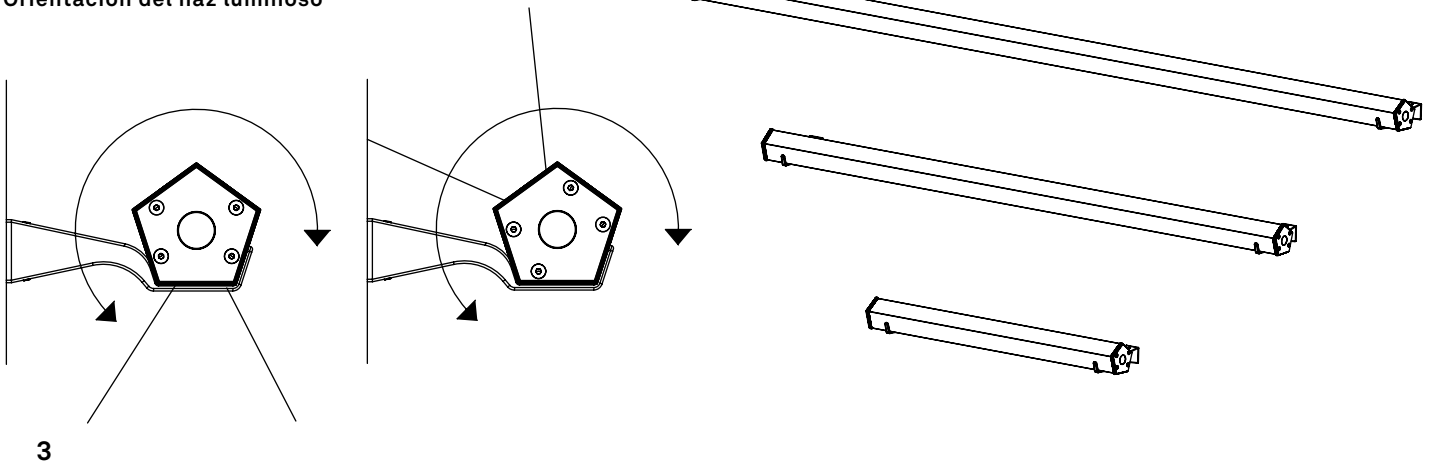

Visita il nostro sito per ulteriori informazioni, e aggiornamenti sulle caratteristiche del prodotto. | For more information and updates visit our website | Zu weiteren Informationen und Aktualisierungen der Produktkennzeichen besuchen Sie bitte unsere Webseite | Visitez notre site pour recevoir d'autres informations et des mises à jour sur les caractéristiques du produit | Visite nuestro sitio web para más informaciones y actualizaciones sobre las características del producto.

DESIGNED BY ZAFFERANO SRL IN ITALY, MADE IN PRC.

Zafferano srl, Viale dell'Industria, 26 - 31055 Quinto di Treviso - TV - Italia

www.zafferanoitalia.com



zafferano

LAMPES A PORTER



**Zafferano srl**

Viale dell'Industria, 26  
31055 - Quinto di Treviso - Italia  
T +39 0422 470507  
F +39 0422 470400  
lighting@zafferanoitalia.com

C.F 03420190260 - P.IVA IT 03305480273  
REA di TV n. 330102

[www.zafferanoitalia.com](http://www.zafferanoitalia.com)